



Wire & Cable > Wire & Cable Accessories > Cable Tie Mounts & Accessories



Wire & Cable Accessory Type: **Cable Tie Tool**

Primary Product Material: **Polyethylene**

Packaging Method: **Box**

Features

Product Type Features

| | |
|-----------------------------|----------------|
| Wire & Cable Accessory Type | Cable Tie Tool |
|-----------------------------|----------------|

Body Features

| | |
|--------------------------|--------------|
| Primary Product Material | Polyethylene |
|--------------------------|--------------|

Packaging Features

| | |
|------------------|-----|
| Packaging Method | Box |
|------------------|-----|

Product Compliance

[For compliance documentation, visit the product page on TE.com>](#)

| | |
|---|---|
| EU RoHS Directive 2011/65/EU | Compliant |
| EU ELV Directive 2000/53/EC | Compliant |
| China RoHS 2 Directive MIIT Order No 32, 2016 | No Restricted Materials Above Threshold |
| EU REACH Regulation (EC) No. 1907/2006 | Current ECHA Candidate List: JUNE 2023 (235) Candidate List Declared Against: JUNE 2022 (224) Does not contain REACH SVHC |
| Halogen Content | Low Halogen - Br, Cl, F, I < 900 ppm per homogenous material. Also BFR/CFR/PVC Free |













Solder Process Capability

Not applicable for solder process capability

Product Compliance Disclaimer

This information is provided based on reasonable inquiry of our suppliers and represents our current actual knowledge based on the information they provided. This information is subject to change. The part numbers that TE has identified as EU RoHS compliant have a maximum concentration of 0.1% by weight in homogenous materials for lead, hexavalent chromium, mercury, PBB, PBDE, DBP, BBP, DEHP, DIBP, and 0.01% for cadmium, or qualify for an exemption to these limits as defined in the Annexes of Directive 2011/65/EU (RoHS2). Finished electrical and electronic equipment products will be CE marked as required by Directive 2011/65/EU. Components may not be CE marked. Additionally, the part numbers that TE has identified as EU ELV compliant have a maximum concentration of 0.1% by weight in homogenous materials for lead, hexavalent chromium, and mercury, and 0.01% for cadmium, or qualify for an exemption to these limits as defined in the Annexes of Directive 2000/53/EC (ELV). Regarding the REACH Regulation, the information TE provides on SVHC in articles for this part number is based on the latest European Chemicals Agency (ECHA) 'Guidance on requirements for substances in articles' posted at this URL: <https://echa.europa.eu/guidance-documents/guidance-on-reach>

Compatible Parts

| | | | |
|--|---|---|---|
|  <p>TE Part # 500017-1 SPIRAP 1/2", NYLON, NAT, 50 FT</p> |  <p>TE Part # 500031-1 SPIRAP 1/2" PE, OUTDR, BLK, 50 FT</p> |  <p>TE Part # 500030-1 SPIRAP 1/4" PE, OUTDR, BLK, 50 FT</p> |  <p>TE Part # 500015-1 SPIRAP 1/4", NYLON, NAT, 50 FT</p> |
|  <p>TE Part # 500000-2 SPIRAP, 1/8" PE, NAT, 100 FT</p> |  <p>TE Part # 500001-1 SPIRAP 1/4" PE, NAT, 50 FT</p> |  <p>TE Part # 500002-1 SPIRAP 1/2" PE, NAT, 50 FT</p> |  <p>TE Part # 500004-1 SPIRAP 1/4" FR PE, WHITE, 50 FT</p> |
|  <p>TE Part # 142831-1 TUBING SPIRAP 500002-1</p> |  <p>TE Part # 142830-2 TUBING SPIRAP DIA 6 NAT 30 METERS</p> |  <p>TE Part # 500013-2 SPIRAP, 1/8" NYLON, NAT, 100 FT</p> |  <p>TE Part # 142841-1 TUBING SPIRAP 500031-1</p> |



Customers Also Bought

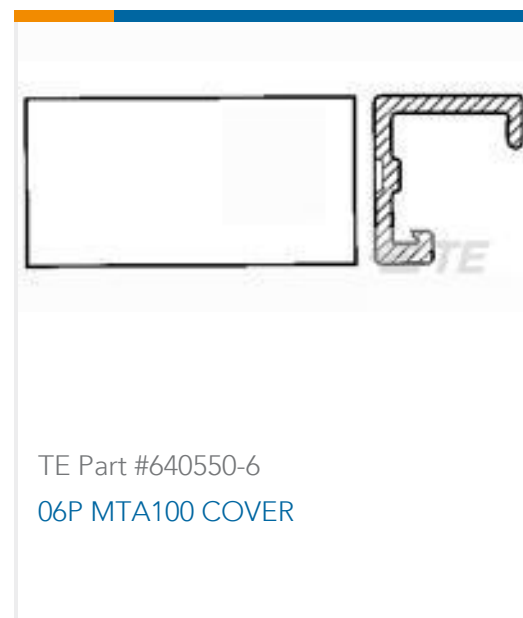

Documents



CAD Files

3D PDF

3D

Customer View Model

[ENG_CVM_CVM_500901_F.2d_dxf.zip](#)

English

Customer View Model

[ENG_CVM_CVM_500901_F.3d_igs.zip](#)

English

Customer View Model

[ENG_CVM_CVM_500901_F.3d_stp.zip](#)

English

By downloading the CAD file I accept and agree to the [Terms and Conditions](#) of use.

Instruction Sheets

Instruction Sheet (U.S.)

English