

5-1969352-2 ✓ ACTIVE

[RAST](#) | [RAST 5 IDC Connectors](#)

TE Internal #: 5-1969352-2

PCB Mount Header, Right Angle, Wire-to-Board, 2 Position, 5 mm [.

197 in] Centerline, Fully Shrouded, Tin, Through Hole - Solder,

RAST 5 IDC Connectors

[View on TE.com >](#)



[Connectors](#) > [PCB Connectors](#) > [PCB Headers & Receptacles](#)

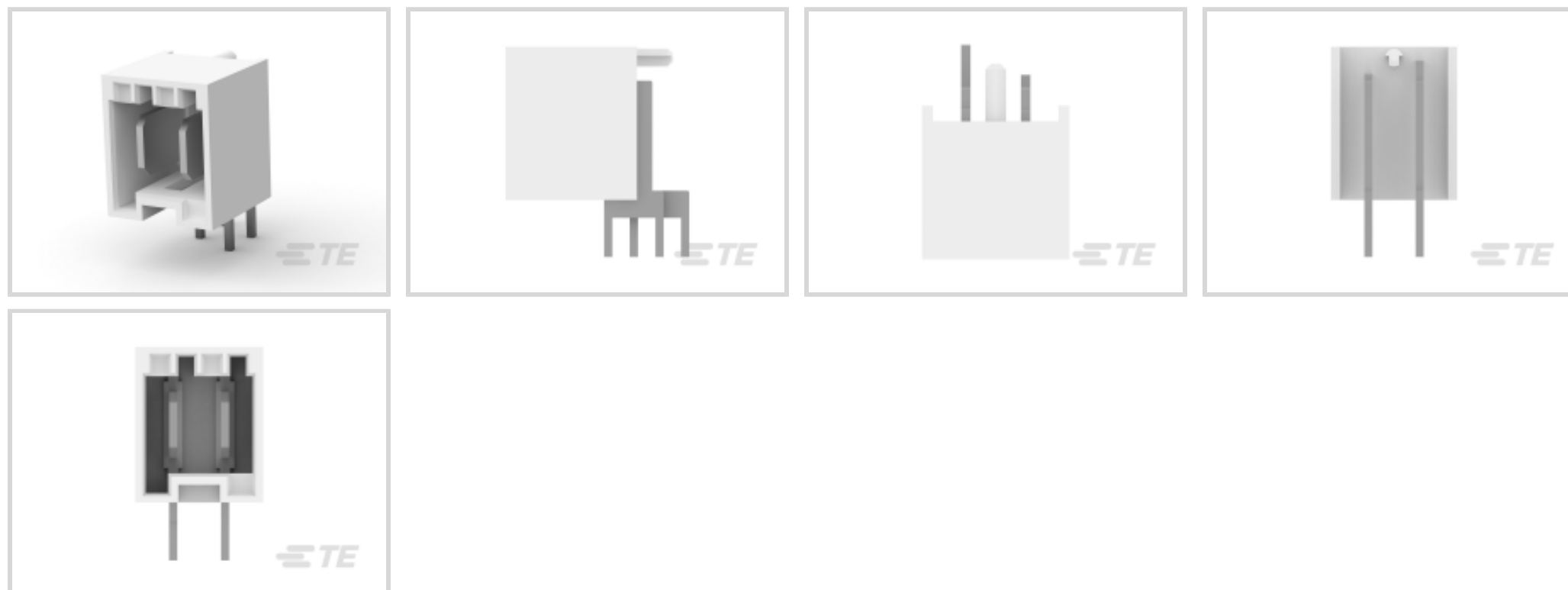

Connector System: **Wire-to-Board**

Number of Positions: **2**

Number of Rows: **1**

Centerline (Pitch): **5 mm [.197 in]**

PCB Mount Orientation: **Right Angle**

Features

Product Type Features

Connector System	Wire-to-Board
Header Type	Fully Shrouded
Sealable	No
Connector & Contact Terminates To	Printed Circuit Board
PCB Connector Assembly Type	PCB Mount Header

Configuration Features

Keying & Polarized Position Locations	1C
Number of Positions	2
Number of Rows	1
PCB Mount Orientation	Right Angle

Electrical Characteristics

Operating Voltage	250 VAC
-------------------	---------

Body Features

Primary Product Color	Natural
-----------------------	---------



Contact Features

PCB Contact Termination Area Plating Material Thickness	3.8 μm [149.6 μin]
Contact Layout	Inline
Mating Tab Width	6.3 mm[.248 in]
Mating Tab Thickness	.8 mm[.032 in]
Contact Underplating Material Thickness	1.3 μm [51.18 μin]
Contact Mating Area Plating Material Thickness	3.8 μm [149.6 μin]
PCB Contact Termination Area Plating Material Finish	Matte
Contact Mating Area Plating Material Finish	Matte
Contact Underplating Material	Nickel
PCB Contact Termination Area Plating Material	Tin
Contact Base Material	Brass
Contact Mating Area Plating Material	Tin
Contact Type	Tab
Contact Current Rating (Max)	16 A

Termination Features

Square Termination Post & Tail Dimension	.8 mm[.032 in]
Termination Post & Tail Length	3.8 mm[.14 in]
Termination Method to Printed Circuit Board	Through Hole - Solder

Mechanical Attachment

PCB Mount Alignment Type	Boss
Mating Alignment Type	Keyed, Polarization
Mating Retention	With
Panel Mount Feature	Without
Connector Mounting Type	Board Mount
Mating Alignment	With
PCB Mount Alignment	With
PCB Mount Retention	Without

Housing Features

Housing Material	PA 6 Nylon
Centerline (Pitch)	5 mm[.197 in]

Dimensions



Connector Length	12.3 mm[.48 in]
Connector Height	14.9 mm[.58 in]
Connector Width	17.9 mm[.705 in]
PCB Thickness (Recommended)	1.5 mm[.059 in]

Usage Conditions

Operating Temperature Range	-40 – 105 °C[-40 – 221 °F]
-----------------------------	----------------------------

Operation/Application

Circuit Application	Power
---------------------	-------

Industry Standards

Agency/Standard	UL
Approved Standards	UL E28476
UL Flammability Rating	UL 94V-2

Packaging Features

Packaging Quantity	208
Packaging Type	Tray

Product Compliance

[For compliance documentation, visit the product page on TE.com>](#)

EU RoHS Directive 2011/65/EU	Compliant
EU ELV Directive 2000/53/EC	Compliant
China RoHS 2 Directive MIIT Order No 32, 2016	No Restricted Materials Above Threshold
EU REACH Regulation (EC) No. 1907/2006	Current ECHA Candidate List: JUNE 2023 (235) Candidate List Declared Against: JUNE 2023 (235) Does not contain REACH SVHC
Halogen Content	Not Low Halogen - contains Br or Cl > 900 ppm.
Solder Process Capability	Not reviewed for solder process capability

Product Compliance Disclaimer

This information is provided based on reasonable inquiry of our suppliers and represents our current actual knowledge based on the information they provided. This information is subject to change. The part numbers that TE has identified as EU RoHS compliant have a maximum concentration of 0.1% by weight in homogenous materials for lead, hexavalent chromium, mercury, PBB, PBDE, DBP, BBP, DEHP, DIBP, and 0.01% for cadmium, or qualify for an exemption to these limits as defined in the Annexes of Directive 2011/65/EU (RoHS2). Finished electrical and electronic equipment products will be CE marked as required by Directive 2011/65/EU. Components may not be CE marked. Additionally, the part numbers that TE has identified as EU ELV compliant have a maximum concentration of 0.1% by weight in homogenous

materials for lead, hexavalent chromium, and mercury, and 0.01% for cadmium, or qualify for an exemption to these limits as defined in the Annexes of Directive 2000/53/EC (ELV). Regarding the REACH Regulation, the information TE provides on SVHC in articles for this part number is based on the latest European Chemicals Agency (ECHA) 'Guidance on requirements for substances in articles' posted at this URL: <https://echa.europa.eu/guidance-documents/guidance-on-reach>

Compatible Parts



TE Part # 521384-2
ASSY PL R/A RAST5 HEADER 02-A



TE Part # 1969352-2
ASSY DIN R/A RAST5 HDR 02-A, G



TE Part # 3-521384-2
ASSY PL R/A RAST5 HEADER 02-E



TE Part # 1-521384-2
ASSY PL R/A RAST5 HEADER 02-B

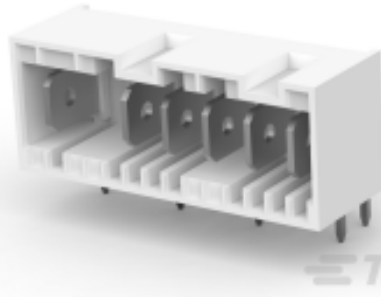

TE Part # 1955660-7
RAST 5,HSG,7P,RIGHT ANGLE, GWT



TE Part # 2-521384-2
ASSY PL R/A RAST5 HEADER 02-C



TE Part # 4-521384-2
ASSY PL R/A RAST5 HEADER 02-G



TE Part # 5-521384-2
ASSY PL R/A RAST5 HEADER 02-I



TE Part # 5-521385-2
ASSY DIN R/A RAST5 HEADER 02-I



TE Part # 521386-4
ASSY PL R/A RAST5 HDR 4P SP



TE Part # 6-521384-2
ASSY PL R/A RAST5 HEADER 2P

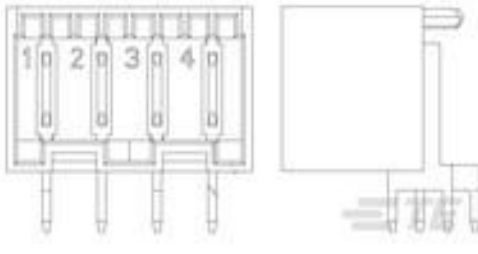

TE Part # 2178618-3
ASSY DIN R/A RAST5 HEADER 03-A

Also in the Series | RAST 5 IDC Connectors



Automotive Terminals(8)



Connector Contacts(12)

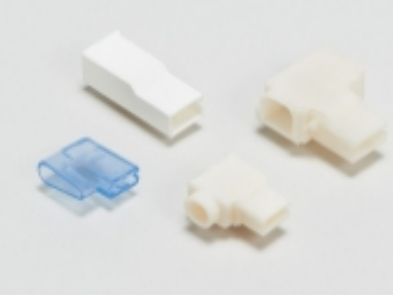

Crimp Terminal Housings(41)



Insertion & Extraction Tools(1)



PCB Headers & Receptacles(417)



Rectangular Connector Housings(1)

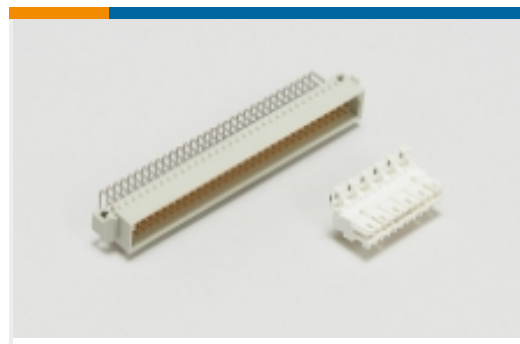

Standard Edge Connectors(34)



Standard Rectangular Connectors(68)



Wire-to-Board Connector Assemblies & Housings(214)



Wire-to-Board Connector Contacts(2)

Customers Also Bought



TE Part #4-1879073-8
THS10 5K6 5%



TE Part #1-480701-2
03P UMNL CAP HSG RED

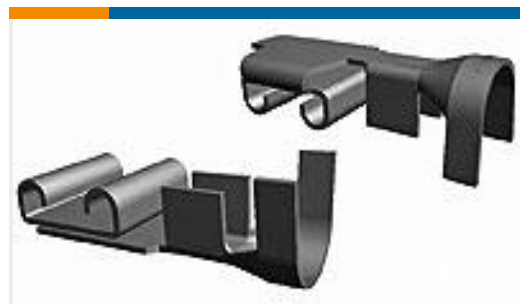

TE Part #62048-2
250 FASTON REC 18-14 AWG TPBR

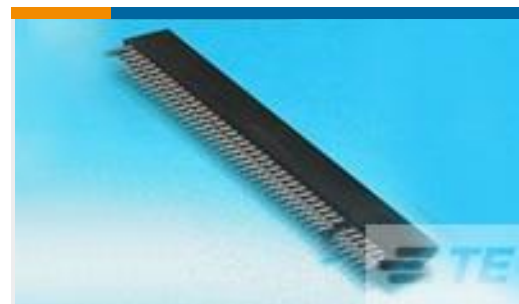

TE Part #7-5530843-7
CONN SEC II 3 POS 100C/L



TE Part #1565917-4
EMBOSS ASSY DDR2 SODIMM
SOCKET 200P 5.2H

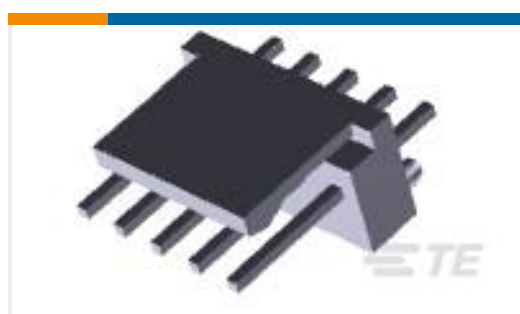

TE Part #3-647609-5
05P MTA100 HDR ASSY F/L LF



TE Part #927742-2
2 POS FASTIN/ON HOUSING PANEL
MOUNT



TE Part #1-1721261-3
OJ-SH-112LMH2.000T0



TE Part #1721261-7
OJE-SS-112LMH2,000T0

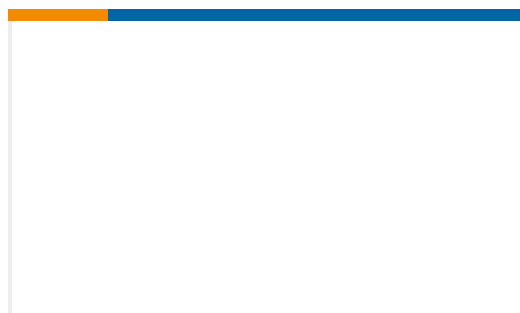

TE Part #1721923-6
OJE-SS-112HMF,000T0

Documents



Product Drawings

[ASSY DIN R/A RAST5 HDR 02-A, G](#)

English

CAD Files

[3D PDF](#)

3D

Customer View Model

[ENG_CVM_CVM_5-1969352-2_A_c-5-1969352-2-a.2d_dxf.zip](#)

English

Customer View Model

[ENG_CVM_CVM_5-1969352-2_A_c-5-1969352-2-a.3d_igs.zip](#)

English

Customer View Model

[ENG_CVM_CVM_5-1969352-2_A_c-5-1969352-2-a.3d_stp.zip](#)

English

By downloading the CAD file I accept and agree to the [Terms and Conditions](#) of use.

Product Specifications

[Product Specification](#)

English

Product Environmental Compliance

[Product Compliance](#)

English

[Product Compliance](#)

English

Agency Approvals

[UL Report](#)

English