

5-160667-2 ✓ ACTIVE

FASTIN-FASTON | FASTIN-FASTON 250

TE Internal #: 5-160667-2

Quick Disconnects, Receptacle, 20 – 15 AWG Wire Size, .51 – 1.65 mm² Wire Size, 1021 – 3256 CMA Wire Size, FASTIN-FASTON 250

[View on TE.com >](#)



Terminals & Splices > Quick Disconnects

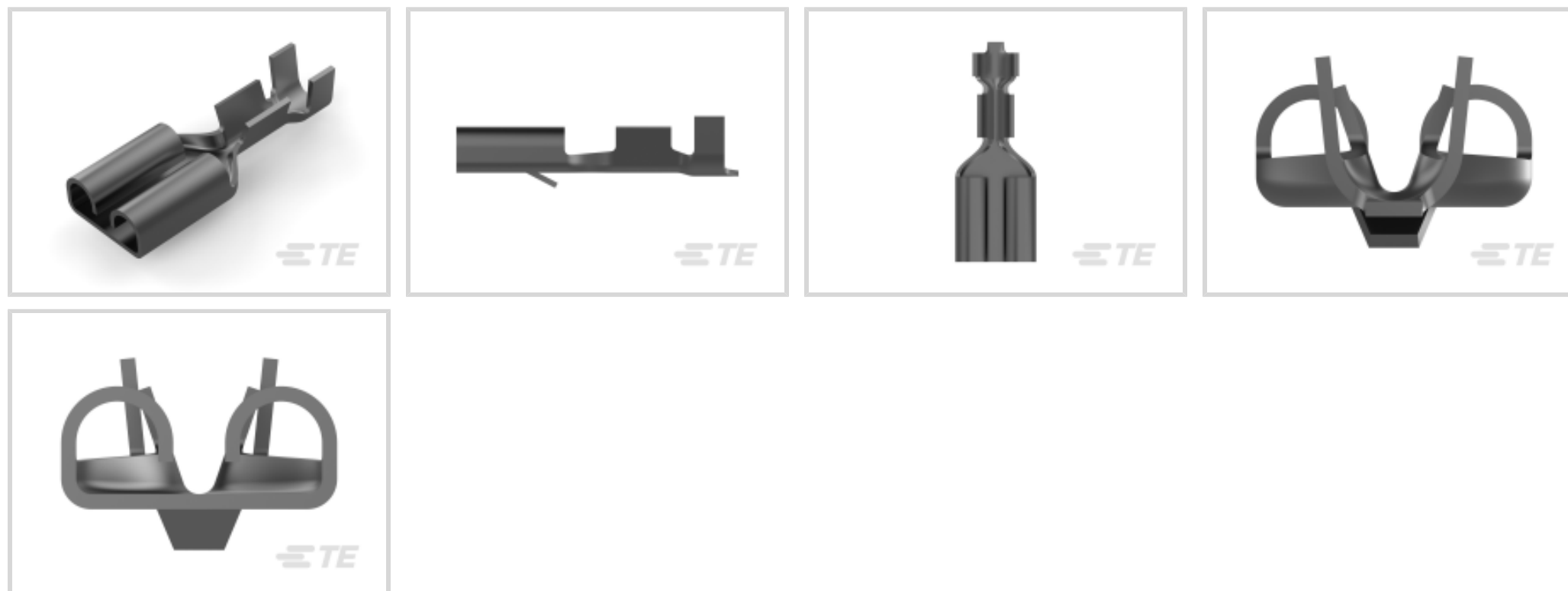

Quick Disconnect Terminal Type: **Receptacle**

Wire Size: **1021 – 3256 CMA**

Mating Tab Width: **6.35 mm [.25 in]**

Features

Configuration Features

Connection Capacity	Single
Compatible With Wire & Cable Type	Discrete Wire

Contact Features

Quick Disconnect Terminal Type	Receptacle
Mating Tab Width	6.35 mm[.25 in]
Mating Tab Thickness	.81 mm[.032 in]
Terminal Orientation	Straight
Contact Base Material	Brass
Terminal Plating Material	Tin
Crimp Type	F-Crimp
Barrel Type	Open

Termination Features

Product Terminates To	Wire & Cable
-----------------------	--------------

Mechanical Attachment

Locking Lance Height	1.2 mm[.047 in]
Wire Insulation Support	With



Mating Retention Type	Locking Lance
-----------------------	---------------

Dimensions

Terminal Material Thickness	.41 mm[.016 in]
Product Length	19.4 mm[.763 in]
Compatible Insulation Diameter Range	2.31 – 3.3 mm[.091 – .13 in]
Wire Size	1021 – 3256 CMA

Usage Conditions

Insulation Option	Uninsulated
Operating Temperature Range	-40 – 110 °C[-40 – 230 °F]

Packaging Features

Packaging Quantity	500
Packaging Method	Loose Piece/Carton

Other

Line	FASTON .250
------	-------------

Product Compliance

[For compliance documentation, visit the product page on TE.com>](#)

EU RoHS Directive 2011/65/EU	Compliant
EU ELV Directive 2000/53/EC	Compliant
China RoHS 2 Directive MIIT Order No 32, 2016	No Restricted Materials Above Threshold
EU REACH Regulation (EC) No. 1907/2006	Current ECHA Candidate List: JUNE 2023 (235) Candidate List Declared Against: JUNE 2023 (235) Does not contain REACH SVHC
Halogen Content	Low Halogen - Br, Cl, F, I < 900 ppm per homogenous material. Also BFR/CFR/PVC Free
Solder Process Capability	Not applicable for solder process capability

Product Compliance Disclaimer

This information is provided based on reasonable inquiry of our suppliers and represents our current actual knowledge based on the information they provided. This information is subject to change. The part numbers that TE has identified as EU RoHS compliant have a maximum concentration of 0.1% by weight in homogenous materials for lead, hexavalent chromium, mercury, PBB, PBDE, DBP, BBP, DEHP, DIBP, and 0.01% for cadmium, or qualify for an exemption to these limits as defined in the Annexes of Directive 2011/65/EU (RoHS2). Finished electrical and electronic equipment products will be CE marked as required by Directive 2011/65/EU. Components may not be CE marked. Additionally, the part numbers that TE has identified as EU ELV compliant have a maximum concentration of 0.1% by weight in homogenous materials for lead, hexavalent chromium, and mercury, and 0.01% for cadmium, or qualify for an exemption to these limits

as defined in the Annexes of Directive 2000/53/EC (ELV). Regarding the REACH Regulation, the information TE provides on SVHC in articles for this part number is based on the latest European Chemicals Agency (ECHA) 'Guidance on requirements for substances in articles' posted at this URL: <https://echa.europa.eu/guidance-documents/guidance-on-reach>

Compatible Parts



TE Part # 1-1579007-4
EXTRACTION TOOL



TE Part # 4-1579007-3
EXTRACTION TOOL KIT



TE Part # 42924-2
FF 250 REC 18-14AWG TPBR PRE CRIMPED

Also in the Series | FASTIN-FASTON 250

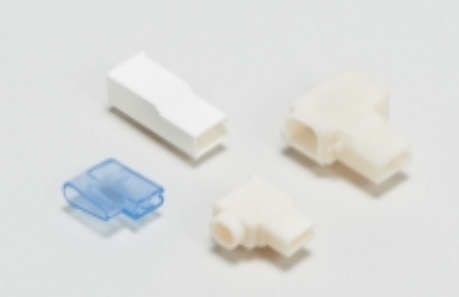

Crimp Terminal Housings(211)



Insertion & Extraction Tools(2)



PCB Terminals(2)



Quick Disconnects(254)

Customers Also Bought

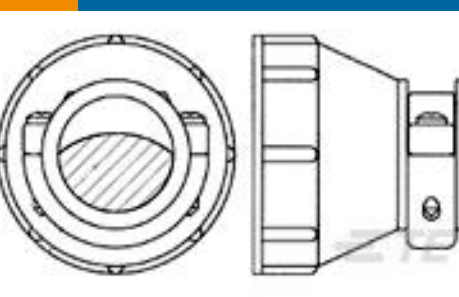

TE Part #182661-1
CPC Cable Clamp Kit, Size 17, Large, UV



TE Part #182642-1
CPC EMEA



TE Part #160831-3
250 PL MKI REC. 17-13AWG TPBR



TE Part #5-1625885-3
1W SM M/OX 5% 2K2



TE Part #1-1625886-8
1W SM M/OX 5% 470R



TE Part #927774-3
JPT REC 2.8 Contact SRC Sn



TE Part #495169-000
2018D0309-0



TE Part #374Z-03780
Speed sen DSF 1810.01 AHV (HDB 18 /12-S

Documents



Product Drawings

[FF 250 REC 0.5-1.5MM2 TPBR LP](#)

English

CAD Files

[3D PDF](#)

3D

Customer View Model

[ENG_CVM_CVM_5-160667-2_C.2d_dxf.zip](#)

English

Customer View Model

[ENG_CVM_CVM_5-160667-2_C.3d_igs.zip](#)

English

Customer View Model

[ENG_CVM_CVM_5-160667-2_C.3d_stp.zip](#)

English

By downloading the CAD file I accept and agree to the [Terms and Conditions](#) of use.