

5-160321-2 ✓ ACTIVE

FASTON | FASTON 110

TE Internal #: 5-160321-2

Quick Disconnects, Receptacle, 22 – 20 AWG Wire Size, .32 – .51 mm² Wire Size, 642 – 1021 CMA Wire Size, Mating Tab Width 2.8 mm [.11 in], FASTON 110

[View on TE.com >](#)



Terminals & Splices > Quick Disconnects

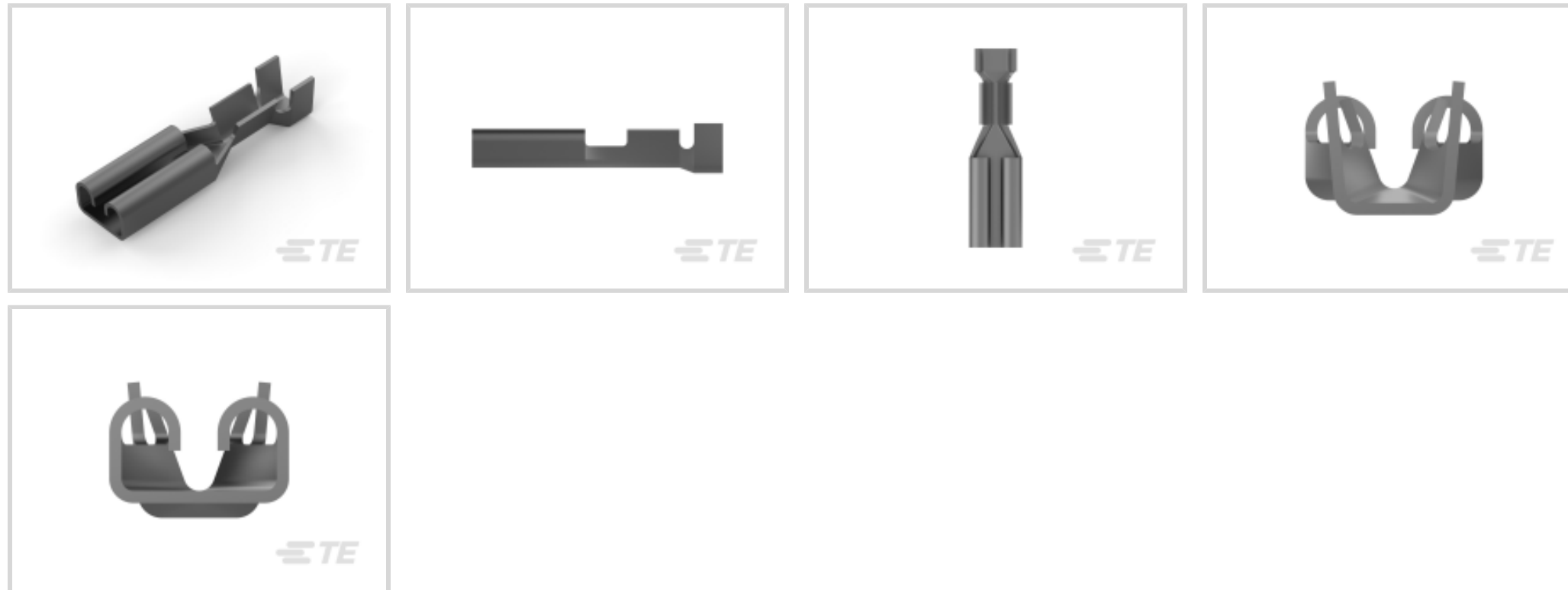

Quick Disconnect Terminal Type: **Receptacle**

Wire Size: **642 – 1021 CMA**

Mating Tab Width: **2.8 mm [.11 in]**

Features

Product Type Features

Insertion Force	Low
-----------------	-----

Configuration Features

Connection Capacity	Single
Compatible With Wire & Cable Type	Discrete Wire

Contact Features

Quick Disconnect Terminal Type	Receptacle
Mating Tab Width	2.8 mm [.11 in]
Mating Tab Thickness	.81 mm [.032 in]
Terminal Orientation	Straight
Contact Base Material	Brass
Terminal Plating Material	Tin
Crimp Type	F-Crimp
Barrel Type	Open

Termination Features

Product Terminates To	Wire & Cable
-----------------------	--------------



Mechanical Attachment

Extraction Force	60 Newton
Wire Insulation Support	With
Mating Retention Type	Dimple

Dimensions

Terminal Material Thickness	.25 mm[.01 in]
Product Length	14 mm[.55 in]
Compatible Insulation Diameter Range	1.3 – 2 mm[.051 – .078 in]
Wire Size	642 – 1021 CMA

Usage Conditions

Insulation Option	Uninsulated
Operating Temperature Range	-40 – 110 °C[-40 – 230 °F]

Industry Standards

Agency/Standard	CSA, UL
-----------------	---------

Packaging Features

Packaging Quantity	500
Packaging Method	Loose Piece/Carton

Other

Terminals & Splices Comment	Chamfered
-----------------------------	-----------

Product Compliance

[For compliance documentation, visit the product page on TE.com>](#)

EU RoHS Directive 2011/65/EU	Compliant
EU ELV Directive 2000/53/EC	Compliant
China RoHS 2 Directive MIIT Order No 32, 2016	No Restricted Materials Above Threshold
EU REACH Regulation (EC) No. 1907/2006	Current ECHA Candidate List: JUNE 2023 (235) Candidate List Declared Against: JUNE 2023 (235) Does not contain REACH SVHC
Halogen Content	Low Halogen - Br, Cl, F, I < 900 ppm per homogenous material. Also BFR/CFR/PVC Free
Solder Process Capability	Not applicable for solder process capability



Product Compliance Disclaimer

This information is provided based on reasonable inquiry of our suppliers and represents our current actual knowledge based on the information they provided. This information is subject to change. The part numbers that TE has identified as EU RoHS compliant have a maximum concentration of 0.1% by weight in homogenous materials for lead, hexavalent chromium, mercury, PBB, PBDE, DBP, BBP, DEHP, DIBP, and 0.01% for cadmium, or qualify for an exemption to these limits as defined in the Annexes of Directive 2011/65/EU (RoHS2). Finished electrical and electronic equipment products will be CE marked as required by Directive 2011/65/EU. Components may not be CE marked. Additionally, the part numbers that TE has identified as EU ELV compliant have a maximum concentration of 0.1% by weight in homogenous materials for lead, hexavalent chromium, and mercury, and 0.01% for cadmium, or qualify for an exemption to these limits as defined in the Annexes of Directive 2000/53/EC (ELV). Regarding the REACH Regulation, the information TE provides on SVHC in articles for this part number is based on the latest European Chemicals Agency (ECHA) 'Guidance on requirements for substances in articles' posted at this URL: <https://echa.europa.eu/guidance-documents/guidance-on-reach>

Compatible Parts



TE Part # 160668-2
110 FASTIN FASTON, REC., 20-16 AWG, PTBR



TE Part # 141628-2
110 FASTON HSG., REC., 1 POS, NATRUAL



TE Part # 141628-4
110 FASTON HSG., REC., 1 POS, BLACK



TE Part # 574868
DAHT TAPER PIN FASTON 24-22 ASSY



TE Part # 734520-1
.110 FAST. HANDTOOL



TE Part # 735052
110 FASTON SLEEVE REC. 1P NATURAL

Also in the Series | FASTON 110

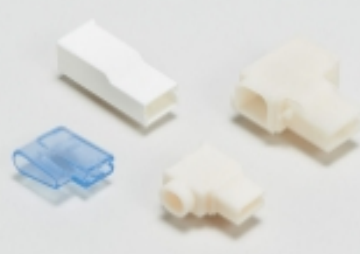

Crimp Terminal Housings(13)



Insertion & Extraction Tools(1)



PCB Terminals(21)

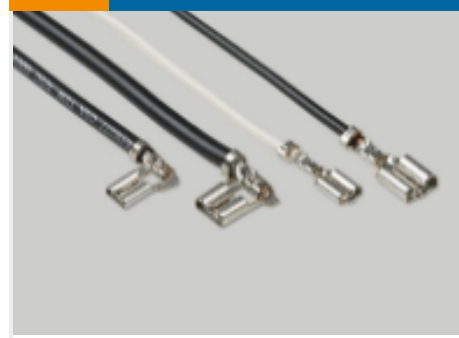

Quick Disconnects(171)

Customers Also Bought

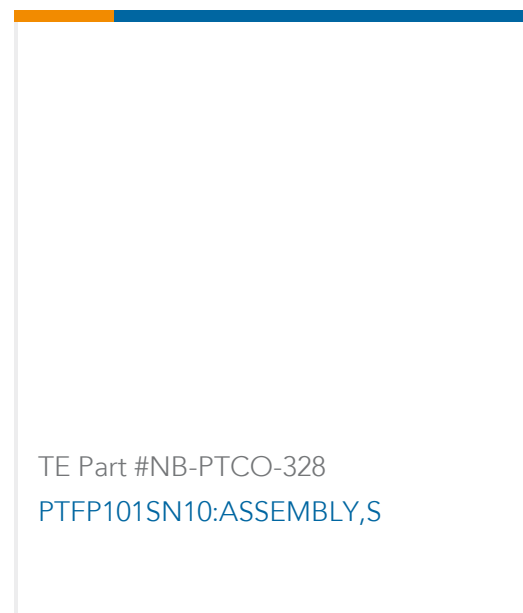
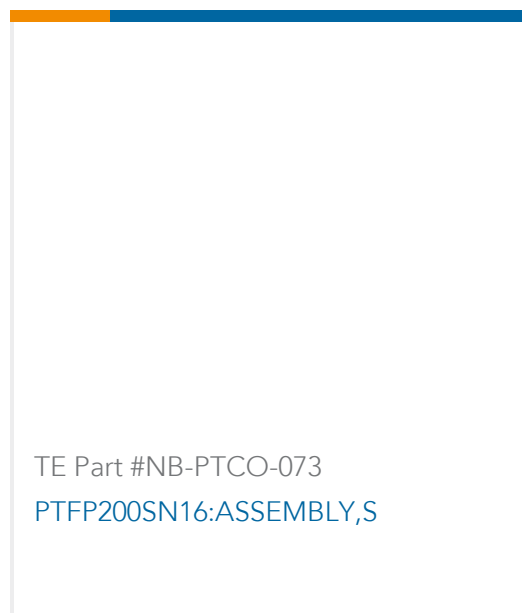
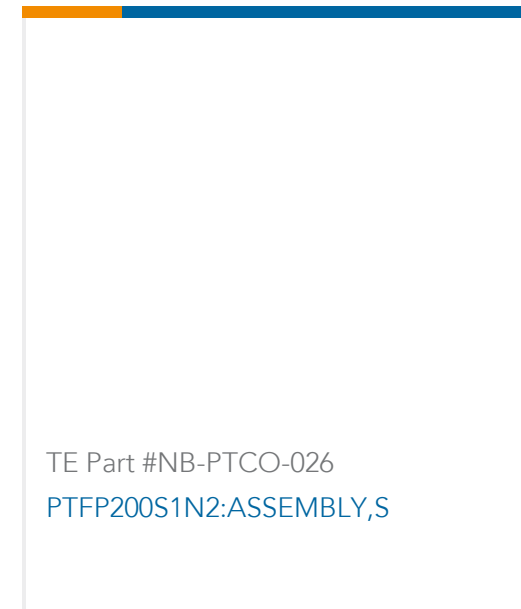
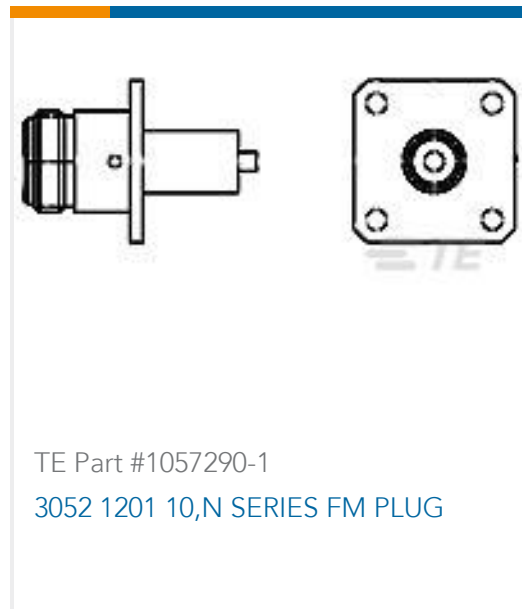
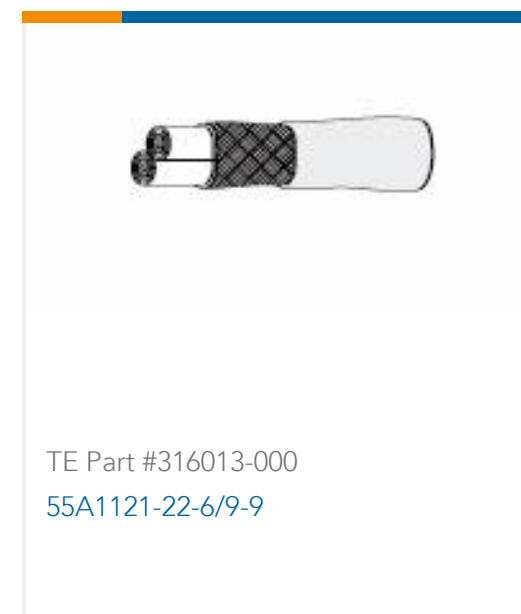

Documents

Product Drawings

[FASTON 110 REC 22-20 AWG ELECTRO TPBR](#)

English

CAD Files

Customer View Model

[ENG_CVM_CVM_5-160321-2_K.2d_dxf.zip](#)

English

3D PDF

3D

Customer View Model

[ENG_CVM_CVM_5-160321-2_K.3d_igs.zip](#)

English

Customer View Model

[ENG_CVM_CVM_5-160321-2_K.3d_stp.zip](#)

English

By downloading the CAD file I accept and agree to the [Terms and Conditions](#) of use.

Product Specifications



Product Specification

English

Product Environmental Compliance

[MD_5-160321-2_112520182252_dmtec](#)

English

[MD_5-160321-2_112520182252_dmtec](#)

English

Agency Approvals

[UL Report](#)

English