

5-104506-6 ✓ ACTIVE

AMPMODU | AMPMODU MTE

TE Internal #: 5-104506-6

Connector Contact, Pin, Wire-to-Board, 32 – 28 AWG Wire Size, 64 – 175 CMA Wire Size, .03 – .09 mm² Wire Size, Gold, Strip, Wire & Cable, AMPMODU MTE

[View on TE.com >](#)



Connectors > PCB Connectors > Wire-to-Board Connectors > Wire-to-Board Connector Contacts

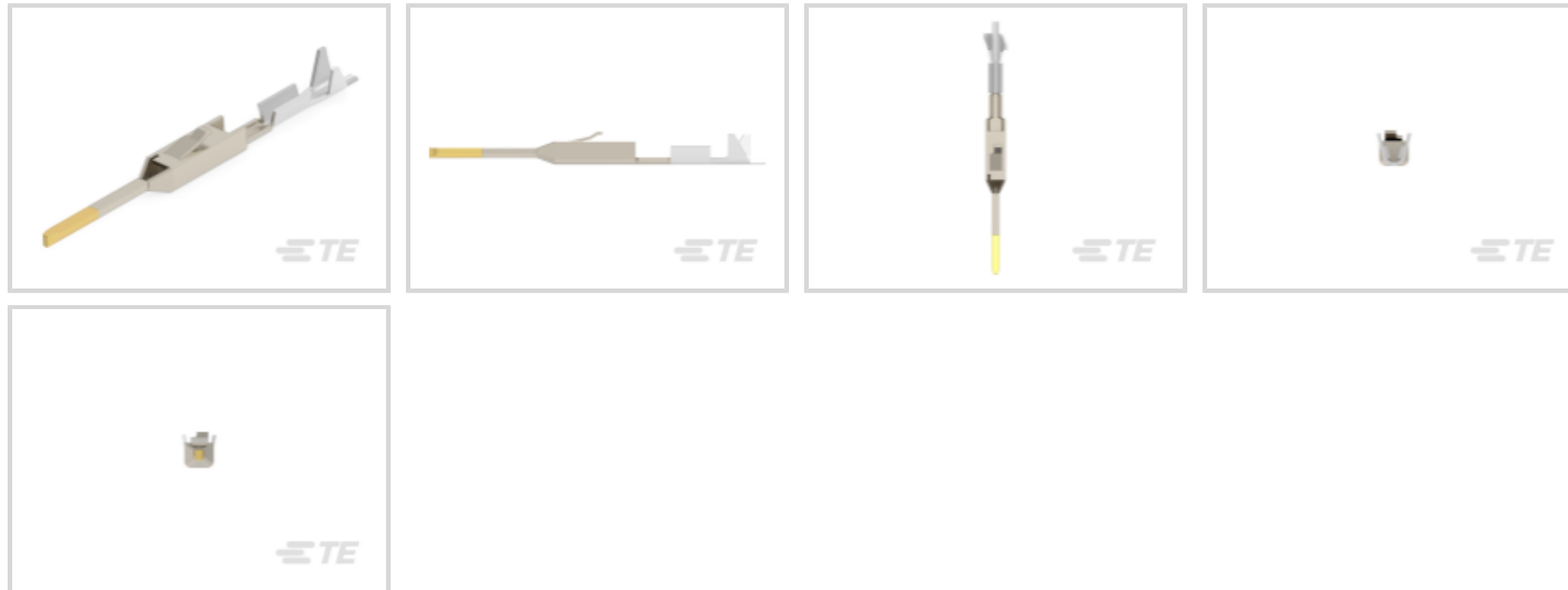

Contact Type: **Pin**

Connector System: **Wire-to-Board**

Wire Size: **.03 – .09 mm²**

Features

Product Type Features

Applied Pressure	Standard
Connector System	Wire-to-Board
Connector & Contact Terminates To	Wire & Cable

Electrical Characteristics

Termination Resistance	12 mΩ
Insulation Resistance	5000 MΩ
Dielectric Withstanding Voltage (Max)	750 V
Operating Voltage	300 VAC

Contact Features

Mating Square Post Dimension	.64 mm[.025 in]
Wire Contact Termination Area Plating Thickness	1.27 – 2.54 μm[50 – 100 μin]
Wire Contact Termination Area Plating Material Finish	Matte
Wire Contact Termination Area Plating Material	Tin
	30 μin
Contact Underplating Material	Nickel



Contact Base Material	Phosphor Bronze
Contact Type	Pin
Contact Mating Area Plating Material	Gold
Contact Current Rating (Max)	3 A

Termination Features

Termination Method to Wire & Cable	Crimp
------------------------------------	-------

Mechanical Attachment

Wire Insulation Support	With
-------------------------	------

Dimensions

Compatible Insulation Diameter Range	.64 – 1.37 mm [.025 – .054 in]
Wire Size	.03 – .09 mm ²

Usage Conditions

Operating Temperature Range	-65 – 105 °C [-85 – 221 °F]
-----------------------------	-----------------------------

Operation/Application

Circuit Application	Signal
---------------------	--------

Industry Standards

Approved Standards	CSA LR7189, UL E28476
--------------------	-----------------------

Packaging Features

Packaging Quantity	12500
Packaging Method	Strip

Product Compliance

[For compliance documentation, visit the product page on TE.com>](#)

EU RoHS Directive 2011/65/EU	Compliant
EU ELV Directive 2000/53/EC	Compliant
China RoHS 2 Directive MIIT Order No 32, 2016	No Restricted Materials Above Threshold
EU REACH Regulation (EC) No. 1907/2006	Current ECHA Candidate List: JUNE 2023 (235) Candidate List Declared Against: JUNE 2023 (235) Does not contain REACH SVHC
Halogen Content	Low Halogen - Br, Cl, F, I < 900 ppm per homogenous material. Also BFR/CFR/PVC Free



Solder Process Capability

Not applicable for solder process capability

Product Compliance Disclaimer

This information is provided based on reasonable inquiry of our suppliers and represents our current actual knowledge based on the information they provided. This information is subject to change. The part numbers that TE has identified as EU RoHS compliant have a maximum concentration of 0.1% by weight in homogenous materials for lead, hexavalent chromium, mercury, PBB, PBDE, DBP, BBP, DEHP, DIBP, and 0.01% for cadmium, or qualify for an exemption to these limits as defined in the Annexes of Directive 2011/65/EU (RoHS2). Finished electrical and electronic equipment products will be CE marked as required by Directive 2011/65/EU. Components may not be CE marked. Additionally, the part numbers that TE has identified as EU ELV compliant have a maximum concentration of 0.1% by weight in homogenous materials for lead, hexavalent chromium, and mercury, and 0.01% for cadmium, or qualify for an exemption to these limits as defined in the Annexes of Directive 2000/53/EC (ELV). Regarding the REACH Regulation, the information TE provides on SVHC in articles for this part number is based on the latest European Chemicals Agency (ECHA) 'Guidance on requirements for substances in articles' posted at this URL: <https://echa.europa.eu/guidance-documents/guidance-on-reach>

Compatible Parts



TE Part # 2305570-1
Strip Terminal Cutter-Side Feed-No Crimp



TE Part # 843477-1
TOOL, EXTRACTION RESET



TE Part # 1901786-1
CCII PIN REC CONT 32-28 ASSY



TE Part # 2151863-1
OCEAN-2.0-APPLICATOR-S-033F055O



TE Part # 2151863-2
OCEAN-2.0-APPLICATOR-S-033F055OA



TE Part # 7-2151863-1
OCEAN-2.0-APPLICATOR-S-033F055O



TE Part # 7-2151863-2
OCEAN-2.0-APPLICATOR-S-033F055OA

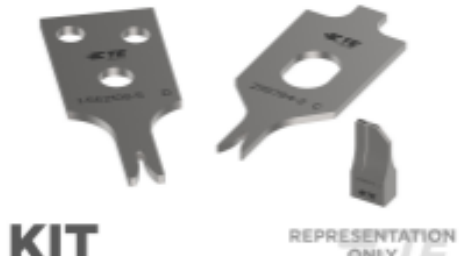

TE Part # 7-2151863-7
OCEAN_2.0_SPARE_PART_KIT-055F090OV



TE Part # 2-2151863-1
OCEAN-2.0-APPLICATOR-S-033F055O

Also in the Series | **AMPMODU MTE**



Connector Caps & Covers(40)

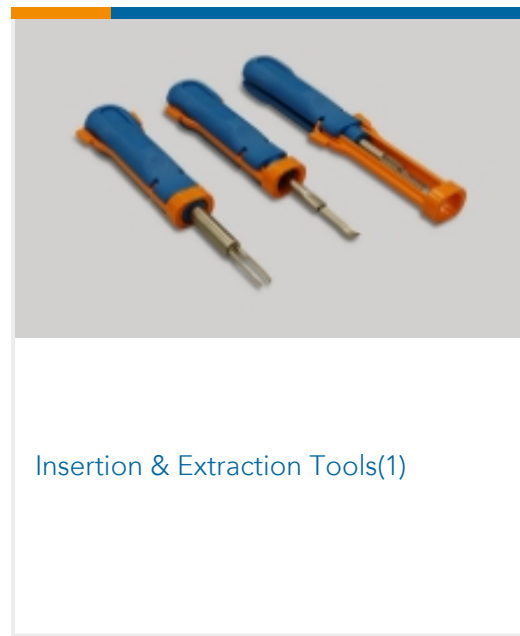

Insertion & Extraction Tools(1)



PCB Headers & Receptacles(763)

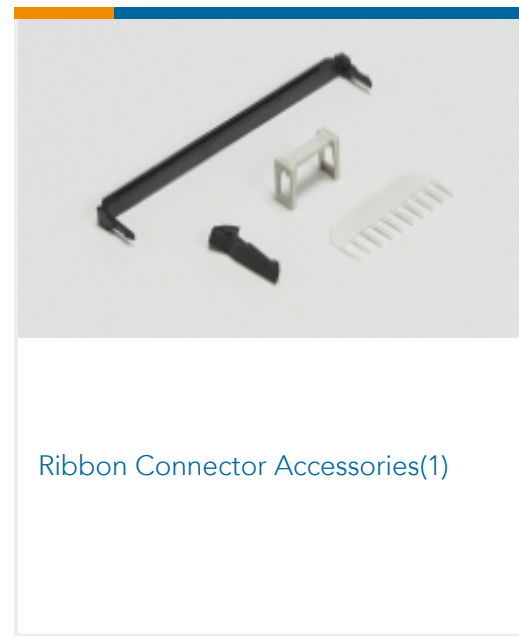

Ribbon Connector Accessories(1)

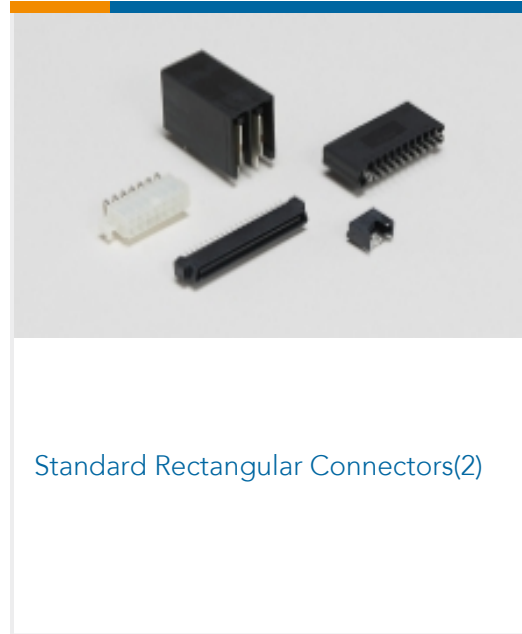

Standard Rectangular Connectors(2)

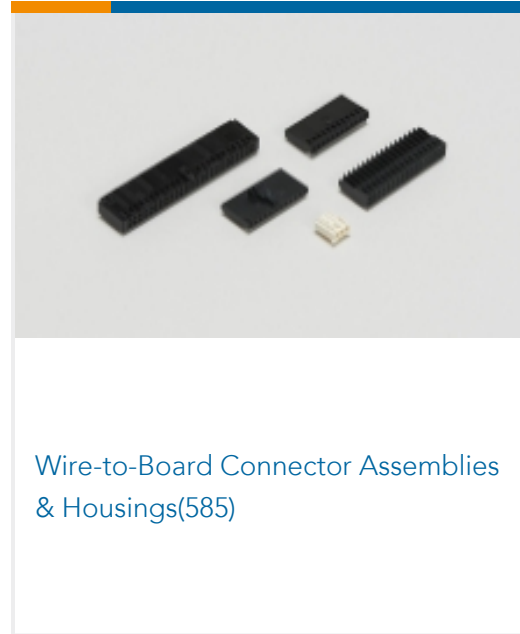

Wire-to-Board Connector Assemblies & Housings(585)

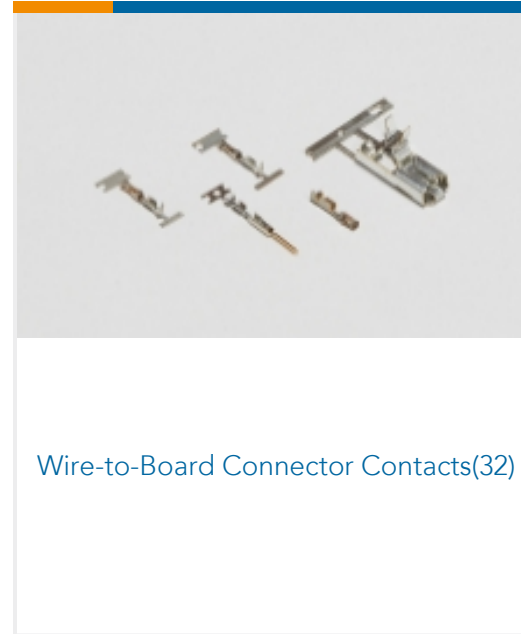

Wire-to-Board Connector Contacts(32)

Customers Also Bought



TE Part #3-643816-8
08P MTA100 CONN ASSY POL RIB



TE Part #3-644042-2
02P MTA100 CONN ASSY LF



TE Part #173977-4
CT CONN MT REC ASSY 4P

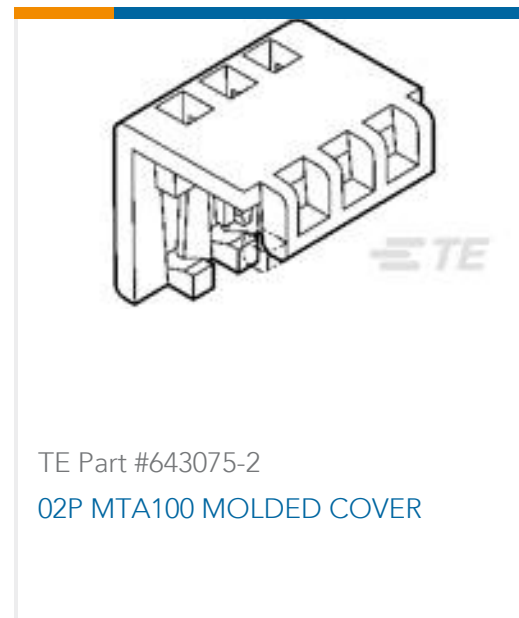

TE Part #643075-2
02P MTA100 MOLDED COVER



TE Part #103653-7
08 MTE SHRD PIN HSG SR LATCH



TE Part #103648-7
08 MTE RCPT HSG SR RIB .100CL



TE Part #5-103961-4
4X5 MTE RCPT SR LATCH .100CL



TE Part #179956-6
DYNAMIC D-5 REC M AG FORM



TE Part #5-103945-3
4X4 MTE SHRD PIN SR LATCH .100



TE Part #5-103958-4
4X5 MTE RCPT SR LATCH .100CL

Documents



Product Drawings

MTE PIN 28-32 AWG PLTD

English

CAD Files

3D PDF

English

Customer View Model

[ENG_CVM_5-104506-6_H.3d_igs.zip](#)

English

Customer View Model

[ENG_CVM_5-104506-6_H.3d_stp.zip](#)

English

Customer View Model

[ENG_CVM_5-104506-6_H.2d_dxf.zip](#)

English

3D PDF

3D

Customer View Model

[ENG_CVM_CVM_5-104506-6_T.2d_dxf.zip](#)

English

Customer View Model

[ENG_CVM_CVM_5-104506-6_T.3d_igs.zip](#)

English

Customer View Model

[ENG_CVM_CVM_5-104506-6_T.3d_stp.zip](#)

English

By downloading the CAD file I accept and agree to the [Terms and Conditions](#) of use.

Datasheets & Catalog Pages

AMPMODU_INTERCONNECTION_SYSTEM_SECTION5_CONT

English

AMPMODU MTE INTERCONNECT SYSTEM

English

Product Specifications

Application Specification

English

Product Environmental Compliance

MD_5-104506-6_040220142357_dmtec

English

MD_5-104506-6_040220142357_dmtec

English