

5-104505-3 ✓ ACTIVE

AMPMODU | AMPMODU MTE

TE Internal #: 5-104505-3

Connector Contact, Pin, Wire-to-Board, 26 – 22 AWG Wire Size,
254 – 642 CMA Wire Size, .12 – .4 mm² Wire Size, Tin, Loose Piece,
AMPMODU MTE

[View on TE.com >](#)



Connectors > PCB Connectors > Wire-to-Board Connectors > Wire-to-Board Connector Contacts

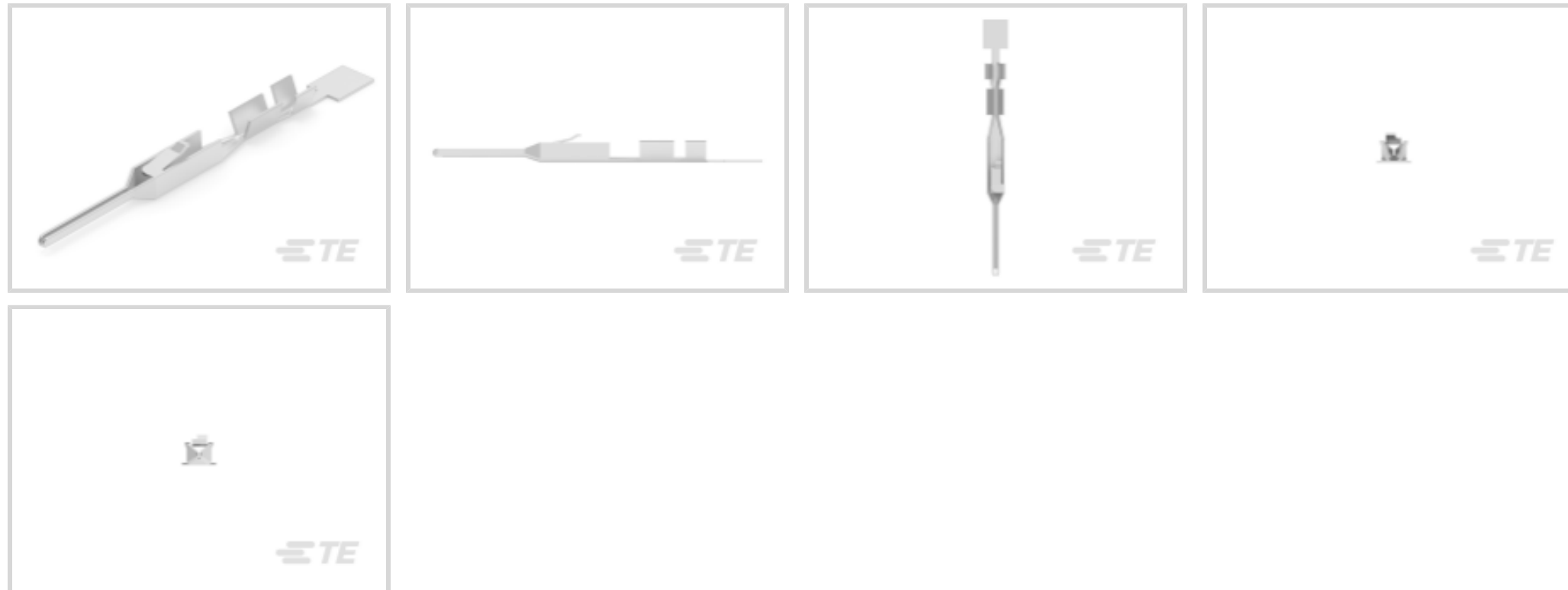

Contact Type: **Pin**

Connector System: **Wire-to-Board**

Wire Size: **.12 – .4 mm²**

Features

Product Type Features

Applied Pressure	Standard
Connector System	Wire-to-Board
Connector & Contact Terminates To	Wire & Cable

Electrical Characteristics

Termination Resistance	12 mΩ
Insulation Resistance	5000 MΩ
Dielectric Withstanding Voltage (Max)	750 V
Operating Voltage	300 VAC

Contact Features

Mating Square Post Dimension	.64 mm[.025 in]
Wire Contact Termination Area Plating Thickness	2.54 – 5.08 μm[100 – 200 μin]
Wire Contact Termination Area Plating Material Finish	Matte
Wire Contact Termination Area Plating Material	Tin
	100 – 200 μin
Contact Underplating Material	Nickel



Contact Base Material	Phosphor Bronze
Contact Type	Pin
Contact Mating Area Plating Material	Tin
Contact Current Rating (Max)	3 A

Termination Features

Termination Method to Wire & Cable	Crimp
------------------------------------	-------

Mechanical Attachment

Wire Insulation Support	With
-------------------------	------

Dimensions

Compatible Insulation Diameter Range	.91 – 1.37 mm [.035 – .054 in]
Wire Size	.12 – .4 mm ²

Usage Conditions

Operating Temperature Range	-65 – 105 °C [-85 – 221 °F]
-----------------------------	-----------------------------

Operation/Application

Circuit Application	Signal
---------------------	--------

Industry Standards

Approved Standards	CSA LR7189, UL E28476
--------------------	-----------------------

Packaging Features

Packaging Quantity	500
Packaging Method	Loose Piece

Product Compliance

[For compliance documentation, visit the product page on TE.com>](#)

EU RoHS Directive 2011/65/EU	Compliant
EU ELV Directive 2000/53/EC	Compliant
China RoHS 2 Directive MIIT Order No 32, 2016	No Restricted Materials Above Threshold
EU REACH Regulation (EC) No. 1907/2006	Current ECHA Candidate List: JUNE 2023 (235) Candidate List Declared Against: JUNE 2023 (235) Does not contain REACH SVHC
Halogen Content	Low Halogen - Br, Cl, F, I < 900 ppm per homogenous material. Also BFR/CFR/PVC Free

Solder Process Capability

Not applicable for solder process capability

Product Compliance Disclaimer

This information is provided based on reasonable inquiry of our suppliers and represents our current actual knowledge based on the information they provided. This information is subject to change. The part numbers that TE has identified as EU RoHS compliant have a maximum concentration of 0.1% by weight in homogenous materials for lead, hexavalent chromium, mercury, PBB, PBDE, DBP, BBP, DEHP, DIBP, and 0.01% for cadmium, or qualify for an exemption to these limits as defined in the Annexes of Directive 2011/65/EU (RoHS2). Finished electrical and electronic equipment products will be CE marked as required by Directive 2011/65/EU. Components may not be CE marked. Additionally, the part numbers that TE has identified as EU ELV compliant have a maximum concentration of 0.1% by weight in homogenous materials for lead, hexavalent chromium, and mercury, and 0.01% for cadmium, or qualify for an exemption to these limits as defined in the Annexes of Directive 2000/53/EC (ELV). Regarding the REACH Regulation, the information TE provides on SVHC in articles for this part number is based on the latest European Chemicals Agency (ECHA) 'Guidance on requirements for substances in articles' posted at this URL: <https://echa.europa.eu/guidance-documents/guidance-on-reach>

Compatible Parts



Also in the Series | AMPMODU MTE

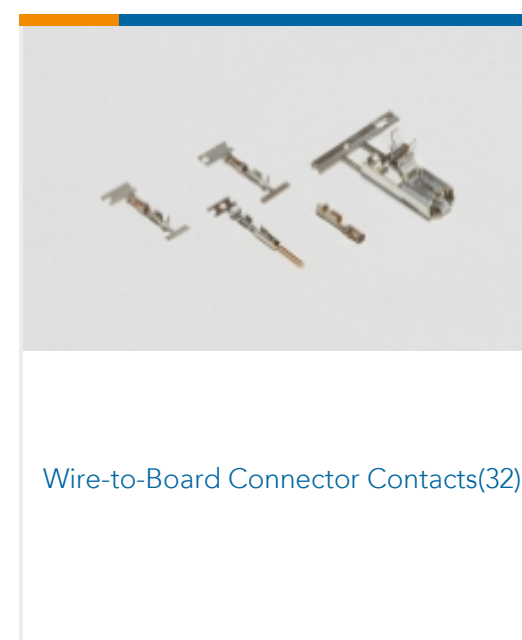
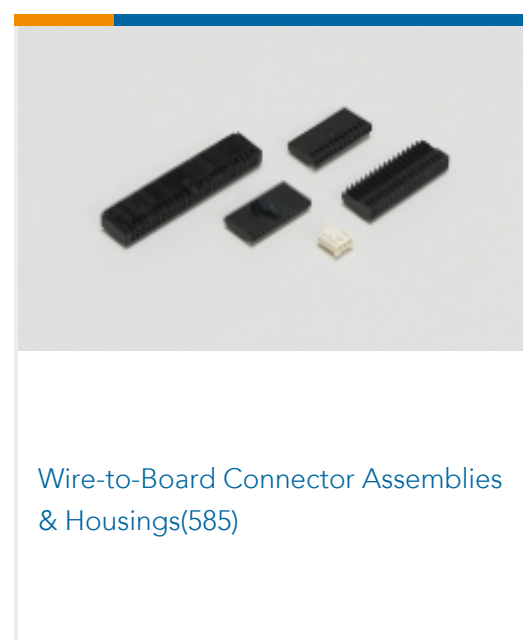
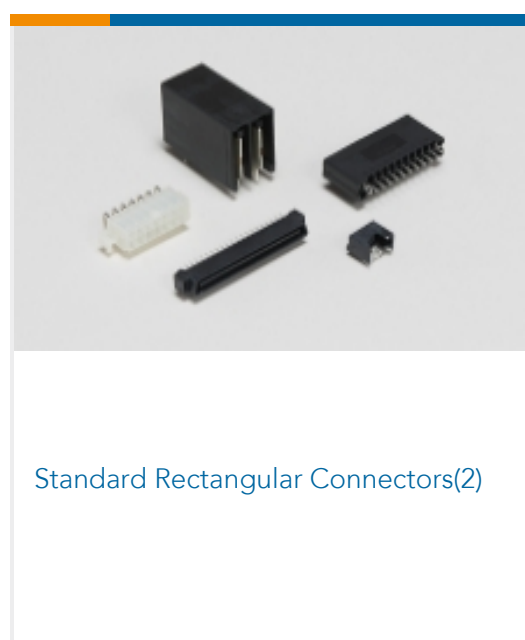
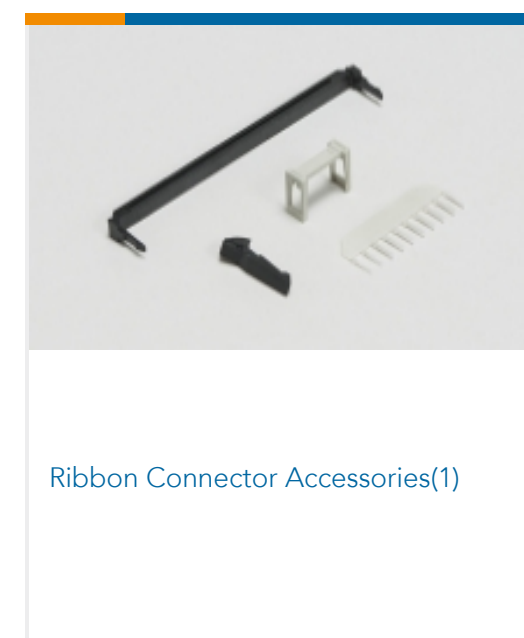
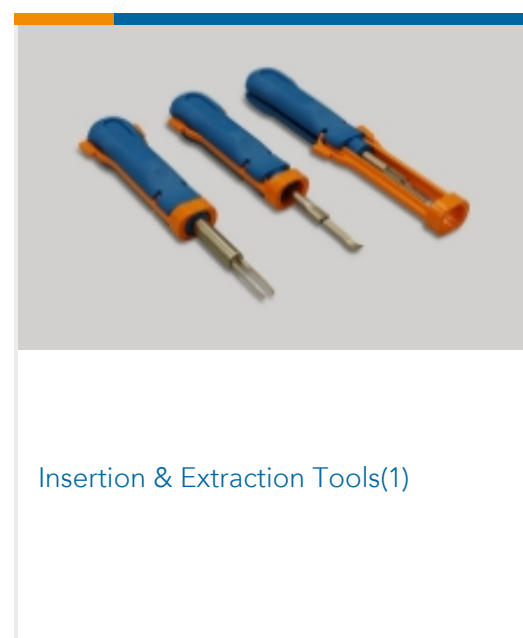
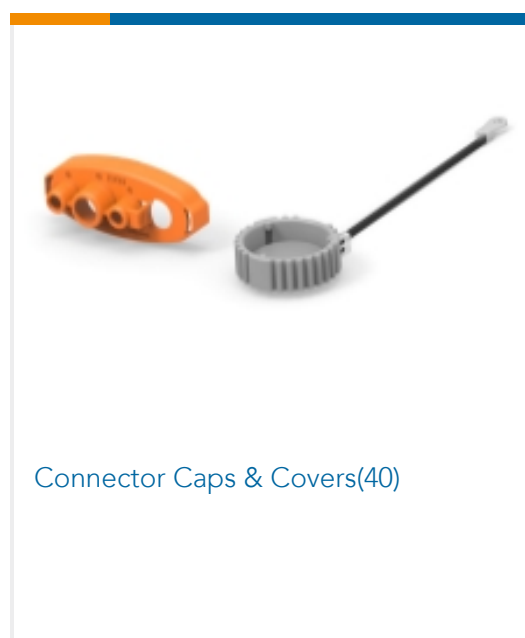

Customers Also Bought



TE Part #103653-4
05 MTE SHRD PIN HSG SR LATCH



TE Part #104257-2
03 MTE RCPT HSG SR LATCH .100



TE Part #104257-3
04 MTE RCPT HSG SR LATCH .100



TE Part #103653-2
03 MTE SHRD PIN HSG SR LATCH



TE Part #5650405-5
ASSEMBLY, RECEPTACLE, EUROCARD,
T



TE Part #5650911-5
ASSY, PIN, EUROCARD, TYPE R, LEAD-
FREE, 150 P



TE Part #1-2176304-8
RP 1E 0.1W 15R 0.1% 25PPM 5K RL



TE Part #1-640250-7
17P SL156 HSG W/LCK RAMP NATL

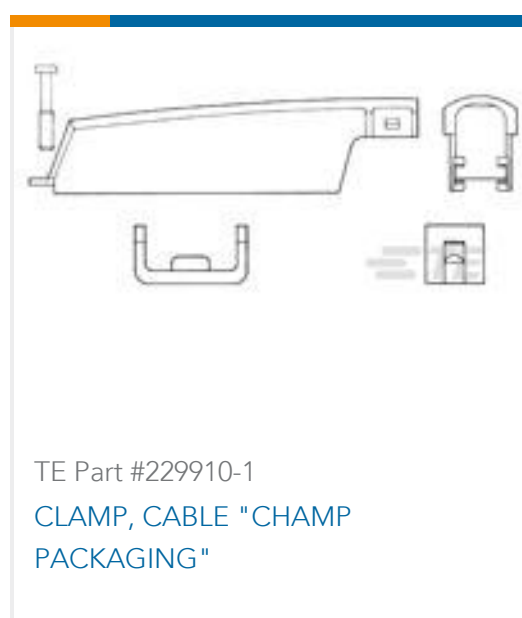

TE Part #229910-1
CLAMP, CABLE "CHAMP
PACKAGING"

Documents

Product Drawings

MTE PIN LP

English

CAD Files

Customer View Model

[ENG_CVM_CVM_5-104505-3_V.2d_dxf.zip](#)

English

3D PDF

3D

Customer View Model

[ENG_CVM_CVM_5-104505-3_V.3d_igs.zip](#)

English

Customer View Model

[ENG_CVM_CVM_5-104505-3_V.3d_stp.zip](#)

English

By downloading the CAD file I accept and agree to the [Terms and Conditions](#) of use.

Datasheets & Catalog Pages



[AMPMODU_INTERCONNECTION_SYSTEM_SECTION5_CONT](#)

English

[AMPMODU MTE INTERCONNECT SYSTEM](#)

English

[Product Specifications](#)

[Application Specification](#)

English

[Product Environmental Compliance](#)

[TE Material Declaration](#)

English