

5-103957-3 ✓ ACTIVE

AMPMODU | AMPMODU MTE

TE Internal #: 5-103957-3

Connector Assembly, Receptacle, Wire-to-Board, 4 Position, .1 in [2.54 mm] Centerline, Crimp / Insulation Displacement (IDC), 1 Row, AMPMODU MTE

[View on TE.com >](#)



Connectors > PCB Connectors > Wire-to-Board Connectors > Wire-to-Board Connector Assemblies & Housings

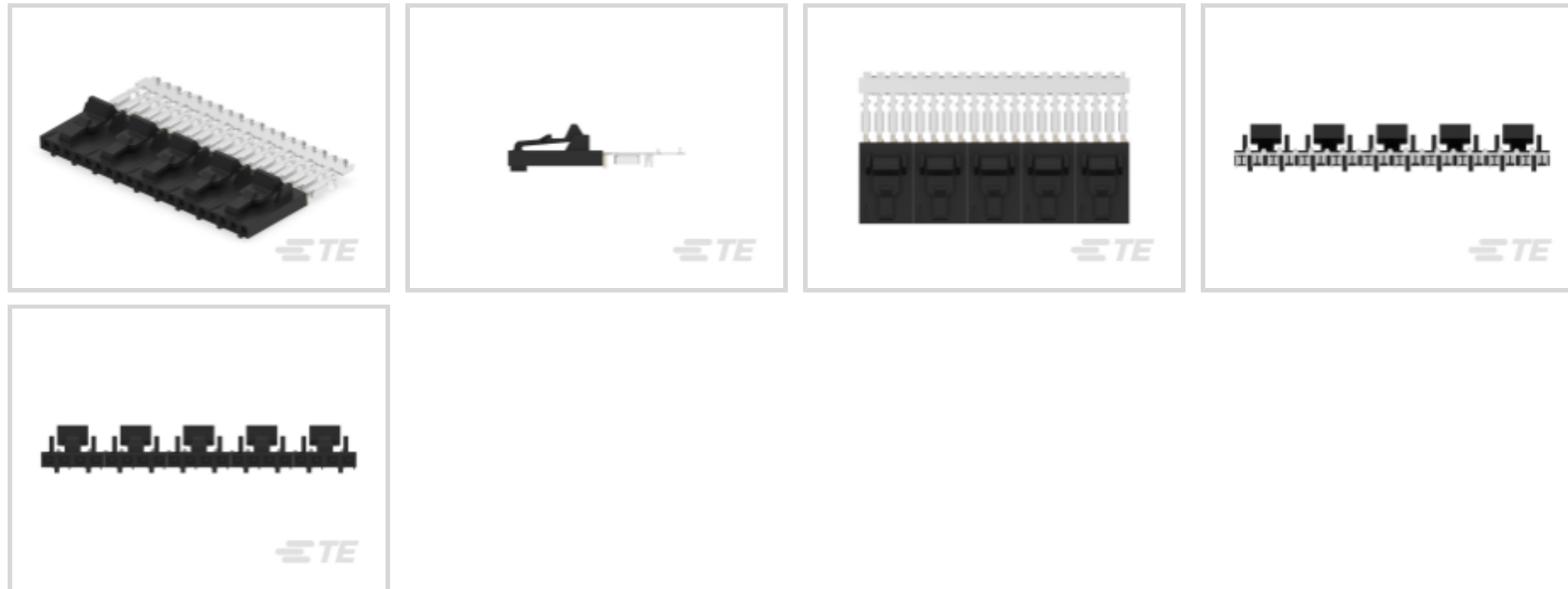

Connector Product Type: **Connector Assembly**

Connector & Housing Type: **Receptacle**

Connector System: **Wire-to-Board**

Number of Positions: **4**

Centerline (Pitch): **2.54 mm [.1 in]**

## Features

### Product Type Features

Applied Pressure	Standard
Connector Product Type	Connector Assembly
Connector & Housing Type	Receptacle
Connector System	Wire-to-Board
Sealable	No
Connector & Contact Terminates To	Wire & Cable

### Configuration Features

Number of Positions	4
Number of Rows	1

### Electrical Characteristics

Termination Resistance	15 mΩ
Dielectric Withstanding Voltage (Max)	600 VAC
Insulation Resistance	5000 MΩ
Operating Voltage	267 V



### Body Features

Primary Product Color	Black
-----------------------	-------

### Contact Features

Contact Retention Within Housing	With
Contact Layout	Inline
Contact Type	Socket
PCB Contact Termination Area Plating Material Finish	Matte
PCB Contact Termination Area Plating Material	Tin
Contact Base Material	Phosphor Bronze
Contact Current Rating (Max)	3 A

### Termination Features

Termination Method to Wire & Cable	Crimp, Insulation Displacement (IDC)
------------------------------------	--------------------------------------

### Mechanical Attachment

Strain Relief	Without
Contact Retention Type Within Housing	Locking Lance
Panel Mount Feature	Without
PCB Mount Retention	Without
Mating Retention Type	Latch
Mating Retention	With
Connector Mounting Type	Cable Mount (Free-Hanging)

### Housing Features

Housing Material	Thermoplastic
Centerline (Pitch)	2.54 mm[.1 in]

### Dimensions

Connector Length	50.55 mm[1.99 in]
Connector Height	6.73 mm[.265 in]
Compatible Insulation Diameter Range	1.37 mm[.054 in]
Wire Size	.12 – .4 mm <sup>2</sup>

### Usage Conditions

Operating Temperature Range	-65 – 105 °C[-85 – 221 °F]
-----------------------------	----------------------------

### Operation/Application

Circuit Application	Signal
---------------------	--------



### Industry Standards

Glow Wire Rating	Standard Part - Not Glow Wire
Approved Standards	CSA LR7189, UL E28476
UL Flammability Rating	UL 94V-0

### Packaging Features

Packaging Quantity	55
Packaging Method	Tube

### Other

Discrete Wire Connector Comment	Maximum insulation diameter is 1.14 [.045] for Pneumatic Terminators., Ribbon Cable Notched handles 22-28 AWG
---------------------------------	---

### Product Compliance

[For compliance documentation, visit the product page on TE.com>](#)

EU RoHS Directive 2011/65/EU	Compliant
EU ELV Directive 2000/53/EC	Compliant
China RoHS 2 Directive MIIT Order No 32, 2016	No Restricted Materials Above Threshold
EU REACH Regulation (EC) No. 1907/2006	Current ECHA Candidate List: JUNE 2023 (235) Candidate List Declared Against: JUNE 2023 (235) Does not contain REACH SVHC
Halogen Content	Not Low Halogen - contains Br or Cl > 900 ppm.
Solder Process Capability	Not applicable for solder process capability

#### Product Compliance Disclaimer

This information is provided based on reasonable inquiry of our suppliers and represents our current actual knowledge based on the information they provided. This information is subject to change. The part numbers that TE has identified as EU RoHS compliant have a maximum concentration of 0.1% by weight in homogenous materials for lead, hexavalent chromium, mercury, PBB, PBDE, DBP, BBP, DEHP, DIBP, and 0.01% for cadmium, or qualify for an exemption to these limits as defined in the Annexes of Directive 2011/65/EU (RoHS2). Finished electrical and electronic equipment products will be CE marked as required by Directive 2011/65/EU. Components may not be CE marked. Additionally, the part numbers that TE has identified as EU ELV compliant have a maximum concentration of 0.1% by weight in homogenous materials for lead, hexavalent chromium, and mercury, and 0.01% for cadmium, or qualify for an exemption to these limits as defined in the Annexes of Directive 2000/53/EC (ELV). Regarding the REACH Regulation, the information TE provides on SVHC in articles for this part number is based on the latest European Chemicals Agency (ECHA) 'Guidance on requirements for substances in articles' posted at this URL: <https://echa.europa.eu/guidance-documents/guidance-on-reach>

### Compatible Parts



Also in the Series | **AMPMODU MTE**

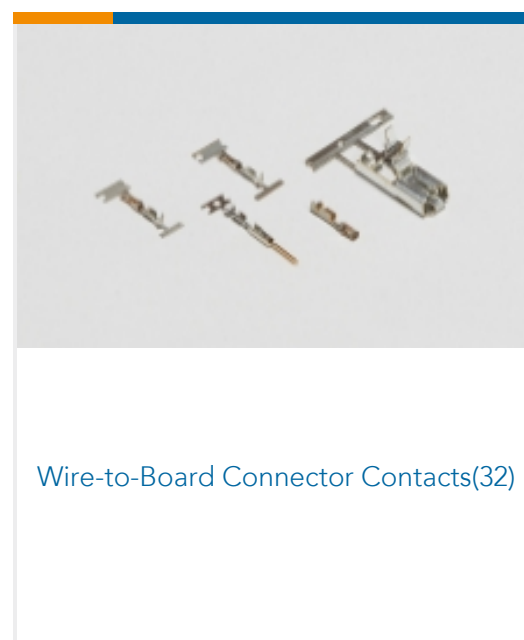
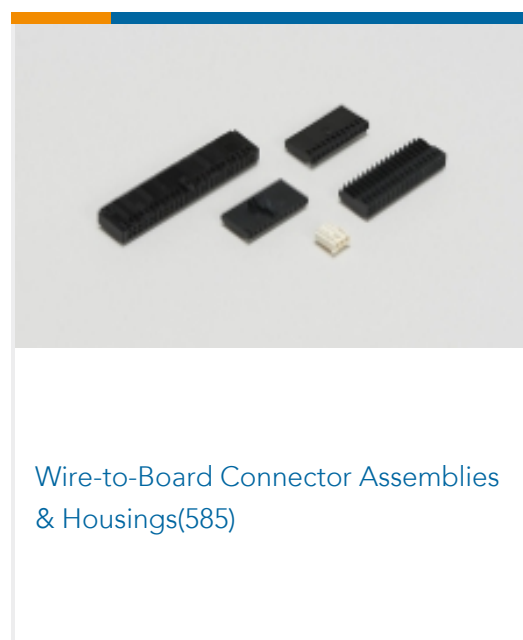
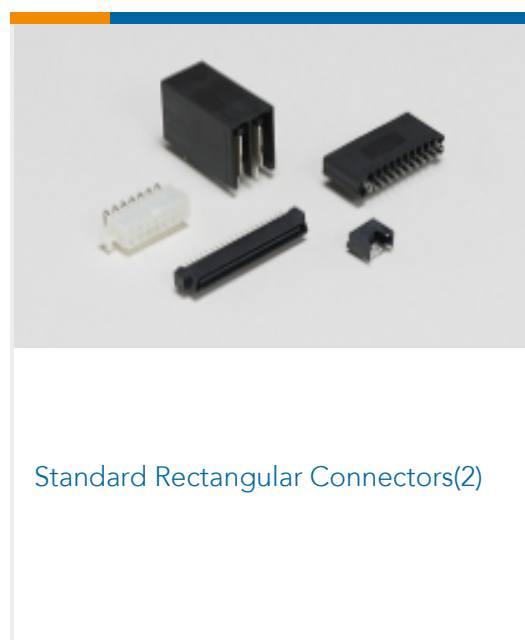
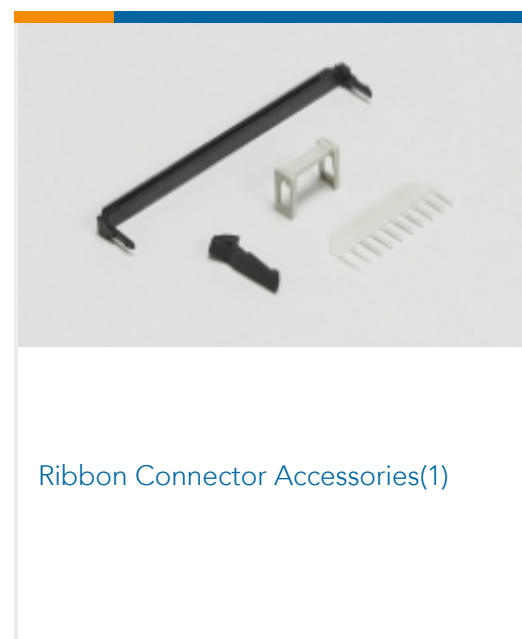
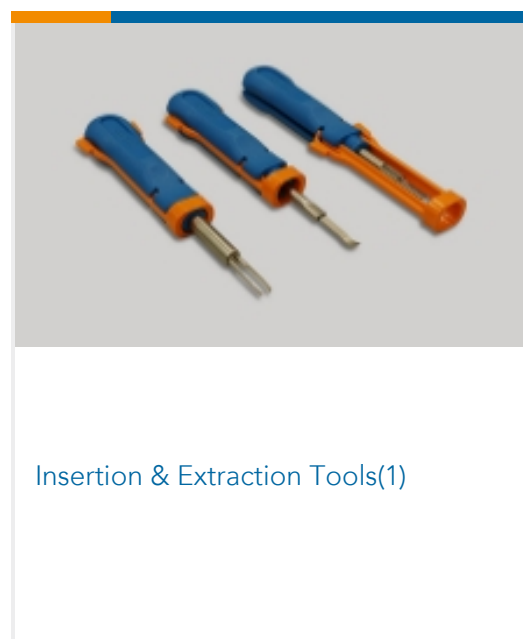
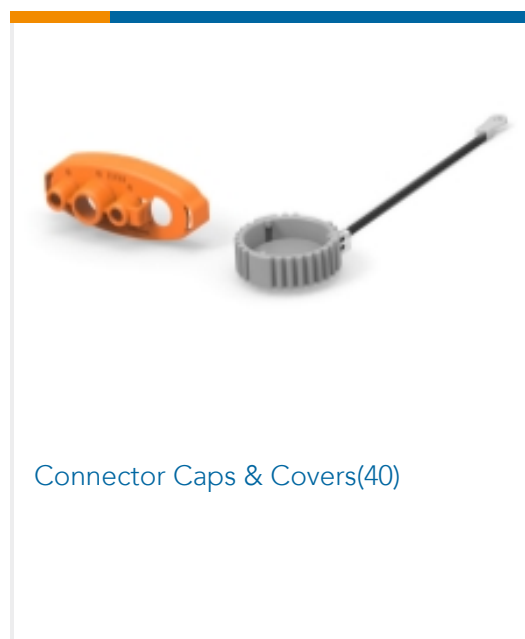

Customers Also Bought





TE Part #6609056-1  
3MV1=F7756 S0



TE Part #1617037-7  
HFW5A1201G00 = HFW 5AMP RELAY



TE Part #5-103946-3  
4X4 MTE SHRD PIN SR POL .100CL

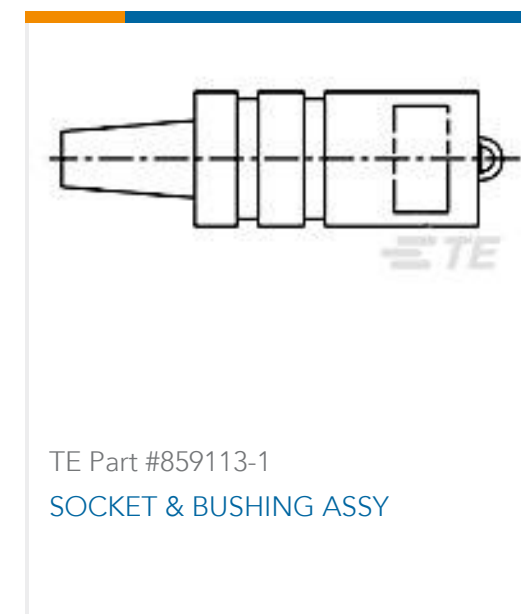

TE Part #859113-1  
SOCKET & BUSHING ASSY



TE Part #1617086-6  
3SBM1071A2 = M39016/31-003M



TE Part #EM7489-000  
X2-8.0-0-FSP-SM



TE Part #5-103957-5  
4X6 MTE RCPT SR LATCH .100CL



TE Part #5-103957-4  
4X5 MTE RCPT SR LATCH .100CL



TE Part #1-2176377-5  
RQ 0805 187K 0.1% 10PPM 1K RL

## Documents

### Product Drawings

[5X4 MTE RCPT SR LATCH .100CL](#)

English

### CAD Files

[3D PDF](#)

English

**Customer View Model**

[ENG\\_CVM\\_5-103957-3\\_N.2d\\_dxf.zip](#)

English

**Customer View Model**

[ENG\\_CVM\\_5-103957-3\\_N.3d\\_igs.zip](#)

English

**Customer View Model**

[ENG\\_CVM\\_5-103957-3\\_N.3d\\_stp.zip](#)

English

[3D PDF](#)

3D



**Customer View Model**

[ENG\\_CVM\\_CVM\\_5-103957-3\\_P.2d\\_dxf.zip](#)

English

**Customer View Model**

[ENG\\_CVM\\_CVM\\_5-103957-3\\_P.3d\\_igs.zip](#)

English

**Customer View Model**

[ENG\\_CVM\\_CVM\\_5-103957-3\\_P.3d\\_stp.zip](#)

English

By downloading the CAD file I accept and agree to the [Terms and Conditions](#) of use.

---

**Datasheets & Catalog Pages**

[AMP MODU MTE Section of Catalog 1307819](#)

English

[AMPMODU\\_INTERCONNECTION\\_SYSTEM\\_SECTION5\\_CONT](#)

English

[AMPMODU MTE INTERCONNECT SYSTEM](#)

English

---

**Product Specifications**

[Application Specification](#)

English

---

**Product Environmental Compliance**

[Product Compliance Document](#)

English

[Product Compliance Document](#)

English