

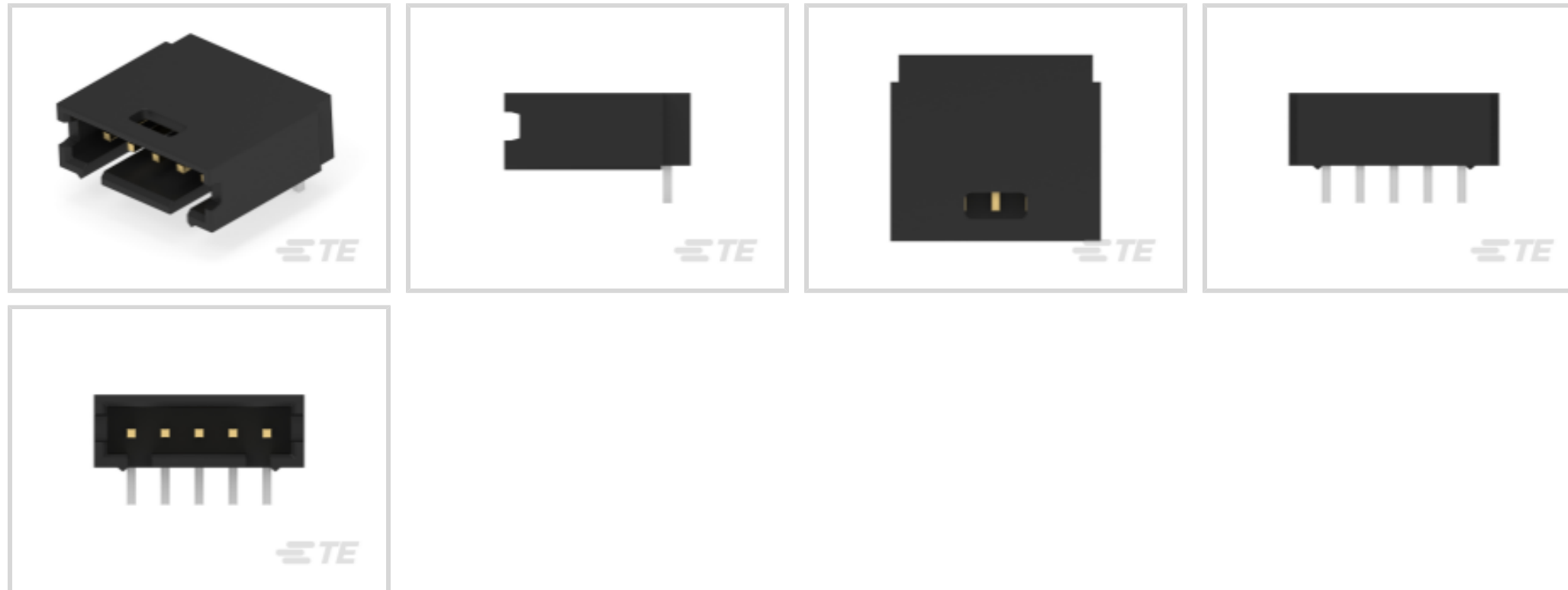

Connectors > PCB Connectors > PCB Headers & Receptacles



PCB Connector Assembly Type: **PCB Mount Header**

PCB Mount Orientation: **Right Angle**

Connector System: **Board-to-Board**

Number of Positions: **5**

Number of Rows: **1**

Features

Product Type Features

PCB Connector Assembly Type	PCB Mount Header
Connector System	Board-to-Board
Header Type	Fully Shrouded
Connector & Contact Terminates To	Printed Circuit Board

Configuration Features

Connector Contact Load Condition	Fully Loaded
PCB Mount Orientation	Right Angle
Number of Positions	5
Number of Rows	1

Electrical Characteristics

Insulation Resistance	5000 MΩ
Dielectric Withstanding Voltage (Max)	750 Vrms

Body Features

Connector Profile	Standard
-------------------	----------



Primary Product Color	Black
-----------------------	-------

Contact Features

Mating Square Post Dimension	.64 mm[.025 in]
PCB Contact Termination Area Plating Material Thickness	2.54 – 5.08 μm [100 – 200 μin]
PCB Contact Termination Area Plating Material Finish	Matte
Contact Shape & Form	Square
Contact Underplating Material	Nickel
PCB Contact Termination Area Plating Material	Tin
Contact Base Material	Phosphor Bronze
Contact Mating Area Plating Material	Gold
Contact Mating Area Plating Material Thickness	.381 μm [15 μin]
Contact Type	Pin
Contact Current Rating (Max)	3 A

Termination Features

Square Termination Post & Tail Dimension	.64 mm[.025 in]
Termination Post & Tail Length	2.79 mm[.11 in]
Termination Method to Printed Circuit Board	Through Hole - Solder

Mechanical Attachment

Mating Alignment	With
Mating Alignment Type	Polarization
PCB Mount Retention	Without
PCB Mount Alignment	Without
Connector Mounting Type	Board Mount

Housing Features

Centerline (Pitch)	2.54 mm[.1 in]
Housing Material	Thermoplastic

Dimensions

Row-to-Row Spacing	2.54 mm[.1 in]
PCB Thickness (Recommended)	1.4 mm[.055 in]

Usage Conditions

Housing Temperature Rating	Standard
Operating Temperature Range	-65 – 105 $^{\circ}\text{C}$ [-85 – 221 $^{\circ}\text{F}$]



Operation/Application

Solder Process Feature	Board Standoff
Circuit Application	Signal

Industry Standards

Agency/Standard	CSA
Approved Standards	CSA LR7189, UL E28476
UL Flammability Rating	UL 94V-0

Packaging Features

Packaging Quantity	34
Packaging Type	Tube

Product Compliance

[For compliance documentation, visit the product page on TE.com>](#)

EU RoHS Directive 2011/65/EU	Compliant
EU ELV Directive 2000/53/EC	Compliant
China RoHS 2 Directive MIIT Order No 32, 2016	No Restricted Materials Above Threshold
EU REACH Regulation (EC) No. 1907/2006	Current ECHA Candidate List: JUNE 2023 (235) Candidate List Declared Against: JUNE 2023 (235) Does not contain REACH SVHC
Halogen Content	BFR/CFR/PVC Free, but Br/Cl >900 ppm in other sources.
Solder Process Capability	Wave solder capable to 240°C

Product Compliance Disclaimer

This information is provided based on reasonable inquiry of our suppliers and represents our current actual knowledge based on the information they provided. This information is subject to change. The part numbers that TE has identified as EU RoHS compliant have a maximum concentration of 0.1% by weight in homogenous materials for lead, hexavalent chromium, mercury, PBB, PBDE, DBP, BBP, DEHP, DIBP, and 0.01% for cadmium, or qualify for an exemption to these limits as defined in the Annexes of Directive 2011/65/EU (RoHS2). Finished electrical and electronic equipment products will be CE marked as required by Directive 2011/65/EU. Components may not be CE marked. Additionally, the part numbers that TE has identified as EU ELV compliant have a maximum concentration of 0.1% by weight in homogenous materials for lead, hexavalent chromium, and mercury, and 0.01% for cadmium, or qualify for an exemption to these limits as defined in the Annexes of Directive 2000/53/EC (ELV). Regarding the REACH Regulation, the information TE provides on SVHC in articles for this part number is based on the latest European Chemicals Agency (ECHA) 'Guidance on requirements for substances in articles' posted at this URL: <https://echa.europa.eu/guidance-documents/guidance-on-reach>

Compatible Parts



Also in the Series | AMPMODU Headers

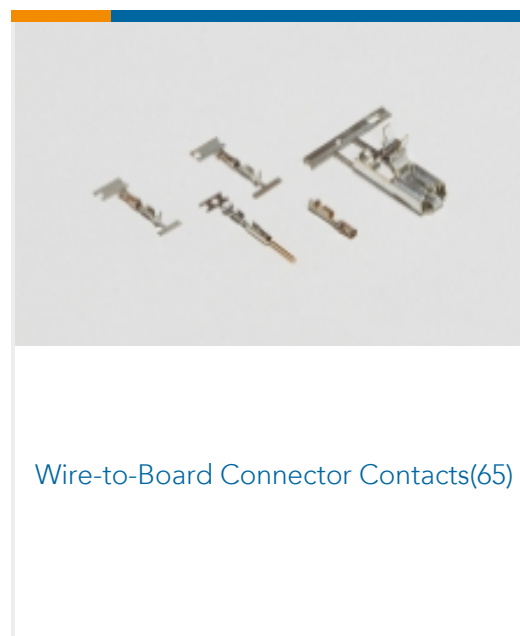
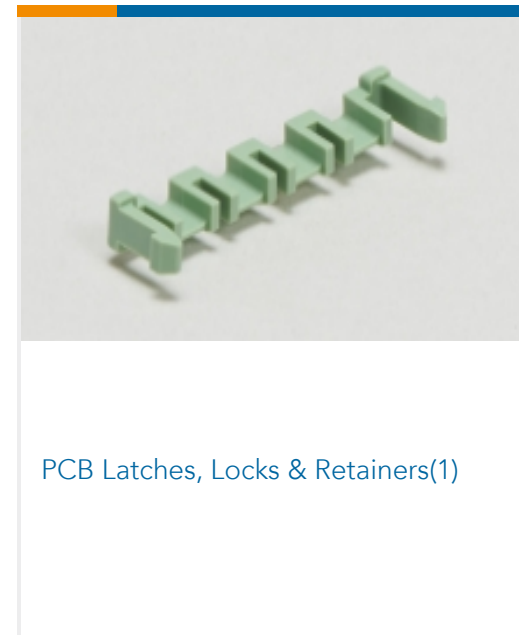

Customers Also Bought

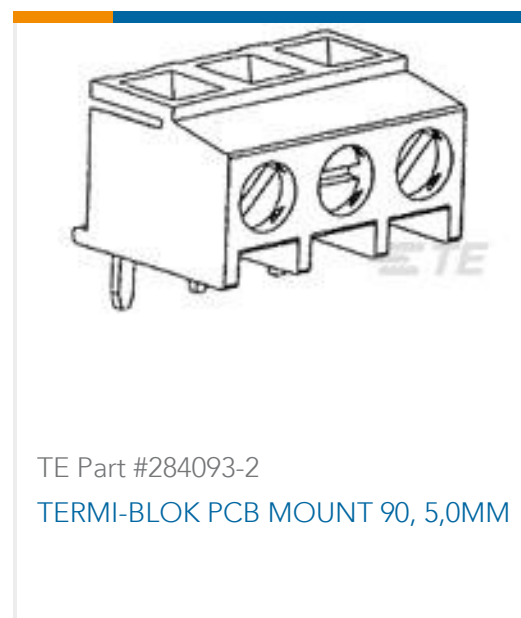



Documents

Product Drawings

[05 MODII HDR SRRA SHRD LF](#)

English

CAD Files

[3D PDF](#)

English

[Customer View Model](#)

[ENG_CVM_5-102203-2_V.3d_igs.zip](#)

English

[Customer View Model](#)

[ENG_CVM_5-102203-2_V.3d_stp.zip](#)

English

[Customer View Model](#)

[ENG_CVM_5-102203-2_V.2d_dxf.zip](#)

English

By downloading the CAD file I accept and agree to the [Terms and Conditions](#) of use.

Datasheets & Catalog Pages

[AMPMODU_INTERCONNECTION_SYSTEM_SECTION5](#)

English

[AMPMODU Interconnetion System](#)

[AMPMODU Interconnetion System](#)

English

Product Environmental Compliance

[TE Material Declaration](#)

English