

48752-1 ✓ ACTIVE

AMP

TE Internal #: 48752-1

Hand Crimping Tools, Premium Crimp Tooling, Removable /Interchangeable, MIL Spec / TE Product Specification (114-), Hydraulic / Manual / Battery

[View on TE.com >](#)



Application Tooling > Hand Crimping Tools



Tool Grade: **Premium Crimp Tooling**

Die Sets Type: **Removable/Interchangeable**

Specification Type: **MIL Spec, TE Product Specification (114-)**

TE Certification: **Yes – Certificate Included**

Power Technology Type: **Battery, Hydraulic, Manual**

Features

Other

Crimp Form-Wire Barrel Type	Closed Barrel - Confined Crescent
Tool Grade	Premium Crimp Tooling
Die Sets Type	Removable/Interchangeable
Specification Type	MIL Spec, TE Product Specification (114-)
TE Certification	Yes – Certificate Included
Power Technology Type	Battery, Hydraulic, Manual
Tooling Type	Die Assembly

Product Compliance

[For compliance documentation, visit the product page on TE.com>](#)

EU RoHS Directive 2011/65/EU	Compliant
EU ELV Directive 2000/53/EC	Out of Scope
China RoHS 2 Directive MIIT Order No 32, 2016	No Restricted Materials Above Threshold
EU REACH Regulation (EC) No. 1907/2006	Current ECHA Candidate List: JAN 2023 (233) Candidate List Declared Against: JAN 2021 (211) Does not contain REACH SVHC
Halogen Content	Low Halogen - Br, Cl, F, I < 900 ppm per homogenous material. Also BFR/CFR/PVC

Free













Solder Process Capability

Not reviewed for solder process capability

Product Compliance Disclaimer

This information is provided based on reasonable inquiry of our suppliers and represents our current actual knowledge based on the information they provided. This information is subject to change. The part numbers that TE has identified as EU RoHS compliant have a maximum concentration of 0.1% by weight in homogenous materials for lead, hexavalent chromium, mercury, PBB, PBDE, DBP, BBP, DEHP, DIBP, and 0.01% for cadmium, or qualify for an exemption to these limits as defined in the Annexes of Directive 2011/65/EU (RoHS2). Finished electrical and electronic equipment products will be CE marked as required by Directive 2011/65/EU. Components may not be CE marked. Additionally, the part numbers that TE has identified as EU ELV compliant have a maximum concentration of 0.1% by weight in homogenous materials for lead, hexavalent chromium, and mercury, and 0.01% for cadmium, or qualify for an exemption to these limits as defined in the Annexes of Directive 2000/53/EC (ELV). Regarding the REACH Regulation, the information TE provides on SVHC in articles for this part number is based on the latest European Chemicals Agency (ECHA) 'Guidance on requirements for substances in articles' posted at this URL: <https://echa.europa.eu/guidance-documents/guidance-on-reach>

Compatible Parts

 <p>TE Part # 52291-1 TERMINAL R PG 8 3/8</p>	 <p>TE Part # 52041-1 TERMINAL,R PG 8 1/4</p>	 <p>TE Part # 52041-3 TERMINAL,R PG 8 1/4</p>	 <p>TE Part # 52291 TERMINAL R PG 8 5/16</p>
 <p>TE Part # 52263-1 TERMINAL R PG 8 10</p>	 <p>TE Part # 52262-1 TERMINAL R PG 8 1/2</p>	 <p>TE Part # 55621-1 TERMINAL R PG 8 1/4</p>	 <p>TE Part # 52263-5 TERMINAL R PG 8 10</p>
 <p>TE Part # 53943-1 TERMINAL,R PVF2 PG 8 1/4</p>	 <p>TE Part # 53978-1 TERMINAL,R PVF2 PG 8 10</p>	 <p>TE Part # 59974-1 HYP8 8-2AWG MANUAL TOOL-No Dies</p>	 <p>TE Part # 69051 HYP8 8-2AWG 8T HEAD</p>



Customers Also Bought

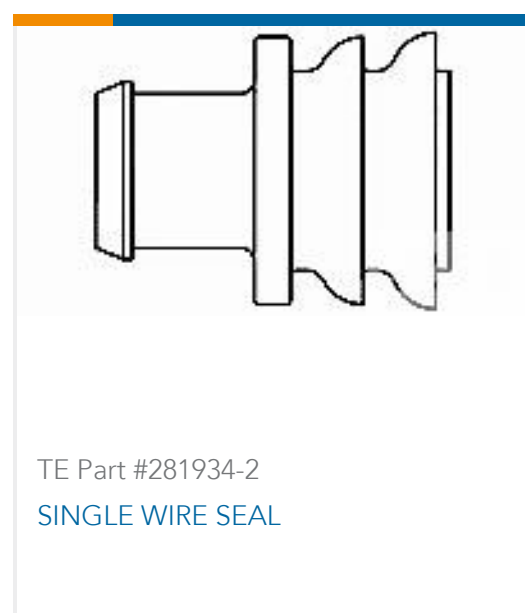

Documents

Datasheets & Catalog Pages

[AT-Hydraulic Crimp Tooling Solutions-1654519](#)

English

Bottoming Dies

English

Instruction Sheets

[Instruction Sheet \(U.S.\)](#)

English

[Instruction Sheet \(U.S.\)](#)

English