



Application Tooling > Insertion & Extraction Tools



Insertion & Extraction Tool Type: **Contact Extraction**

Insertion & Extraction Tool Application: **Contact-to-Housing**

Features

Product Type Features

Insertion & Extraction Tool Type	Contact Extraction
Insertion & Extraction Tool Application	Contact-to-Housing

Product Compliance

[For compliance documentation, visit the product page on TE.com>](#)

EU RoHS Directive 2011/65/EU	Compliant
EU ELV Directive 2000/53/EC	Out of Scope
China RoHS 2 Directive MIIT Order No 32, 2016	No Restricted Materials Above Threshold
EU REACH Regulation (EC) No. 1907/2006	Current ECHA Candidate List: JUNE 2023 (235) Candidate List Declared Against: JUNE 2022 (224) Does not contain REACH SVHC
Halogen Content	Low Halogen - Br, Cl, F, I < 900 ppm per homogenous material. Also BFR/CFR/PVC Free
Solder Process Capability	Not applicable for solder process capability

Product Compliance Disclaimer

This information is provided based on reasonable inquiry of our suppliers and represents our current actual knowledge based on the information they provided. This information is subject to change. The part numbers that TE has identified as EU RoHS compliant have a maximum concentration of 0.1% by weight in homogenous materials for lead, hexavalent chromium, mercury, PBB, PBDE, DBP, BBP, DEHP, DIBP, and 0.01% for cadmium, or qualify for an exemption to these limits as defined in the Annexes of Directive 2011/65/EU (RoHS2). Finished electrical and electronic equipment products will be CE marked as required by Directive 2011/65/EU. Components may not be CE marked. Additionally, the part numbers that TE has identified as EU ELV compliant have a maximum concentration of 0.1% by weight in homogenous materials for lead, hexavalent chromium, and mercury, and 0.01% for cadmium, or qualify for an exemption to these limits as defined in the Annexes of Directive 2000/53/EC (ELV). Regarding the REACH Regulation, the information TE provides

on SVHC in articles for this part number is based on the latest European Chemicals Agency (ECHA) 'Guidance on requirements for substances in articles' posted at this URL: <https://echa.europa.eu/guidance-documents/guidance-on-reach>

Compatible Parts



TE Part # 60619-5
CMNL SOK AUBR L/P

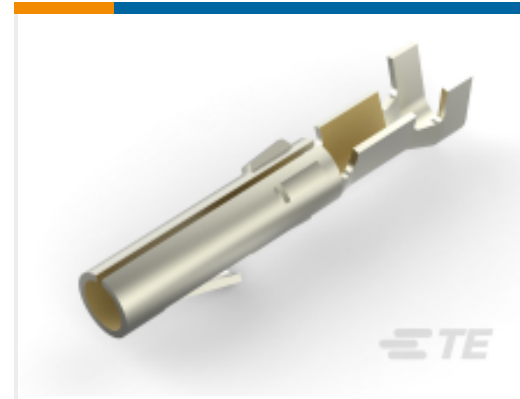

TE Part # 60617-5
CMNL SOK AUBR L/P

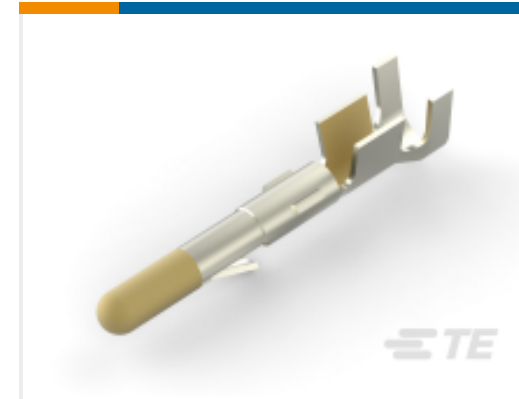

TE Part # 60618-5
CMNL PIN AUBR L/P



TE Part # 60618-4
CMNL PIN PTPPHBZL/P



TE Part # 60617-4
CMNL SOK PTPPHBZ L/P



TE Part # 61174-1
CMNL PIN L/P PTBR



TE Part # 61173-1
CMNL SOK 30-22 PTBR L/P



TE Part # 60619-1
CMNL SOK PTPBR L/P



TE Part # 60620-1
CMNL PIN 20-14 TPBR L/P



TE Part # 60617-1
CMNL SOK SNBR L/P



TE Part # 163304-2
MATENLOK SOCKET SDW



TE Part # 163305-2
MATENLOK PIN SDW



TE Part # 60619-4
CMNL SOK PTPPHBZ L/P



TE Part # 61118-5
CMNL PIN 20-14 AUNIBR



TE Part # 61314-6
CMNL SOK S/F 24-18 .0125AUPHBZ



TE Part # 61116-4
CMNL PIN 24-18 PTPHBZ



TE Part # 61117-5
CMNL SOK 20-14 AUBR



TE Part # 61314-4
CMNL SOK 24-18 TPPHBZ



TE Part # 163302-6
MATENLOK SIDE WAY



TE Part # 163555-6
MATENLOK PIN

Also in the Series | Commercial MATE-N-LOK



Connector Caps & Covers(2)



Connector Contacts(20)



Connector Seals & Cavity Plugs(1)



Crimp Wire Pins, Tabs & Ferrules(2)



Insertion & Extraction Tools(3)

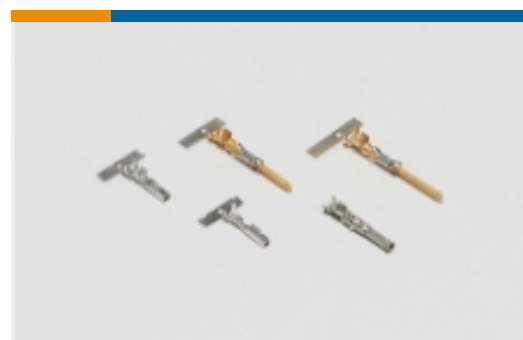

Power Contacts(129)



Rectangular Connector Housings(11)



Rectangular Power Connectors(169)



Standard Circular Connectors(2)



Standard Rectangular Connectors(7)



Wire-to-Board Connector Contacts(1)

Customers Also Bought



TE Part #1-6609037-8
3EMC3=F8146



TE Part #6609048-6
6EQ3=F7263 S0



TE Part #3-826646-2
32P AMPMODU II STIFT LEI



TE Part #350218-2
UMNL PIN 20-14 .0126AUBR



TE Part #53241-2
PG SPR SPD 22-16COMM 22-18MIL8



TE Part #52957-3
TERMINAL,PG SPR SPD 16-14 10



TE Part #1801410001
RPS-1K-8-4/2.0-4



TE Part #7-146274-0
20 MODII HDR SRST B/A .100CL

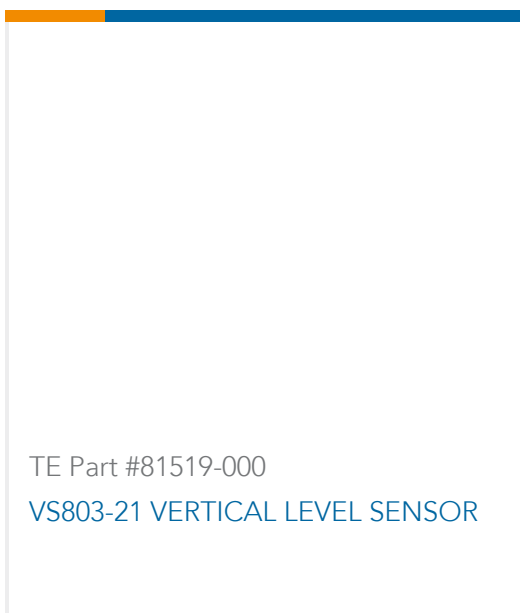

TE Part #81519-000
VS803-21 VERTICAL LEVEL SENSOR

Documents

Product Drawings

[EXTRACTION TOOL](#)

English

Instruction Sheets

[Instruction Sheet \(U.S.\)](#)

English