

45436 ✓ ACTIVE

AMP

TE Internal #: 45436

Hand Crimping Tools, Premium Crimp Tooling, Removable /Interchangeable, MIL Spec / TE Product Specification (114-), Manual / Battery / Hydraulic

[View on TE.com >](#)



Application Tooling > Hand Crimping Tools



Tool Grade: Premium Crimp Tooling

Die Sets Type: Removable/Interchangeable

Specification Type: MIL Spec, TE Product Specification (114-)

TE Certification: Yes – Certificate Included

Power Technology Type: Battery, Hydraulic, Manual

Features

Other

Crimp Form-Wire Barrel Type	Closed Barrel - W Crimp
Tool Grade	Premium Crimp Tooling
Die Sets Type	Removable/Interchangeable
Specification Type	MIL Spec, TE Product Specification (114-)
TE Certification	Yes – Certificate Included
Power Technology Type	Battery, Hydraulic, Manual
Tooling Type	Die Assembly

Product Compliance

[For compliance documentation, visit the product page on TE.com>](#)

EU RoHS Directive 2011/65/EU	Compliant
EU ELV Directive 2000/53/EC	Out of Scope
China RoHS 2 Directive MIIT Order No 32, 2016	No Restricted Materials Above Threshold
EU REACH Regulation (EC) No. 1907/2006	Current ECHA Candidate List: JUNE 2023 (235) Candidate List Declared Against: JAN 2021 (211) Does not contain REACH SVHC
Halogen Content	Low Halogen - Br, Cl, F, I < 900 ppm per homogenous material. Also BFR/CFR/PVC

Free













Solder Process Capability

Not reviewed for solder process capability

Product Compliance Disclaimer

This information is provided based on reasonable inquiry of our suppliers and represents our current actual knowledge based on the information they provided. This information is subject to change. The part numbers that TE has identified as EU RoHS compliant have a maximum concentration of 0.1% by weight in homogenous materials for lead, hexavalent chromium, mercury, PBB, PBDE, DBP, BBP, DEHP, DIBP, and 0.01% for cadmium, or qualify for an exemption to these limits as defined in the Annexes of Directive 2011/65/EU (RoHS2). Finished electrical and electronic equipment products will be CE marked as required by Directive 2011/65/EU. Components may not be CE marked. Additionally, the part numbers that TE has identified as EU ELV compliant have a maximum concentration of 0.1% by weight in homogenous materials for lead, hexavalent chromium, and mercury, and 0.01% for cadmium, or qualify for an exemption to these limits as defined in the Annexes of Directive 2000/53/EC (ELV). Regarding the REACH Regulation, the information TE provides on SVHC in articles for this part number is based on the latest European Chemicals Agency (ECHA) 'Guidance on requirements for substances in articles' posted at this URL: <https://echa.europa.eu/guidance-documents/guidance-on-reach>

Compatible Parts

 <p>TE Part # 320744 TERMINAL,SOLIS R 1/0 5/8</p>	 <p>TE Part # 36957 SPLICE,SOLIS BUTT 1/0</p>	 <p>TE Part # 36915 TERMINAL,SOLIS R 1/0 1/4</p>	 <p>TE Part # 36916 TERMINAL,SOLIS R 1/0 5/16</p>
 <p>TE Part # 36917 TERMINAL,SOLIS R 1/0 3/8</p>	 <p>TE Part # 36946 SPLICE,SOLIS PARA 1/0</p>	 <p>TE Part # 320748 TERMINAL,SOLIS R 1/0 3/4</p>	 <p>TE Part # 55821-1 BODY BRAZED RING 1/0 1/4</p>
 <p>TE Part # 696711-1 STRATOTHERM,1/0,3/8,NIPL,45</p>	 <p>TE Part # 323179 TERMINAL SOLIS R HR 1/0 M6(1/4)</p>	 <p>TE Part # 605181-1 1/0 BUTT SPLICE & HST PRE-PAK</p>	 <p>TE Part # 1752868-1 HYP10 12-350MCM 18T HEAD</p>



Customers Also Bought

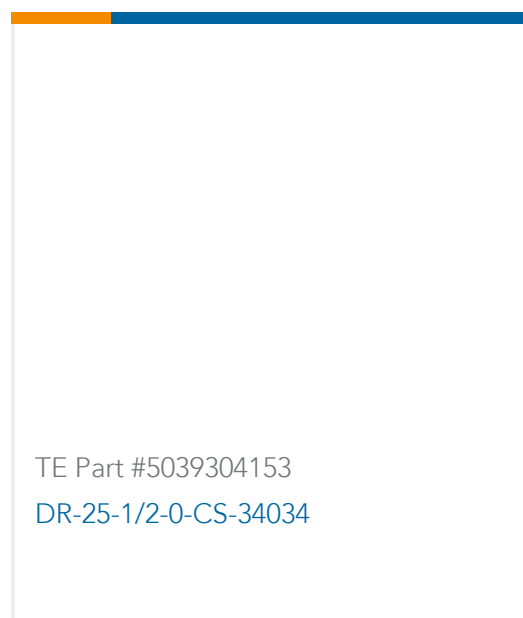
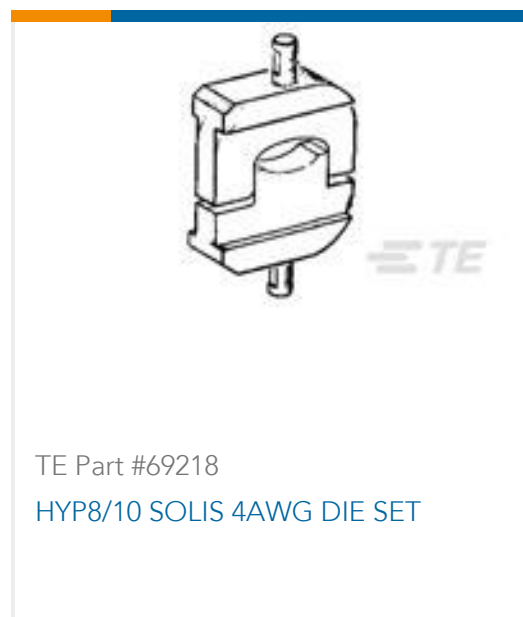

Documents



Datasheets & Catalog Pages

[AT-Hydraulic Crimp Tooling Solutions-1654519](#)

English

Bottoming Dies

English

Instruction Sheets

[Instruction Sheet \(U.S.\)](#)

English