

42566-1 ✓ ACTIVE

FASTON | FASTON 187

TE Internal #: 42566-1

Quick Disconnects, Receptacle, 20 – 16 AWG Wire Size, .51 – 1.31 mm<sup>2</sup> Wire Size, Mating Tab Width 4.75 mm [.187 in], Straight, Brass, FASTON 187

[View on TE.com >](#)



Terminals & Splices > Quick Disconnects

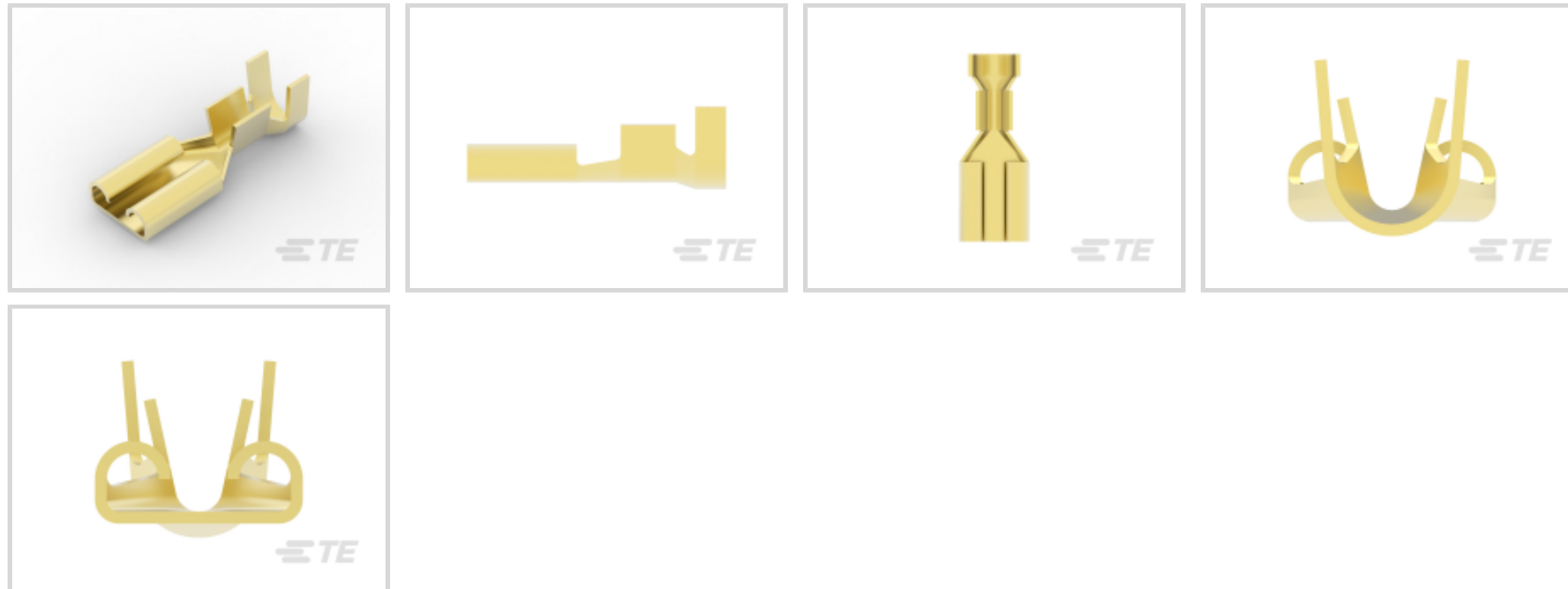

Quick Disconnect Terminal Type: **Receptacle**

Wire Size: .51 – 1.31 mm<sup>2</sup>

Mating Tab Width: 4.75 mm [.187 in]

Mating Tab Thickness: .51 mm [.02 in]

## Features

### Product Type Features

Insertion Force	Low
-----------------	-----

### Configuration Features

Connection Capacity	Single
---------------------	--------

Compatible With Wire & Cable Type	Discrete Wire
-----------------------------------	---------------

### Contact Features

Quick Disconnect Terminal Type	Receptacle
--------------------------------	------------

Mating Tab Width	4.75 mm [.187 in]
------------------	-------------------

Mating Tab Thickness	.51 mm [.02 in]
----------------------	-----------------

Terminal Orientation	Straight
----------------------	----------

Contact Base Material	Brass
-----------------------	-------

Terminal Plating Material	Unplated
---------------------------	----------

Crimp Type	F-Crimp
------------	---------

Barrel Type	Open
-------------	------

### Termination Features



Product Terminates To	Wire & Cable
-----------------------	--------------

### Mechanical Attachment

Wire Insulation Support	With
Mating Retention Type	Dimple

### Dimensions

Terminal Material Thickness	.3 mm[.012 in]
Product Length	16.07 mm[.633 in]
Compatible Insulation Diameter Range	2.29 – 3.3 mm[.09 – .13 in]
Wire Size	.51 – 1.31 mm <sup>2</sup>

### Usage Conditions

Insulation Option	Uninsulated
Operating Temperature Range	-40 – 110 °C[-40 – 230 °F]

### Industry Standards

Agency/Standard	CSA, UL
-----------------	---------

### Packaging Features

Packaging Quantity	500
Packaging Method	Loose Piece/Carton

### Other

Line	Premier
------	---------

## Product Compliance

[For compliance documentation, visit the product page on TE.com>](#)

EU RoHS Directive 2011/65/EU	Compliant
EU ELV Directive 2000/53/EC	Compliant
China RoHS 2 Directive MIIT Order No 32, 2016	No Restricted Materials Above Threshold
EU REACH Regulation (EC) No. 1907/2006	Current ECHA Candidate List: JUNE 2023 (235) Candidate List Declared Against: JUNE 2023 (235) Does not contain REACH SVHC
Halogen Content	Low Halogen - Br, Cl, F, I < 900 ppm per homogenous material. Also BFR/CFR/PVC Free
Solder Process Capability	Not applicable for solder process capability

Product Compliance Disclaimer

This information is provided based on reasonable inquiry of our suppliers and represents our current actual knowledge based on the information they provided. This information is subject to change. The part numbers that TE has identified as EU RoHS compliant have a maximum concentration of 0.1% by weight in homogenous materials for lead, hexavalent chromium, mercury, PBB, PBDE, DBP, BBP, DEHP, DIBP, and 0.01% for cadmium, or qualify for an exemption to these limits as defined in the Annexes of Directive 2011/65/EU (RoHS2). Finished electrical and electronic equipment products will be CE marked as required by Directive 2011/65/EU. Components may not be CE marked. Additionally, the part numbers that TE has identified as EU ELV compliant have a maximum concentration of 0.1% by weight in homogenous materials for lead, hexavalent chromium, and mercury, and 0.01% for cadmium, or qualify for an exemption to these limits as defined in the Annexes of Directive 2000/53/EC (ELV). Regarding the REACH Regulation, the information TE provides on SVHC in articles for this part number is based on the latest European Chemicals Agency (ECHA) 'Guidance on requirements for substances in articles' posted at this URL: <https://echa.europa.eu/guidance-documents/guidance-on-reach>

### Compatible Parts



TE Part # 61045-2  
FASTON .187 SERIES (4.8 MM) TPBR



TE Part # 170141-2  
187 FASTON, FLAG, REC., 20-16 AWG, TPBR



TE Part # 91509-1  
CCII FASTON 187 REC 20-16 ASSY

### Also in the Series | FASTON 187



Crimp Terminal Housings(42)



Insertion & Extraction Tools(1)



Joints & Splices(1)



PCB Terminals(42)



Quick Disconnects(209)



Splices(1)

### Customers Also Bought



TE Part #2-6609006-2  
3EJT1=F8134



TE Part #360010-1  
187 FASTON HSG., REC., 3 POS,  
NATRUAL



TE Part #5556416-1  
MJ, TE, 8P



TE Part #328730  
SPLICE, N CE 22-10

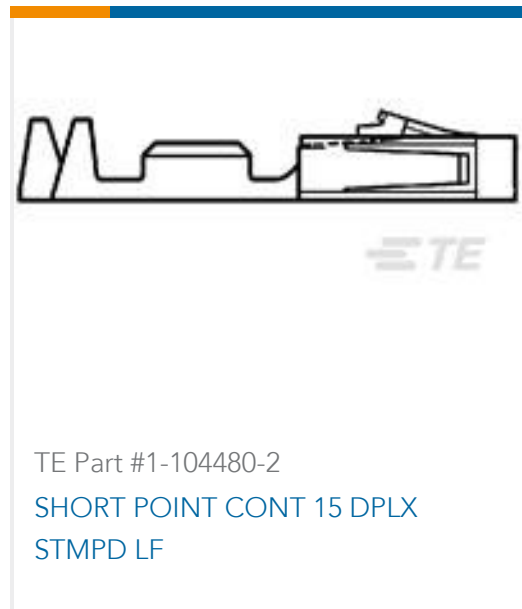

TE Part #1-104480-2  
SHORT POINT CONT 15 DPLX  
STMPD LF



TE Part #2-6609107-0  
PS0SXSS60=C1048



TE Part #42741-1  
250 FASTON, REC., 18-14, BR



TE Part #103648-3  
04 MTE RCPT HSG SR RIB .100CL



TE Part #1333200-3  
ANVIL, COMBINATION(.042)



TE Part #8-1415022-1  
RY612060

## Documents

### Product Drawings

187 FASTON REC 20-16 AWG BR

English

### CAD Files

Customer View Model

[ENG\\_CVM\\_CVM\\_42566-1\\_U.2d\\_dxf.zip](#)

English

### 3D PDF

3D

Customer View Model

[ENG\\_CVM\\_CVM\\_42566-1\\_U.3d\\_igs.zip](#)

English

Customer View Model

[ENG\\_CVM\\_CVM\\_42566-1\\_U.3d\\_stp.zip](#)

English

By downloading the CAD file I accept and agree to the [Terms and Conditions](#) of use.

## Datasheets & Catalog Pages



[FASTIN\\_FASTON\\_Product\\_Line](#)

English

---

[Product Specifications](#)

[Application Specification](#)

English

---

[Product Environmental Compliance](#)

[Product Compliance](#)

English

[Product Compliance](#)

English

---

[Instruction Sheets](#)

[Instruction Sheet \(U.S.\)](#)

English

[Hand Crimping Tool 90180-2](#)

English

---

[Agency Approvals](#)

[Agency Approval Document](#)

English