

42415-1 ✓ ACTIVE

FASTON | FASTON 110

TE Internal #: 42415-1

Quick Disconnects, Receptacle, 24 – 22 AWG Wire Size, .2 – .35 mm² Wire Size, 404 – 643 CMA Wire Size, Mating Tab Width 2.8 mm [.11 in], FASTON 110

[View on TE.com >](#)



Terminals & Splices > Quick Disconnects

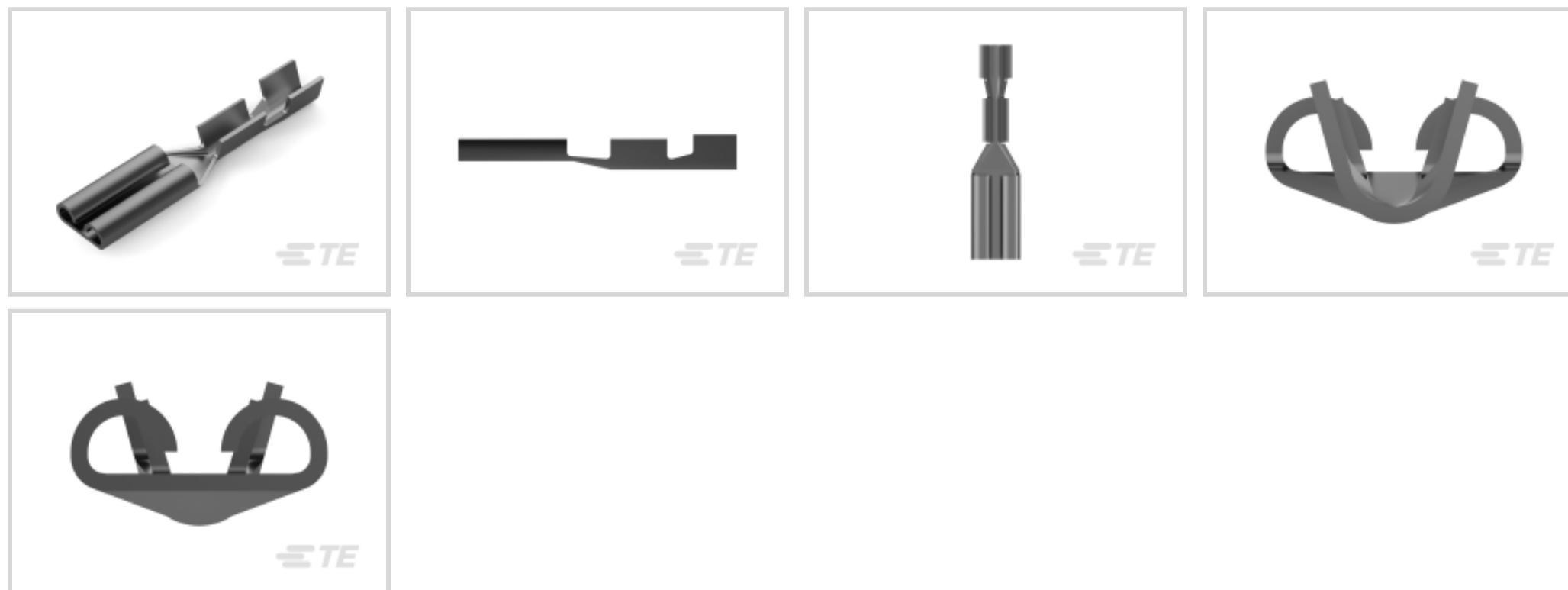

Quick Disconnect Terminal Type: **Receptacle**

Wire Size: **404 – 643 CMA**

Mating Tab Width: **2.8 mm [.11 in]**

Features

Configuration Features

Connection Capacity	Single
Compatible With Wire & Cable Type	Discrete Wire

Contact Features

Quick Disconnect Terminal Type	Receptacle
Mating Tab Width	2.8 mm [.11 in]
Mating Tab Thickness	.41 mm [.016 in]
Terminal Orientation	Straight
Contact Base Material	Brass
Terminal Plating Material	Tin
Crimp Type	F-Crimp
Barrel Type	Open

Termination Features

Product Terminates To	Wire & Cable
-----------------------	--------------

Mechanical Attachment

Wire Insulation Support	With
-------------------------	------



Mating Retention Type	Dimple
-----------------------	--------

Dimensions

Terminal Material Thickness	.25 mm[.01 in]
Product Length	16.13 mm[.635 in]
Compatible Insulation Diameter Range	1.01 – 1.52 mm[.04 – .06 in]
Wire Size	404 – 643 CMA

Usage Conditions

Insulation Option	Uninsulated
Operating Temperature Range	-40 – 105 °C[-40 – 221 °F]

Industry Standards

Agency/Standard	UL
-----------------	----

Packaging Features

Packaging Quantity	15000
Packaging Method	Reel

Product Compliance

[For compliance documentation, visit the product page on TE.com>](#)

EU RoHS Directive 2011/65/EU	Compliant
EU ELV Directive 2000/53/EC	Compliant
China RoHS 2 Directive MIIT Order No 32, 2016	No Restricted Materials Above Threshold
EU REACH Regulation (EC) No. 1907/2006	Current ECHA Candidate List: JUNE 2023 (235) Candidate List Declared Against: JUNE 2023 (235) Does not contain REACH SVHC
Halogen Content	Low Halogen - Br, Cl, F, I < 900 ppm per homogenous material. Also BFR/CFR/PVC Free
Solder Process Capability	Not applicable for solder process capability

Product Compliance Disclaimer

This information is provided based on reasonable inquiry of our suppliers and represents our current actual knowledge based on the information they provided. This information is subject to change. The part numbers that TE has identified as EU RoHS compliant have a maximum concentration of 0.1% by weight in homogenous materials for lead, hexavalent chromium, mercury, PBB, PBDE, DBP, BBP, DEHP, DIBP, and 0.01% for cadmium, or qualify for an exemption to these limits as defined in the Annexes of Directive 2011/65/EU (RoHS2). Finished electrical and electronic equipment products will be CE marked as required by Directive 2011/65/EU. Components may not be CE marked. Additionally, the part numbers that TE has identified as EU ELV compliant have a maximum concentration of 0.1% by weight in homogenous materials for lead, hexavalent chromium, and mercury, and 0.01% for cadmium, or qualify for an exemption to these limits

as defined in the Annexes of Directive 2000/53/EC (ELV). Regarding the REACH Regulation, the information TE provides on SVHC in articles for this part number is based on the latest European Chemicals Agency (ECHA) 'Guidance on requirements for substances in articles' posted at this URL: <https://echa.europa.eu/guidance-documents/guidance-on-reach>

Compatible Parts



TE Part # 2063846-1
CCII 110 FASTON REC 24-18 ASSY



TE Part # 2150043-1
OCEAN_2.0_Applicator-S-062F0700



TE Part # 2150043-2
OCEAN_2.0_Applicator-S-062F0700



TE Part # 7-2150043-1
OCEAN_2.0_Applicator-S-062F0700



TE Part # 7-2150043-2
OCEAN_2.0_Applicator-S-062F0700



KIT
REPRESENTATION ONLY

TE Part # 7-2150043-7
OCEAN_2.0_SPARE_PART_KIT-062F0700



TE Part # 2-2150043-1
OCEAN_2.0_Applicator-S-062F0700



TE Part # 2-2150043-2
OCEAN_2.0_Applicator-S-062F0700

Also in the Series | FASTON 110

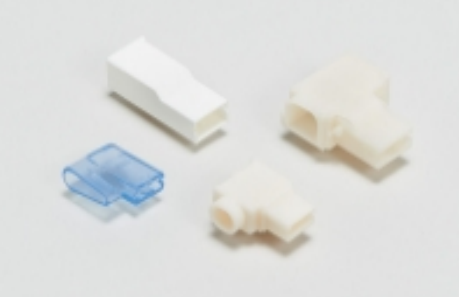

Crimp Terminal Housings(13)



Insertion & Extraction Tools(1)



PCB Terminals(21)



Quick Disconnects(171)

Customers Also Bought

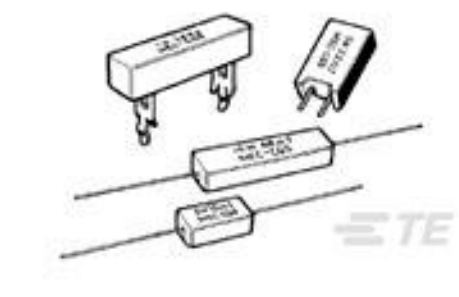

TE Part #2-1879009-5
SQB30 220R 5% 6.35MM FASTON



TE Part #3-643228-0
03P UMNL HDR ASSY R/A 94VO LF



TE Part #184006-1
2 POS. PLUG ASSY, KEY D, GREEN



TE Part #184046-1
4 POS. PLUG ASSY, KEY A

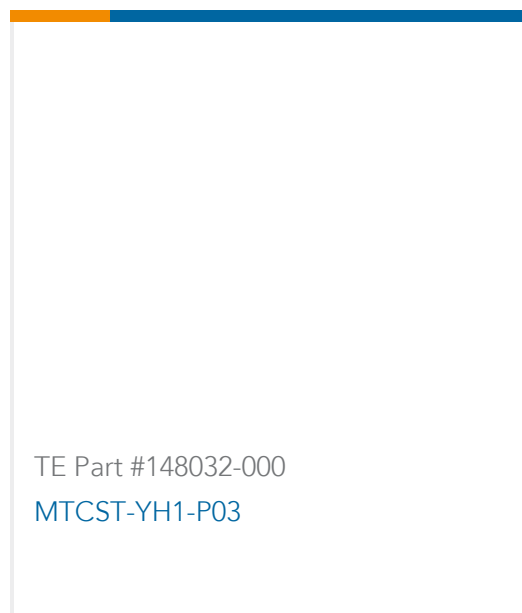
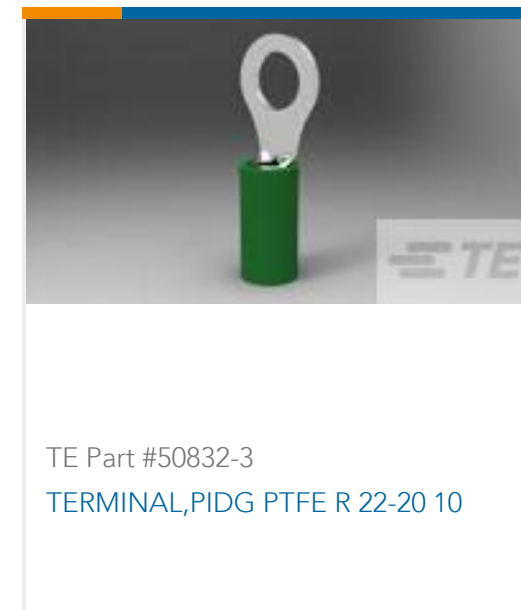
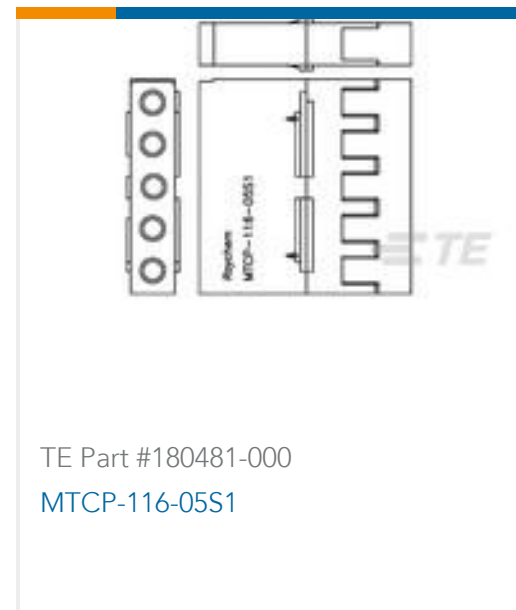

Documents

Product Drawings

[110 FASTON REC 24-22 AWG TPBR](#)

English

CAD Files

Customer View Model

[ENG_CVM_CVM_42415-1_BC.2d_dxf.zip](#)

English

[3D PDF](#)

3D

Customer View Model

[ENG_CVM_CVM_42415-1_BC.3d_igs.zip](#)

English

Customer View Model

[ENG_CVM_CVM_42415-1_BC.3d_stp.zip](#)

English

By downloading the CAD file I accept and agree to the [Terms and Conditions](#) of use.

Datasheets & Catalog Pages

[82004 FASTON Terminals \(Insulated and Uninsulated\) Catalog - FASTON Receptacles Section](#)

English

Product Specifications

[Application Specification](#)

English

Product Environmental Compliance

[TE Material Declaration](#)

42415-1

Quick Disconnects, Receptacle, 24 – 22 AWG Wire Size, .2 – .35 mm² Wire Size, 404 – 643 CMA Wire Size, Mating Tab Width 2.8 mm [.11 in], FASTON 110



English