

42399-1 ✓ ACTIVE

FASTON | FASTON 110

TE Internal #: 42399-1

Quick Disconnects, Receptacle, 20 – 18 AWG Wire Size, .51 – .82 mm<sup>2</sup> Wire Size, Mating Tab Width 2.8 mm [.11 in], Straight, Brass, FASTON 110

[View on TE.com >](#)



Terminals & Splices > Quick Disconnects

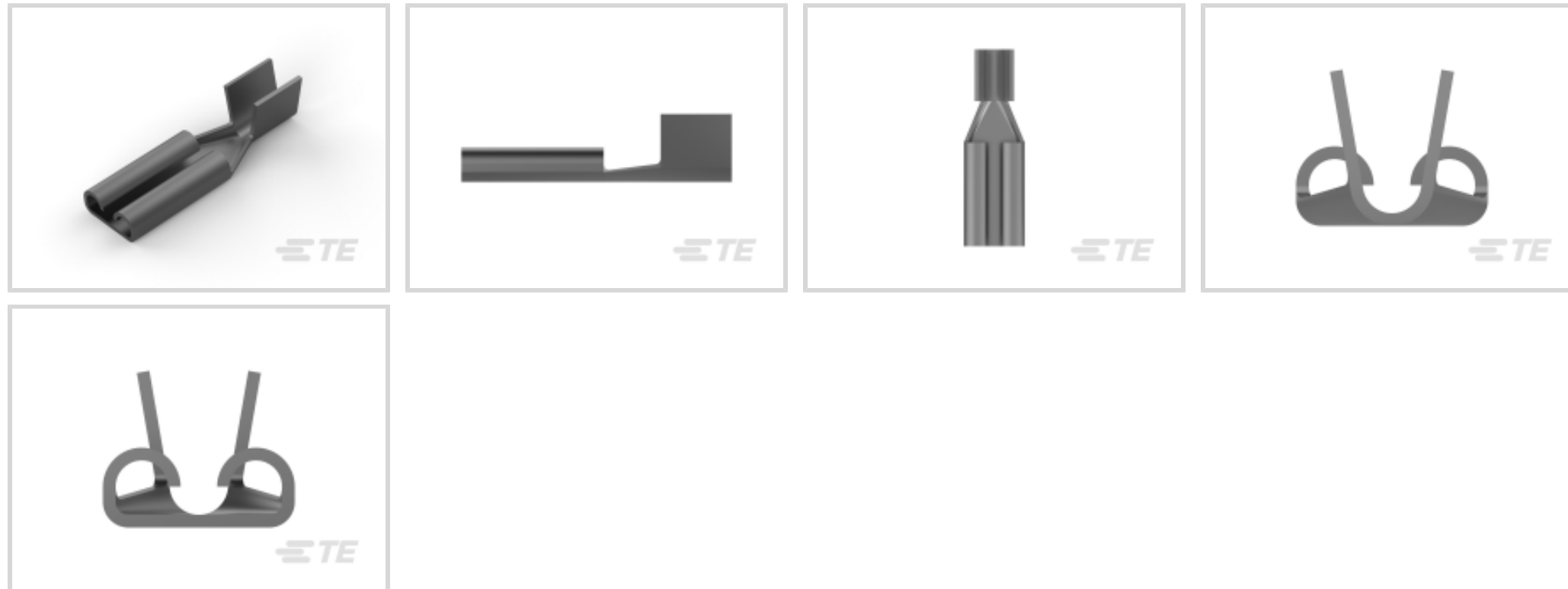

Quick Disconnect Terminal Type: **Receptacle**

Wire Size: .51 – .82 mm<sup>2</sup>

Mating Tab Width: 2.8 mm [.11 in]

Mating Tab Thickness: .51 mm [.02 in]

## Features

### Configuration Features

Connection Capacity	Single
Compatible With Wire & Cable Type	Discrete Wire

### Contact Features

Quick Disconnect Terminal Type	Receptacle
Mating Tab Width	2.8 mm [.11 in]
Mating Tab Thickness	.51 mm [.02 in]
Terminal Orientation	Straight
Contact Base Material	Brass
Terminal Plating Material	Tin
Crimp Type	F-Crimp
Barrel Type	Open

### Termination Features

Product Terminates To	Wire & Cable
-----------------------	--------------

### Mechanical Attachment



Wire Insulation Support	Without
-------------------------	---------

Mating Retention Type	Dimple
-----------------------	--------

### Dimensions

Terminal Material Thickness	.25 mm[.01 in]
-----------------------------	----------------

Product Length	12.07 mm[.475 in]
----------------	-------------------

Wire Size	.51 – .82 mm <sup>2</sup>
-----------	---------------------------

### Usage Conditions

Insulation Option	Uninsulated
-------------------	-------------

Operating Temperature Range	-40 – 110 °C[-40 – 230 °F]
-----------------------------	----------------------------

### Industry Standards

Agency/Standard	CSA, UL
-----------------	---------

### Packaging Features

Packaging Quantity	25000
--------------------	-------

Packaging Method	Strip/Reel
------------------	------------

### Product Compliance

[For compliance documentation, visit the product page on TE.com>](#)

EU RoHS Directive 2011/65/EU	Compliant
------------------------------	-----------

EU ELV Directive 2000/53/EC	Compliant
-----------------------------	-----------

China RoHS 2 Directive MIIT Order No 32, 2016	No Restricted Materials Above Threshold
---	---

EU REACH Regulation (EC) No. 1907/2006	Current ECHA Candidate List: JUNE 2023 (235) Candidate List Declared Against: JUNE 2023 (235) Does not contain REACH SVHC
--	---

Halogen Content	Low Halogen - Br, Cl, F, I < 900 ppm per homogenous material. Also BFR/CFR/PVC Free
-----------------	---

Solder Process Capability	Not applicable for solder process capability
---------------------------	--

#### Product Compliance Disclaimer

This information is provided based on reasonable inquiry of our suppliers and represents our current actual knowledge based on the information they provided. This information is subject to change. The part numbers that TE has identified as EU RoHS compliant have a maximum concentration of 0.1% by weight in homogenous materials for lead, hexavalent chromium, mercury, PBB, PBDE, DBP, BBP, DEHP, DIBP, and 0.01% for cadmium, or qualify for an exemption to these limits as defined in the Annexes of Directive 2011/65/EU (RoHS2). Finished electrical and electronic equipment products will be CE marked as required by Directive 2011/65/EU. Components may not be CE marked. Additionally, the part numbers that TE has identified as EU ELV compliant have a maximum concentration of 0.1% by weight in homogenous materials for lead, hexavalent chromium, and mercury, and 0.01% for cadmium, or qualify for an exemption to these limits

as defined in the Annexes of Directive 2000/53/EC (ELV). Regarding the REACH Regulation, the information TE provides on SVHC in articles for this part number is based on the latest European Chemicals Agency (ECHA) 'Guidance on requirements for substances in articles' posted at this URL: <https://echa.europa.eu/guidance-documents/guidance-on-reach>

## Compatible Parts



TE Part # 151614-1  
110 MINI FASTON,REC.,24-20 AWG, PTBR



TE Part # 63202-2  
110 FASTON REC 18-14 AWG TPBR



TE Part # 2-2150564-1  
OCEAN\_2.0\_Applicator-E-070F



TE Part # 2-2150564-2  
OCEAN\_2.0\_Applicator-E-070FA



TE Part # 2150564-1  
OCEAN\_2.0\_Applicator-E-070F



TE Part # 2150564-2  
OCEAN\_2.0\_Applicator-E-070FA



TE Part # 7-2150564-1  
OCEAN\_2.0\_Applicator-E-070F



TE Part # 7-2150564-2  
OCEAN\_2.0\_Applicator-E-070FA



**KIT**  
REPRESENTATION ONLY

TE Part # 7-2150564-7  
OCEAN\_2.0\_SPARE\_PART\_KIT-070F

## Also in the Series | FASTON 110



Crimp Terminal Housings(13)



Insertion & Extraction Tools(1)



PCB Terminals(21)



Quick Disconnects(171)

## Customers Also Bought

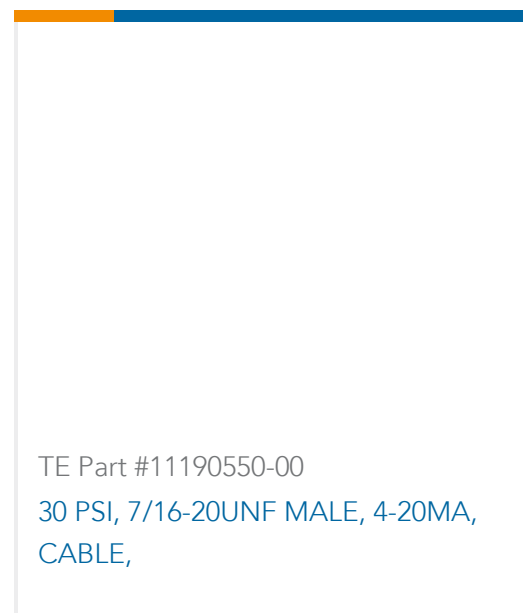
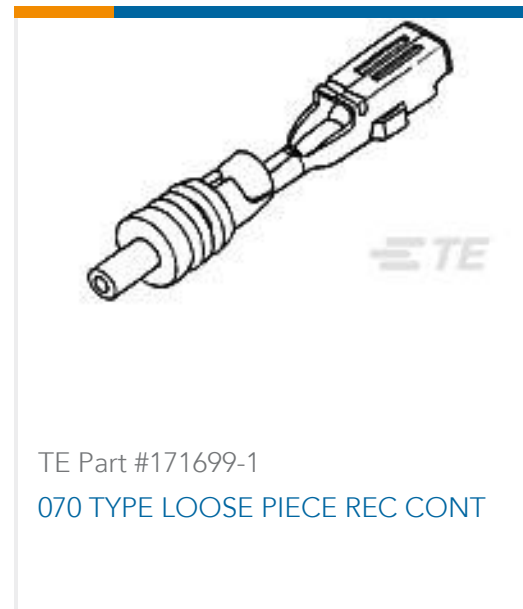

## Documents

### Product Drawings

110 FASTON REC 20-18 AWG TPBR

English

### CAD Files

Customer View Model

[ENG\\_CVM\\_CVM\\_42399-1\\_BK.2d\\_dxf.zip](#)

English

### 3D PDF

3D

Customer View Model

[ENG\\_CVM\\_CVM\\_42399-1\\_BK.3d\\_igs.zip](#)

English

Customer View Model

[ENG\\_CVM\\_CVM\\_42399-1\\_BK.3d\\_stp.zip](#)

English

By downloading the CAD file I accept and agree to the [Terms and Conditions](#) of use.

## Datasheets & Catalog Pages



## 82004 FASTON Terminals (Insulated and Uninsulated) Catalog - FASTON Receptacles Section

English

---

### Product Specifications

#### Application Specification

English

---

### Product Environmental Compliance

#### Product Compliance

English

#### Product Compliance

English