

42281-1 ✓ ACTIVE

FASTIN-FASTON | FASTIN-FASTON 250

TE Internal #: 42281-1

Quick Disconnects, Receptacle, 18 – 14 AWG Wire Size, .82 – 2.08 mm² Wire Size, Mating Tab Width 6.35 mm [.25 in], Straight, Brass, FASTIN-FASTON 250

[View on TE.com >](#)



Terminals & Splices > Quick Disconnects

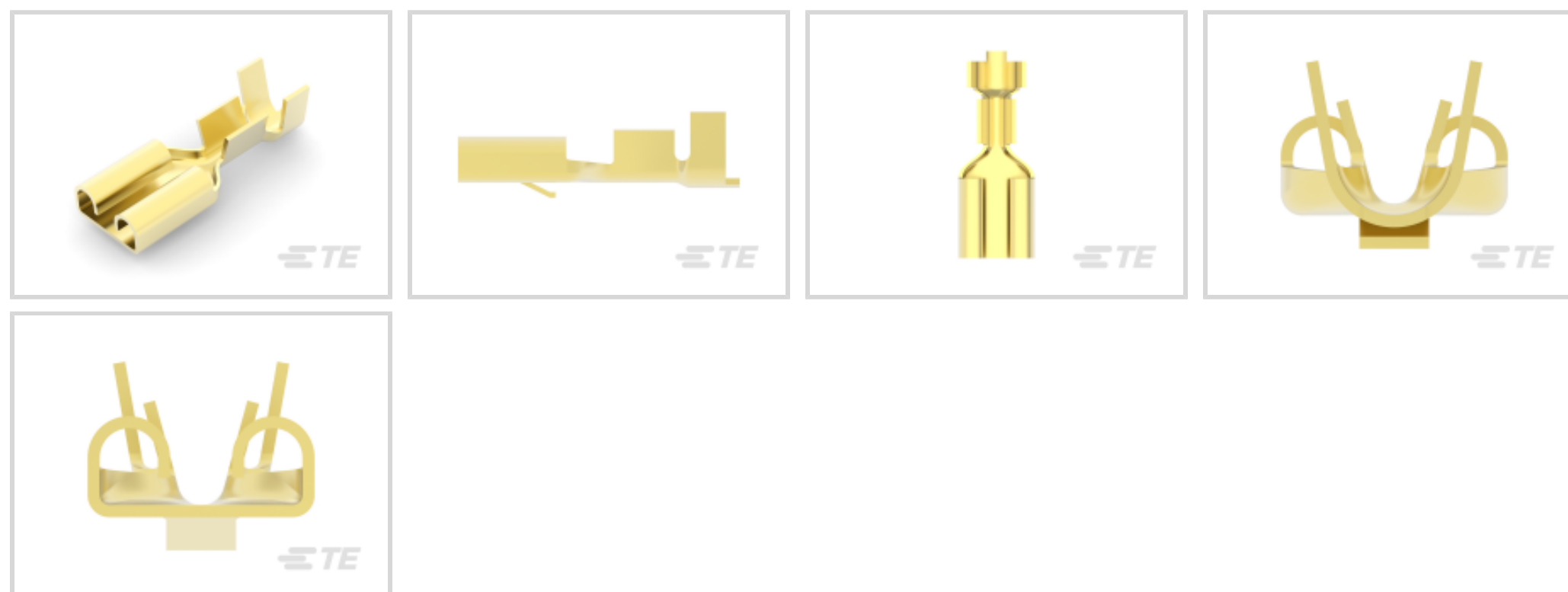

Quick Disconnect Terminal Type: **Receptacle**

Wire Size: **.82 – 2.08 mm²**

Mating Tab Width: **6.35 mm [.25 in]**

Mating Tab Thickness: **.81 mm [.032 in]**

Features

Product Type Features

Insertion Force	Normal
-----------------	--------

Configuration Features

Connection Capacity	Single
---------------------	--------

Compatible With Wire & Cable Type	Discrete Wire
-----------------------------------	---------------

Contact Features

Quick Disconnect Terminal Type	Receptacle
--------------------------------	------------

Mating Tab Width	6.35 mm [.25 in]
------------------	------------------

Mating Tab Thickness	.81 mm [.032 in]
----------------------	------------------

Terminal Orientation	Straight
----------------------	----------

Contact Base Material	Brass
-----------------------	-------

Terminal Plating Material	Unplated
---------------------------	----------

Crimp Type	F-Crimp
------------	---------

Barrel Type	Open
-------------	------

Termination Features



Product Terminates To	Wire & Cable
-----------------------	--------------

Mechanical Attachment

Wire Insulation Support	With
Mating Retention Type	Locking Lance

Dimensions

Terminal Material Thickness	.41 mm[.016 in]
Product Length	19.05 mm[.75 in]
Compatible Insulation Diameter Range	2.79 – 4.32 mm[.11 – .17 in]
Wire Size	.82 – 2.08 mm ²

Usage Conditions

Insulation Option	Uninsulated
Operating Temperature Range	-40 – 110 °C[-40 – 230 °F]

Industry Standards

Agency/Standard	CSA, UL
-----------------	---------

Packaging Features

Packaging Quantity	11000
Packaging Method	Strip/Reel

Product Compliance

[For compliance documentation, visit the product page on TE.com>](#)

EU RoHS Directive 2011/65/EU	Compliant
EU ELV Directive 2000/53/EC	Compliant
China RoHS 2 Directive MIIT Order No 32, 2016	No Restricted Materials Above Threshold
EU REACH Regulation (EC) No. 1907/2006	Current ECHA Candidate List: JUNE 2023 (235) Candidate List Declared Against: JUNE 2023 (235) Does not contain REACH SVHC
Halogen Content	Low Halogen - Br, Cl, F, I < 900 ppm per homogenous material. Also BFR/CFR/PVC Free
Solder Process Capability	Not applicable for solder process capability

Product Compliance Disclaimer

This information is provided based on reasonable inquiry of our suppliers and represents our current actual knowledge based on the information they provided. This information is subject to change. The part numbers that TE has identified as EU RoHS compliant have a maximum concentration of 0.1% by weight in homogenous materials for lead, hexavalent chromium, mercury, PBB, PBDE, DBP, BBP, DEHP, DIBP, and 0.01% for cadmium, or qualify for an exemption to these limits as defined in the Annexes of Directive 2011/65/EU (RoHS2). Finished electrical and electronic equipment products will be CE marked as required by Directive 2011/65/EU. Components may not be CE marked. Additionally, the part numbers that TE has identified as EU ELV compliant have a maximum concentration of 0.1% by weight in homogenous materials for lead, hexavalent chromium, and mercury, and 0.01% for cadmium, or qualify for an exemption to these limits as defined in the Annexes of Directive 2000/53/EC (ELV). Regarding the REACH Regulation, the information TE provides on SVHC in articles for this part number is based on the latest European Chemicals Agency (ECHA) 'Guidance on requirements for substances in articles' posted at this URL: <https://echa.europa.eu/guidance-documents/guidance-on-reach>

Compatible Parts

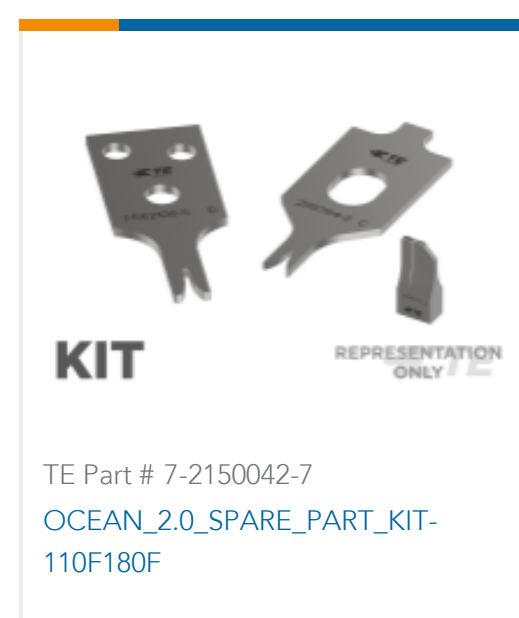

Also in the Series | FASTIN-FASTON 250



Crimp Terminal Housings(211)



Insertion & Extraction Tools(2)



PCB Terminals(2)

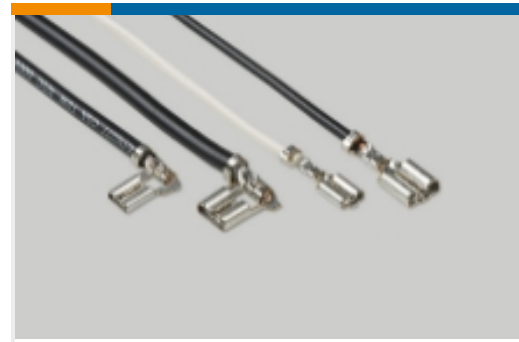

Quick Disconnects(254)

Customers Also Bought

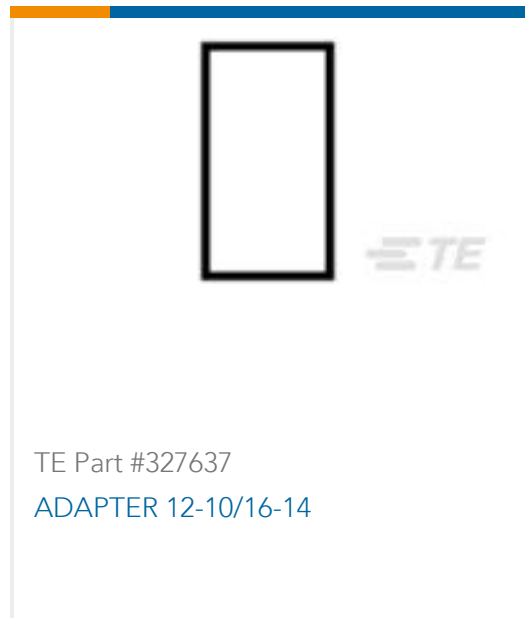

TE Part #327637
ADAPTER 12-10/16-14



TE Part #1445997-1
CONTACT, 120 PWR PROD,6 AWG



TE Part #1393127-9
PRD-11AG0-120=PRD



TE Part #1-2213767-7
AV19 SPM 5A MOVE RING LED BLUE 12V

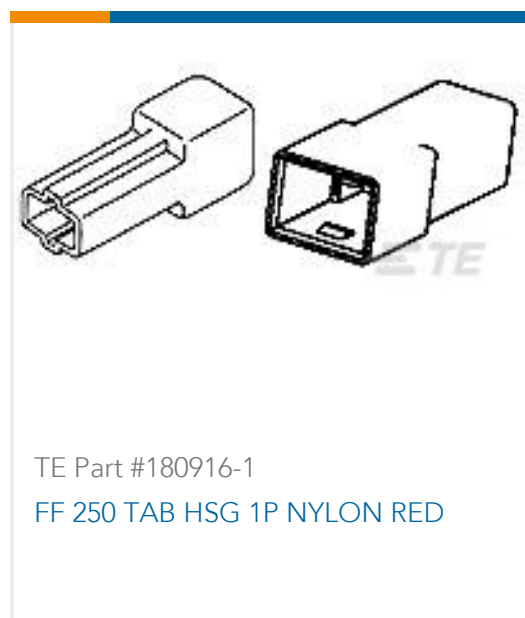

TE Part #180916-1
FF 250 TAB HSG 1P NYLON RED



TE Part #3-1393127-5
PRD-11DG0-12=PRD



TE Part #5-2213767-7
AV19 DPM 5A MOVE RING LED BLUE 12V

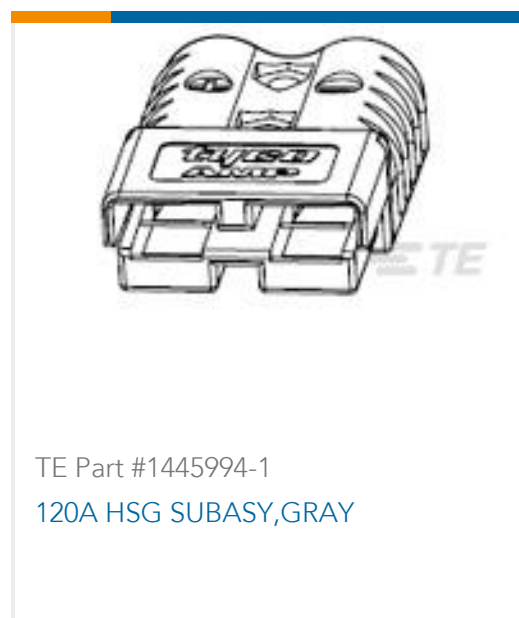

TE Part #1445994-1
120A HSG SUBASY,GRAY



TE Part #CB3126-000
D-1744-02-LF

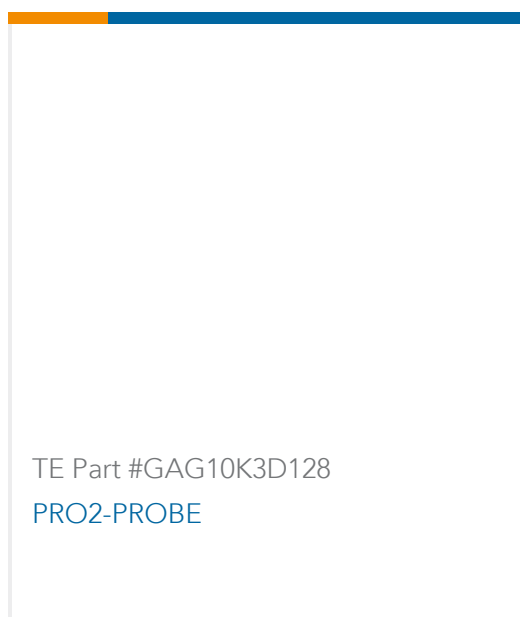

TE Part #GAG10K3D128
PRO2-PROBE

Documents

Product Drawings

[FF 250 REC 18-14AWG BR](#)

English

CAD Files

[3D PDF](#)

[3D](#)



Customer View Model

[ENG_CVM_CVM_42281-1_DJ_c-42281-1-dj.2d_dxf.zip](#)

English

Customer View Model

[ENG_CVM_CVM_42281-1_DJ_c-42281-1-dj.3d_igs.zip](#)

English

Customer View Model

[ENG_CVM_CVM_42281-1_DJ_c-42281-1-dj.3d_stp.zip](#)

English

By downloading the CAD file I accept and agree to the [Terms and Conditions](#) of use.

Datasheets & Catalog Pages

[FASTIN_FASTON_Product_Line](#)

English

[Positive Lock Receptacles](#)

English

Product Specifications

[Application Specification](#)

English

Product Environmental Compliance

[MD_42281-1_0228201804_dmtec](#)

English

[MD_42281-1_0228201804_dmtec](#)

English