

40697 ✓ ACTIVE

TE Internal #: 40697

Closed Ring Tongue Terminal, 22 – 18 AWG, #6 / M3.5 Stud Size,
3.68 mm [.145 in] Stud Diameter, Open Barrel, Straight, Tin,
Uninsulated

[View on TE.com >](#)



Terminals & Splices > Ring Terminals

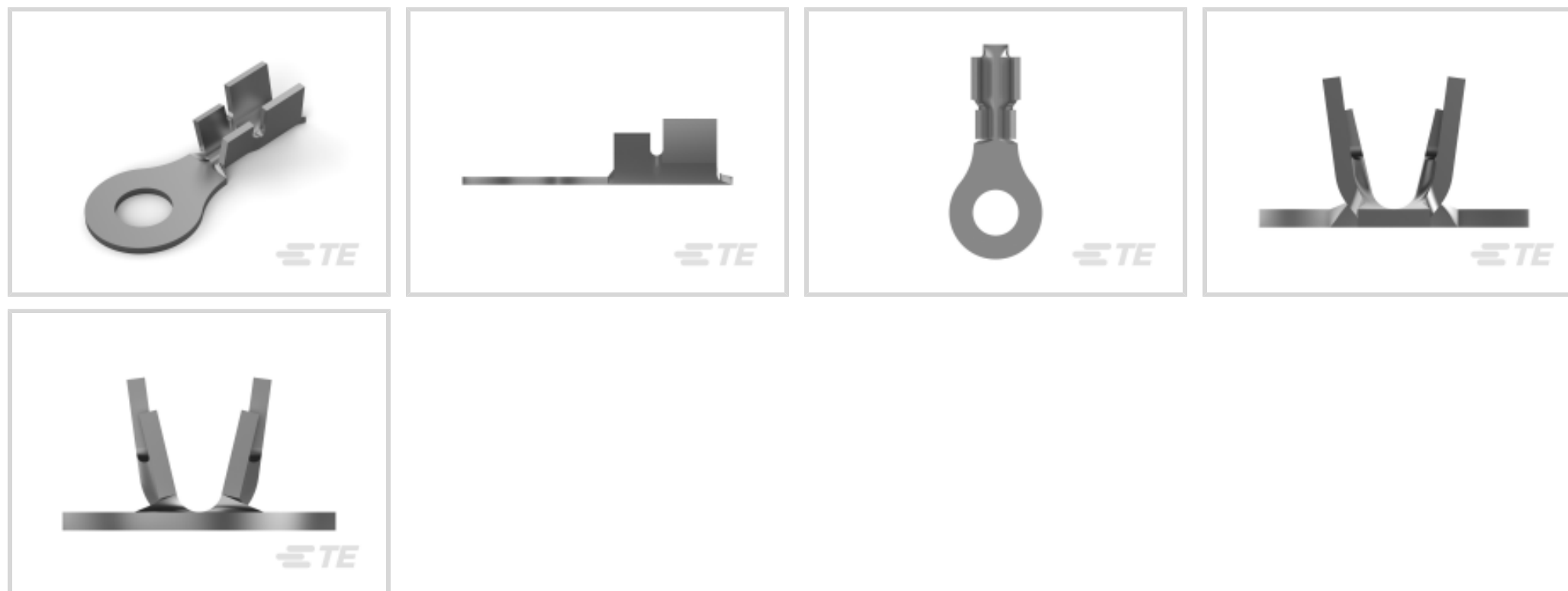

Ring Terminal Product Type: Closed Ring Tongue Terminal

Wire Size: 642 – 1624 CMA

Stud Size: #6, M3.5

Features

Product Type Features

Shape Description	Circular/Oval
Ring Terminal Product Type	Closed Ring Tongue Terminal
Stud Size	#6, M3.5
Sealable	No
Compatible With Discrete Wire Type	Stranded
Wire Insulation Support Retention Type	Insulation Support

Configuration Features

Number of Holes	1
-----------------	---

Body Features

Product Weight	.391 g
----------------	--------

Contact Features

Contact Base Material	Brass
Barrel Type	Open
Terminal Orientation	Straight
Terminal Plating Material	Tin
Contact Underplating Material	Nickel



Mechanical Attachment

Wire Insulation Support	With
-------------------------	------

Dimensions

	.06 in
Wire Size	642 – 1624 CMA
Stud Diameter	3.68 mm [.145 in]
Tongue Thickness	.51 mm [.02 in]
Product Length	16.26 mm [.64 in]
Barrel Inside Diameter	1.27 mm, 2.28 mm [.05 in] [.09 in]
Compatible Insulation Diameter (Max)	2.79 mm [.11 in]
Compatible Insulation Diameter Range	1.52 – 2.79 mm [.06 – .11 in]

Usage Conditions

Insulation Option	Uninsulated
Operating Temperature Range	-40 – 110 °C [-40 – 230 °F]

Operation/Application

Compatible With Wire Base Material	Copper
------------------------------------	--------

Industry Standards

Government Qualified Terminal	No
-------------------------------	----

Packaging Features

Packaging Quantity	20000
Packaging Method	Strip/Reel

Product Compliance

[For compliance documentation, visit the product page on TE.com>](#)

EU RoHS Directive 2011/65/EU	Compliant
EU ELV Directive 2000/53/EC	Compliant
China RoHS 2 Directive MIIT Order No 32, 2016	No Restricted Materials Above Threshold
EU REACH Regulation (EC) No. 1907/2006	Current ECHA Candidate List: JUNE 2023 (235) Candidate List Declared Against: JUNE 2023 (235) Does not contain REACH SVHC
Halogen Content	Low Halogen - Br, Cl, F, I < 900 ppm per homogenous material. Also BFR/CFR/PVC

Free









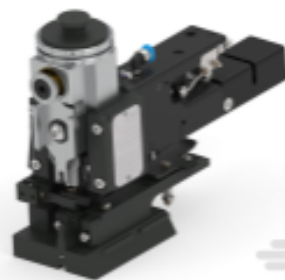

Solder Process Capability

Not applicable for solder process capability

Product Compliance Disclaimer

This information is provided based on reasonable inquiry of our suppliers and represents our current actual knowledge based on the information they provided. This information is subject to change. The part numbers that TE has identified as EU RoHS compliant have a maximum concentration of 0.1% by weight in homogenous materials for lead, hexavalent chromium, mercury, PBB, PBDE, DBP, BBP, DEHP, DIBP, and 0.01% for cadmium, or qualify for an exemption to these limits as defined in the Annexes of Directive 2011/65/EU (RoHS2). Finished electrical and electronic equipment products will be CE marked as required by Directive 2011/65/EU. Components may not be CE marked. Additionally, the part numbers that TE has identified as EU ELV compliant have a maximum concentration of 0.1% by weight in homogenous materials for lead, hexavalent chromium, and mercury, and 0.01% for cadmium, or qualify for an exemption to these limits as defined in the Annexes of Directive 2000/53/EC (ELV). Regarding the REACH Regulation, the information TE provides on SVHC in articles for this part number is based on the latest European Chemicals Agency (ECHA) 'Guidance on requirements for substances in articles' posted at this URL: <https://echa.europa.eu/guidance-documents/guidance-on-reach>

Compatible Parts

 <p>TE Part # 62638-1 RING TONGUE 22-20 AWG TPBR</p>	 <p>TE Part # 2-2150760-2 OCEAN_2.0_Applicator-E-100F140F</p>	 <p>TE Part # 2-2266511-2 OCEAN_2.0_Applicator-S-110F160OV</p>	 <p>TE Part # 2150760-1 OCEAN_2.0_Applicator-E-100F140F</p>
 <p>TE Part # 2150760-2 OCEAN_2.0_Applicator-E-100F140F</p>	 <p>TE Part # 2266511-2 OCEAN_2.0_Applicator-S-110F160OV</p>	 <p>TE Part # 626235-1 TERMINAL RING TONG</p>	 <p>TE Part # 626235-2 RING TONGUE 22-18 AWG 0.50 X 9.144 BR</p>
 <p>TE Part # 7-2150760-1 OCEAN_2.0_Applicator-E-100F140F</p>	 <p>TE Part # 7-2150760-2 OCEAN_2.0_Applicator-E-100F140F</p>	 <p>TE Part # 7-2150760-7 OCEAN_2.0_SPARE_PART_KIT-100F140F</p>	 <p>TE Part # 2-2150760-1 OCEAN_2.0_Applicator-E-100F140F</p>

Customers Also Bought

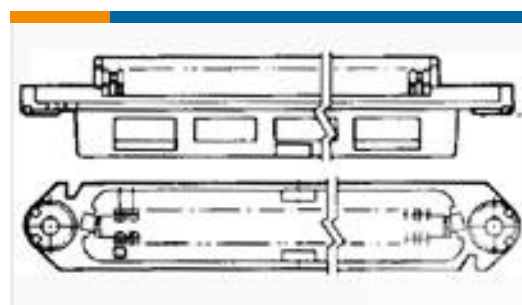

TE Part #229975-1
ASSY,RCPT,50POS,B SLOT,BLK HSG

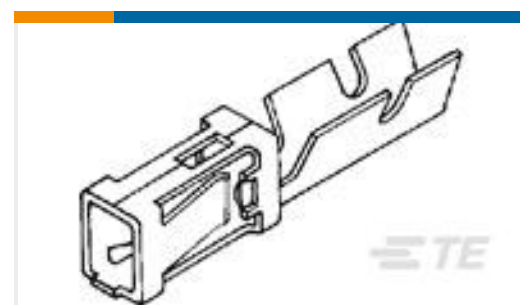

TE Part #102099-5
MOD I RECP STMPD



TE Part #41126
RING 12-10 AWG TPBR



TE Part #41582
RING 190(4.82 MM) 24-20 AWG TPBR



TE Part #2174024-1
LUMAWISE LED HOLDER, TYPE NL2



TE Part #61764-1
RING CRIMP 20-16 AWG BR



TE Part #41013
RING TERMINAL 22-18 AWG TPBR



TE Part #62814-2
250 FASTON FLAG REC 22-18 AWG TPBR



TE Part #229968-1
COVER,DUST,PLUG,BLUE,CHAMP

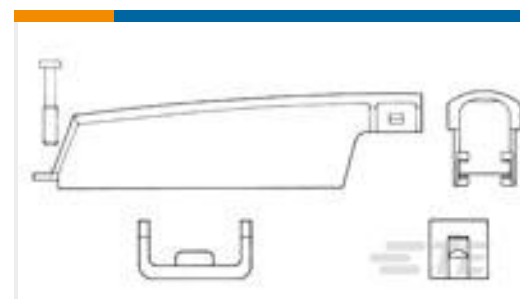

TE Part #229910-1
CLAMP, CABLE "CHAMP PACKAGING"

Documents

Product Drawings

RING TONGUE 22-18 AWG TPBR

English

CAD Files

3D PDF

3D

Customer View Model

[ENG_CVM_CVM_40697_AS_c-40697-as.2d_dxf.zip](#)

English

Customer View Model

[ENG_CVM_CVM_40697_AS_c-40697-as.3d_igs.zip](#)

English

Customer View Model

[ENG_CVM_CVM_40697_AS_c-40697-as.3d_stp.zip](#)

English

By downloading the CAD file I accept and agree to the [Terms and Conditions](#) of use.

Product Specifications



Application Specification

English

Product Environmental Compliance

Product Compliance

English

Product Compliance

English