

4-644617-4 ✓ ACTIVE

MTA 156

TE Internal #: 4-644617-4

Rectangular Power Connectors, Header, Plug, Wire-to-Board, 14 Position, 3.96 mm [.156 in] Centerline, Printed Circuit Board, UL 94V-0, MTA 156

[View on TE.com >](#)



Connectors > Power Connectors > Rectangular Power > Rectangular Power Connectors

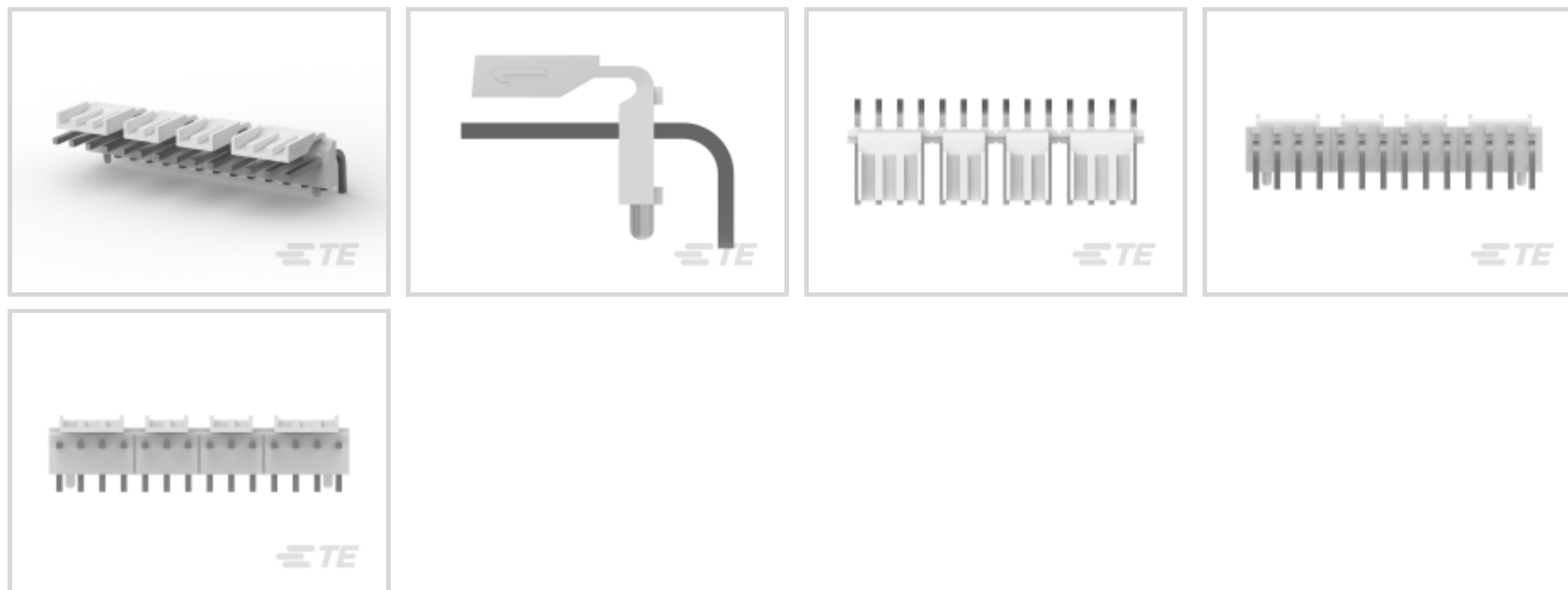

Rectangular Power Connector Type: **Header**

Connector & Housing Type: **Plug**

Connector System: **Wire-to-Board**

Number of Positions: **14**

Centerline (Pitch): **3.96 mm [.156 in]**

Features

Product Type Features

Header Type	Partially Shrouded
Rectangular Power Connector Type	Header
Connector & Housing Type	Plug
Connector System	Wire-to-Board
Sealable	No
Connector & Contact Terminates To	Printed Circuit Board

Configuration Features

Keying & Polarized Position Locations	4&5, 7&8, 10&11
Number of Positions	14
PCB Mount Orientation	Right Angle
Number of Power Positions	14
Number of Rows	1

Electrical Characteristics

Operating Voltage	600 VAC
-------------------	---------



Contact Features

Mating Post Length	11.43 mm[.45 in]
PCB Contact Termination Area Plating Material Thickness	2.54 μm [100 μin]
Contact Layout	Inline
Contact Mating Area Plating Material	Tin
Contact Underplating Material	Nickel
Contact Base Material	Copper Alloy
Contact Current Rating (Max)	7 A
Contact Retention Within Housing	Without
Contact Type	Pin
PCB Contact Termination Area Plating Material	Tin
Contact Mating Area Plating Material Thickness	3.81 – 8.8 μm [150 – 350 μin]

Termination Features

Termination Post & Tail Length	3.3 mm[.13 in]
Termination Method to Printed Circuit Board	Through Hole - Solder

Mechanical Attachment

PCB Mount Alignment Type	Peg
Strain Relief	Without
Mating Alignment Type	Backwall Interruptions Between Posts
Mating Retention	With
Mating Alignment	With
PCB Mount Alignment	With
Panel Mount Feature	Without
PCB Mount Retention	With
PCB Mount Retention Type	Tab
Mating Retention Type	Polarized Lock
Connector Mounting Type	Board Mount

Housing Features

Right Angle Bending Side	Front
Centerline (Pitch)	3.96 mm[.156 in]
Housing Color	Natural
Housing Material	Thermoplastic Polyester - GF



Dimensions

Connector Height	13.84 mm[.545 in]
PCB Thickness (Recommended)	1.57 mm[.062 in]
	2.179 in

Usage Conditions

Operating Temperature Range	-55 – 105 °C[-67 – 221 °F]
-----------------------------	----------------------------

Operation/Application

Circuit Application	Power
---------------------	-------

Industry Standards

CSA Rating	Certified, LR 7189
UL Rating	Recognized
Agency/Standard	CSA, UL
Approved Standards	UL E28476
UL Flammability Rating	UL 94V-0
Glow Wire Rating	Standard Part - Not Glow Wire

Packaging Features

Packaging Quantity	300
Packaging Method	Package

Product Compliance

[For compliance documentation, visit the product page on TE.com>](#)

EU RoHS Directive 2011/65/EU	Compliant
EU ELV Directive 2000/53/EC	Compliant
China RoHS 2 Directive MIIT Order No 32, 2016	No Restricted Materials Above Threshold
EU REACH Regulation (EC) No. 1907/2006	Current ECHA Candidate List: JUNE 2023 (235) Candidate List Declared Against: JAN 2023 (233) Does not contain REACH SVHC
Halogen Content	Not Low Halogen - contains Br or Cl > 900 ppm.
Solder Process Capability	Wave solder capable to 265°C

Product Compliance Disclaimer



This information is provided based on reasonable inquiry of our suppliers and represents our current actual knowledge based on the information they provided. This information is subject to change. The part numbers that TE has identified as EU RoHS compliant have a maximum concentration of 0.1% by weight in homogenous materials for lead, hexavalent chromium, mercury, PBB, PBDE, DBP, BBP, DEHP, DIBP, and 0.01% for cadmium, or qualify for an exemption to these limits as defined in the Annexes of Directive 2011/65/EU (RoHS2). Finished electrical and electronic equipment products will be CE marked as required by Directive 2011/65/EU. Components may not be CE marked. Additionally, the part numbers that TE has identified as EU ELV compliant have a maximum concentration of 0.1% by weight in homogenous materials for lead, hexavalent chromium, and mercury, and 0.01% for cadmium, or qualify for an exemption to these limits as defined in the Annexes of Directive 2000/53/EC (ELV). Regarding the REACH Regulation, the information TE provides on SVHC in articles for this part number is based on the latest European Chemicals Agency (ECHA) 'Guidance on requirements for substances in articles' posted at this URL: <https://echa.europa.eu/guidance-documents/guidance-on-reach>

Compatible Parts



TE Part # CAT-103156-WBHSM
Receptacle Housing: Wire-to-Board, with Mating Alignment, SL156



TE Part # CAT-103156-WBHSN
Receptacle Housing: Wire-to-Board, no Mating Alignment, SL 156



TE Part # 1-640551-4
14P MTA156 COVER



TE Part # 1-643071-4
14P MTA156 FD-THRU COVER



TE Part # 4-640427-4
14P MTA156 CONN ASSY 20AWG YEL



TE Part # 1-643067-4
14P MTA156 MOLDED COVER



TE Part # 4-640428-4
14P MTA156 CONN ASSY 22AWG RED



TE Part # 4-640599-4
14P MTA156 CONN ASSY 18AWG ORA



TE Part # 4-643818-4
14P MTA156 CONN ASSY 20AWG YEL



TE Part # 4-640426-4
14P MTA156 CONN ASSY 18AWG ORA



TE Part # 4-643817-4
14P MTA156 CONN ASSY 18AWG LF



TE Part # 4-640429-4
14P MTA156 CONN ASSY 24AWG WHT



TE Part # 1-640643-4
14P MTA156 COVER FT



TE Part # 4-640600-4
14P MTA156 CONN ASSY 20AWG LF



TE Part # 4-640601-4
14P MTA156 CONN ASSY 22AWG LF



TE Part # 4-640602-4
14P MTA156 CONN ASSY 24AWG LF



TE Part # 4-640605-4
14P MTA156 CONN ASSY 20AWG LF



TE Part # 4-643819-4
14P MTA156 CONN ASSY 22AWG LF



TE Part # 4-644465-4
14P MTA156 CONN ASSY 18AWG ORA



TE Part # 4-644466-4
14P MTA156 CONN ASSY 20AWG YEL

Also in the Series | MTA 156



Insertion & Extraction Tools(1)



PCB Connector Covers(88)



PCB Connector Keying(2)

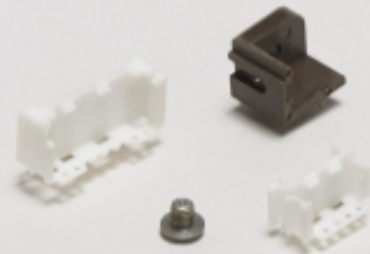

PCB Connector Mounting(1)



PCB Headers & Receptacles(314)



Power Contacts(2)



Rectangular Power Connectors(698)



Standard Rectangular Connectors(337)



Wire-to-Board Connector Contacts(2)

Customers Also Bought



TE Part #1-1622820-8
SMD Power Resistor: 1 Watt, 3520 Series



TE Part #87227-4
08 MODII HDR DRST UNSHRD .100 Series



TE Part #2-1761606-3
IDC LOW PRO HDR 10P VERT LG LAT BLUE



TE Part #350786-1
02P UMNL HDR ASSY 94VO

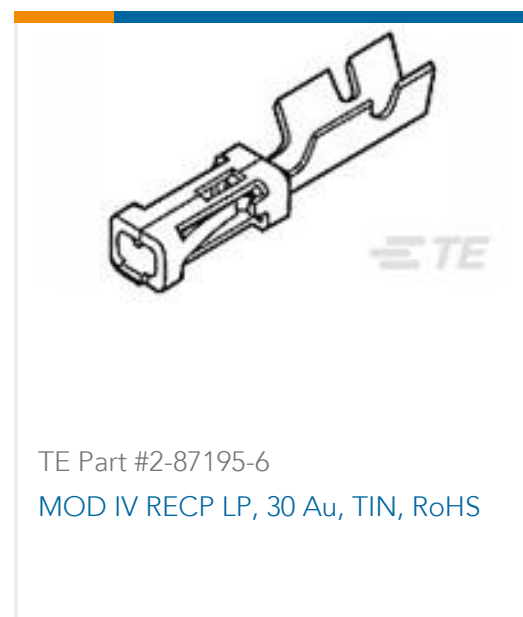

Documents

Product Drawings

[14P MTA156 HDR ASY PO RA FB LF](#)

English

CAD Files

Customer View Model

[ENG_CVM_4-644617-4_J.2d_dxf.zip](#)

English

[3D PDF](#)

English

Customer View Model

[ENG_CVM_4-644617-4_J.3d_igs.zip](#)

English

Customer View Model

[ENG_CVM_4-644617-4_J.3d_stp.zip](#)

English

[3D PDF](#)

3D

Customer View Model

[ENG_CVM_CVM_4-644617-4_D.2d_dxf.zip](#)

English

Customer View Model

[ENG_CVM_CVM_4-644617-4_D.3d_igs.zip](#)

English

Customer View Model

[ENG_CVM_CVM_4-644617-4_D.3d_stp.zip](#)

English

By downloading the CAD file I accept and agree to the [Terms and Conditions](#) of use.

Product Specifications

[Application Specification](#)

English

Product Environmental Compliance

[MD_4-644617-4_09022011023](#)

English

4-644617-4

Rectangular Power Connectors, Header, Plug, Wire-to-Board, 14 Position, 3.96 mm [.156 in] Centerline, Printed Circuit Board, UL 94V-0, MTA 156



[MD_4-644617-4_09022011023](#)

English