

4-1393659-7 ✓ ACTIVE

EUROCARD | Eurocard Type R

TE Internal #: 4-1393659-7

Eurocard Connectors, Plug, Board-to-Board, 64 Position, .1 in [2.54 mm] Centerline, Printed Circuit Board, 2 Row, Vertical, 32 Column, Eurocard Type R

[View on TE.com >](#)



Connectors > PCB Connectors > Backplane Connectors > Eurocard Connectors



Connector & Housing Type: **Plug**

Connector System: **Board-to-Board**

Termination Post & Tail Length: **4.5 mm [.177 in]**

Number of Positions: **64**

Centerline (Pitch): **2.54 mm [.1 in]**

Features

Product Type Features

Connector & Housing Type	Plug
Connector System	Board-to-Board
Connector & Contact Terminates To	Printed Circuit Board
DIN Size	Standard
DIN Level	II

Configuration Features

Number of Power or Coaxial Positions	2
Number of Positions	64
Number of Rows	2
PCB Mount Orientation	Vertical
Number of Columns	32
Number of Signal Positions	64
Rows Loaded	A, C

Body Features



Primary Product Color	Gray
-----------------------	------

Contact Features

Contact Type	Pin
Contact Base Material	Phosphor Bronze
Contact Current Rating (Max)	1.5 A

Termination Features

Termination Method to Printed Circuit Board	Through Hole - Solder
Termination Post & Tail Length	4.5 mm[.177 in]

Mechanical Attachment

Mating Alignment	Without
Panel Mount Feature	Without
PCB Mount Retention	With
PCB Mount Retention Type	Mounting Hole
Connector Mounting Type	Board Mount

Housing Features

Housing Material	Thermoplastic PBT GF
Centerline (Pitch)	2.54 mm[.1 in]

Dimensions

Connector Height	11.51 mm
Row-to-Row Spacing	2.54 mm[.1 in]

Usage Conditions

Operating Temperature Range	-55 – 105 °C[-67 – 221 °F]
-----------------------------	----------------------------

Operation/Application

Shielded	No
Circuit Application	Power & Signal

Industry Standards

UL Flammability Rating	UL 94V-0
------------------------	----------

Packaging Features

Packaging Method	Box
------------------	-----

Product Compliance

[For compliance documentation, visit the product page on TE.com>](#)





EU RoHS Directive 2011/65/EU	Compliant
EU ELV Directive 2000/53/EC	Compliant
China RoHS 2 Directive MIIT Order No 32, 2016	No Restricted Materials Above Threshold
EU REACH Regulation (EC) No. 1907/2006	Current ECHA Candidate List: JUNE 2023 (235) Candidate List Declared Against: JUNE 2023 (235) Does not contain REACH SVHC
Halogen Content	Not Low Halogen - contains Br or Cl > 900 ppm.
Solder Process Capability	Wave solder capable to 240°C

Product Compliance Disclaimer

This information is provided based on reasonable inquiry of our suppliers and represents our current actual knowledge based on the information they provided. This information is subject to change. The part numbers that TE has identified as EU RoHS compliant have a maximum concentration of 0.1% by weight in homogenous materials for lead, hexavalent chromium, mercury, PBB, PBDE, DBP, BBP, DEHP, DIBP, and 0.01% for cadmium, or qualify for an exemption to these limits as defined in the Annexes of Directive 2011/65/EU (RoHS2). Finished electrical and electronic equipment products will be CE marked as required by Directive 2011/65/EU. Components may not be CE marked. Additionally, the part numbers that TE has identified as EU ELV compliant have a maximum concentration of 0.1% by weight in homogenous materials for lead, hexavalent chromium, and mercury, and 0.01% for cadmium, or qualify for an exemption to these limits as defined in the Annexes of Directive 2000/53/EC (ELV). Regarding the REACH Regulation, the information TE provides on SVHC in articles for this part number is based on the latest European Chemicals Agency (ECHA) 'Guidance on requirements for substances in articles' posted at this URL: <https://echa.europa.eu/guidance-documents/guidance-on-reach>

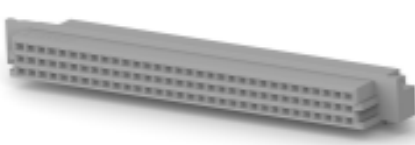
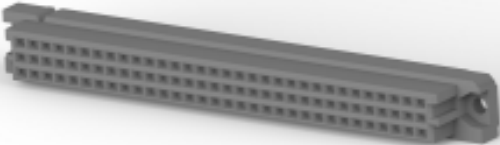
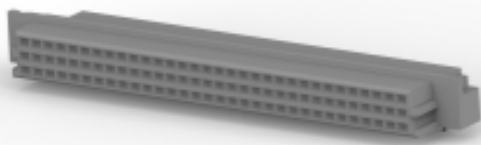
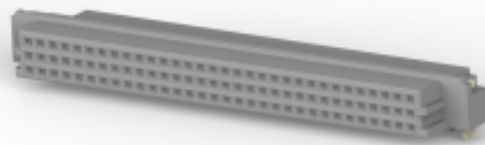
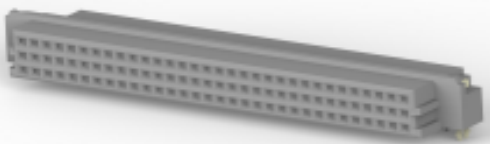
Compatible Parts

 <p>TE Part # 5650870-4 ASSEMBLY,RECEPTACLE,EURO,TYPE</p>	 <p>TE Part # 5650408-5 ASSEMBLY,RECEPTACLE,EURO,TYPE</p>	 <p>TE Part # 5650870-5 ASSEMBLY,RECEPTACLE,EURO,TYPE</p>	 <p>TE Part # 5650897-4 ASSY,RECEPT,EURO,TYPE R,L-FREE, A&C,64/96</p>
 <p>TE Part # 5650897-5 ASSY,RECEPT,EURO,TYPE R,L-FREE, A&C,64/96</p>	 <p>TE Part # 166811-2 RV100 FEM CON 2X32P</p>	 <p>TE Part # 5148296-2 ASSY,RECEPT,EUROCARD,TYPE R,L-FREE,A&B,6</p>	

Also in the Series | Eurocard Type R

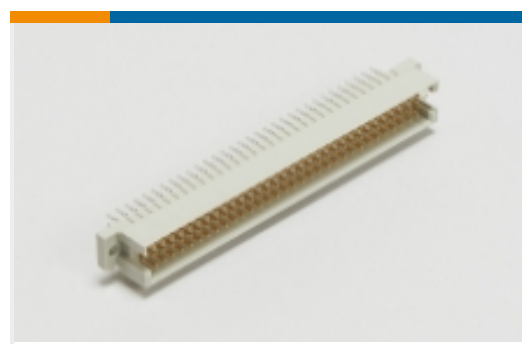

Eurocard Connectors(81)

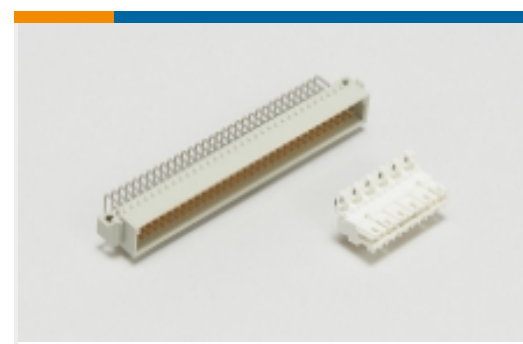

Standard Edge Connectors(1)

Customers Also Bought



TE Part #1-1827864-4
DYNAMIC 1200D REC HSG 8P X
BLACK

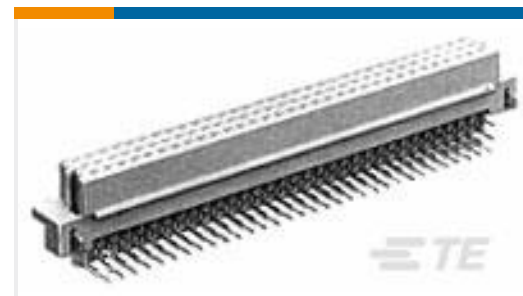

TE Part #5650462-4
ASSY,RECEPTACLE,EUROCARD,TYPE



TE Part #4-794632-2
12P MICRO MNL ASSY,VRT,HDR,LF



TE Part #4-794620-4
14P MICRO MNL ASSY,R/A,HDR,LF

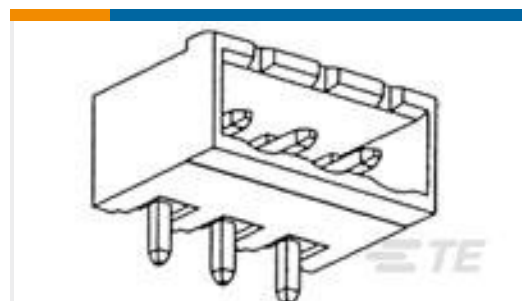

TE Part #1776038-5
5P 5.08 R/A HDR,CLOSED END



TE Part #5745183-2
09 RCPT SP/MS STD



TE Part #1623107-1
CRG0805 1% 120R



TE Part #1623274-1
CRG0805 1% 68R



TE Part #5787394-5
50 50SR R/A RCPT ASSY, LD FREE

Documents

Product Drawings

V42254B1202R963=PC612 MESSERLE

English

CAD Files

3D PDF

3D

Customer View Model

ENG_CVM_CVM_4-1393659-7_B.2d_dxf.zip



English

Customer View Model

[ENG_CVM_CVM_4-1393659-7_B.3d_igs.zip](#)

English

Customer View Model

[ENG_CVM_CVM_4-1393659-7_B.3d_stp.zip](#)

English

By downloading the CAD file I accept and agree to the [Terms and Conditions](#) of use.