



Economy Power

TE Internal #: 4-1123722-3

Housing, Plug, Wire-to-Board, 3 Position, .156 in [3.96 mm]  
Centerline, Crimp, 1 Row, Red, Mating Retention, Wire & Cable,  
Economy Power

[View on TE.com >](#)

Connectors > PCB Connectors > Wire-to-Board Connectors > Wire-to-Board Connector Assemblies & Housings

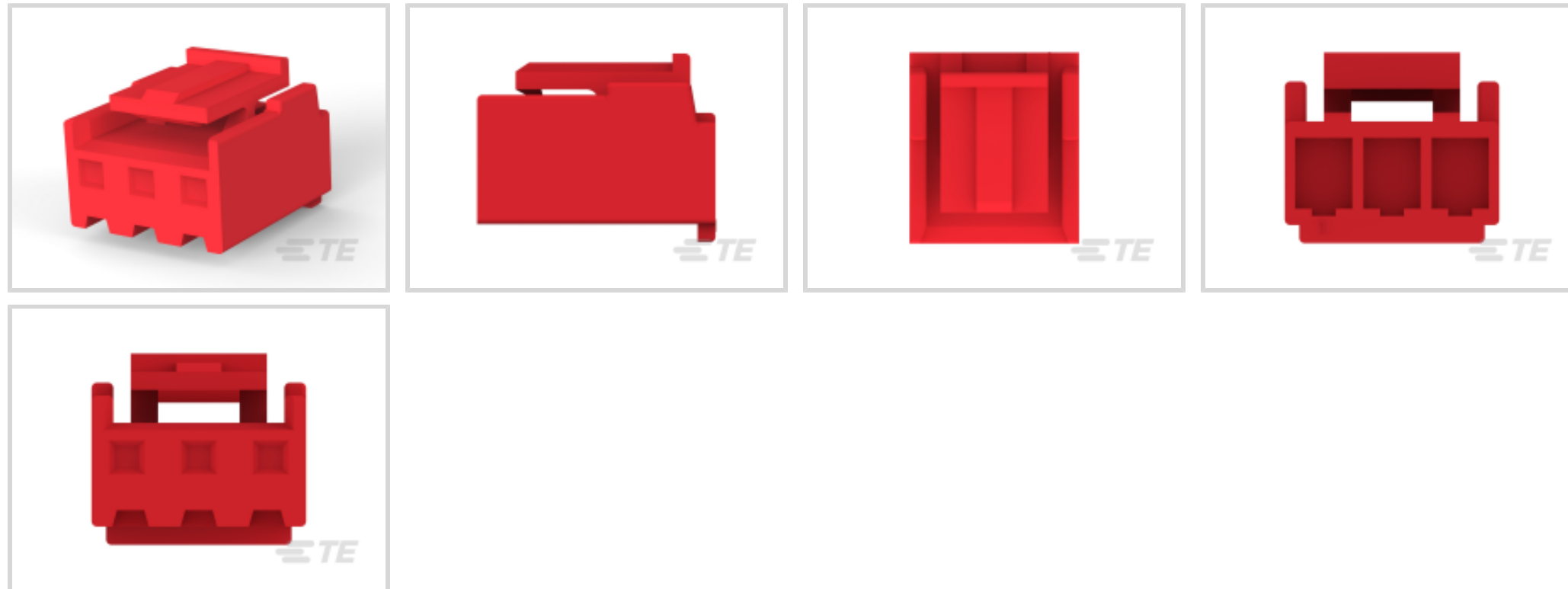

Connector Product Type: **Housing**  
Connector & Housing Type: **Plug**  
Connector System: **Wire-to-Board**  
Number of Positions: **3**  
Centerline (Pitch): **3.96 mm [ .156 in ]**

**Features**

**Product Type Features**

Connector Product Type	Housing
Connector & Housing Type	Plug
Connector System	Wire-to-Board
Sealable	No
Connector & Contact Terminates To	Wire & Cable

**Configuration Features**

Number of Positions	3
Number of Rows	1

**Body Features**

Primary Product Color	Red
-----------------------	-----

**Termination Features**

Termination Method to Wire & Cable	Crimp
------------------------------------	-------

**Mechanical Attachment**

--	--



Mating Retention	With
------------------	------

Connector Mounting Type	Cable Mount (Free-Hanging)
-------------------------	----------------------------

### Housing Features

Centerline (Pitch)	3.96 mm [.156 in]
--------------------	-------------------

### Usage Conditions

Operating Temperature Range	-30 – 105 °C [-22 – 221 °F]
-----------------------------	-----------------------------

### Industry Standards

UL Flammability Rating	UL 94V-0
------------------------	----------

### Packaging Features

Packaging Method	Bag
------------------	-----

## Product Compliance

[For compliance documentation, visit the product page on TE.com>](#)

EU RoHS Directive 2011/65/EU	Compliant
------------------------------	-----------

EU ELV Directive 2000/53/EC	Compliant
-----------------------------	-----------

China RoHS 2 Directive MIIT Order No 32, 2016	No Restricted Materials Above Threshold
---	---

EU REACH Regulation (EC) No. 1907/2006	Current ECHA Candidate List: JUNE 2023 (235) Candidate List Declared Against: JUNE 2023 (235) Does not contain REACH SVHC
--	---

Halogen Content	Low Halogen - Br, Cl, F, I < 900 ppm per homogenous material. Also BFR/CFR/PVC Free
-----------------	---

Solder Process Capability	Not applicable for solder process capability
---------------------------	--

#### Product Compliance Disclaimer

This information is provided based on reasonable inquiry of our suppliers and represents our current actual knowledge based on the information they provided. This information is subject to change. The part numbers that TE has identified as EU RoHS compliant have a maximum concentration of 0.1% by weight in homogenous materials for lead, hexavalent chromium, mercury, PBB, PBDE, DBP, BBP, DEHP, DIBP, and 0.01% for cadmium, or qualify for an exemption to these limits as defined in the Annexes of Directive 2011/65/EU (RoHS2). Finished electrical and electronic equipment products will be CE marked as required by Directive 2011/65/EU. Components may not be CE marked. Additionally, the part numbers that TE has identified as EU ELV compliant have a maximum concentration of 0.1% by weight in homogenous materials for lead, hexavalent chromium, and mercury, and 0.01% for cadmium, or qualify for an exemption to these limits as defined in the Annexes of Directive 2000/53/EC (ELV). Regarding the REACH Regulation, the information TE provides on SVHC in articles for this part number is based on the latest European Chemicals Agency (ECHA) 'Guidance on requirements for substances in articles' posted at this URL: <https://echa.europa.eu/guidance-documents/guidance-on-reach>

## Compatible Parts



Also in the Series | Economy Power



Connector Contacts(1)



Insertion & Extraction Tools(1)

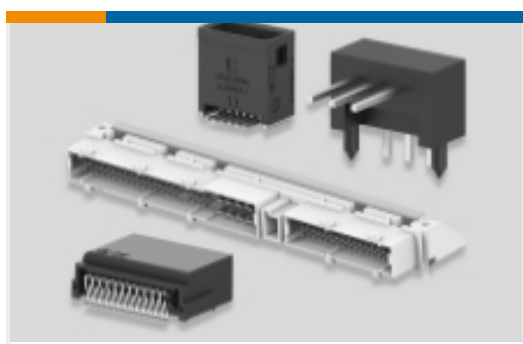

PCB Headers & Receptacles(162)

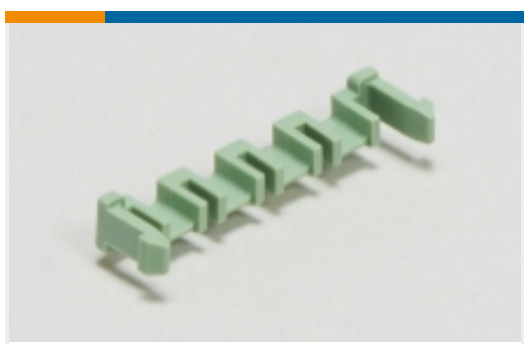

PCB Latches, Locks & Retainers(2)

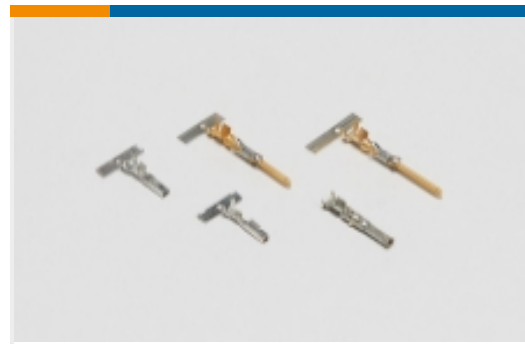

Power Contacts(8)



Rectangular Connector Housings(1)



Rectangular Power Connectors(302)



Wire-to-Board Connector Assemblies & Housings(142)



Wire-to-Board Connector Contacts(6)

## Customers Also Bought



TE Part #499252-3  
026 STRAIN RELIEF A-L RCPT



TE Part #770849-7  
07P SL156 HSG W/LCK RMP & TABS

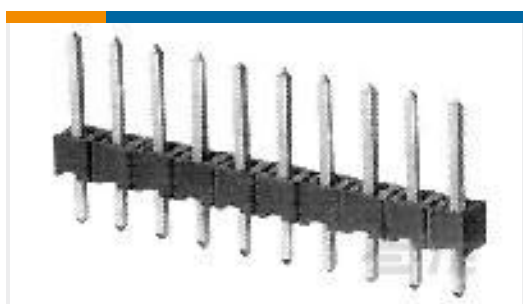

TE Part #826936-3  
3P AMPMODU II STIFT LEI



TE Part #2-1565084-3  
GRACE INERTIA CONNECTOR 3.5 6P

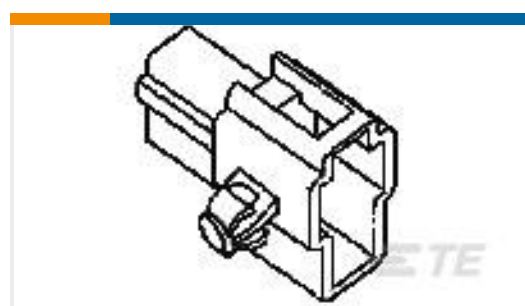

TE Part #172383-2  
FF 250 REC HSG 2P NYLON BLCAK P /M

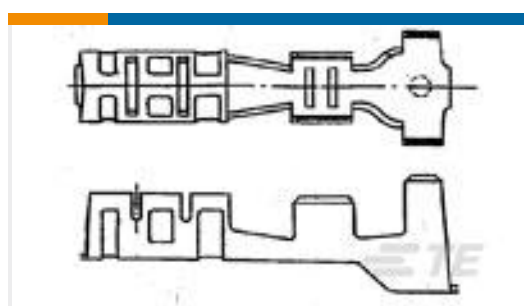

TE Part #175135-1  
CONTACT 22-18 AWG 0.30 X 17.0 PTKLF-5



TE Part #1-1747066-6  
GRACE INERTIA CONN 2.5 PLUG HSG 6P RED



TE Part #5650263-1  
CONN SEC II 3 POS 100C/L



## Documents

### Product Drawings

#### 3.96 EP PLUG HSG 3P(RED)

English

### CAD Files

#### 3D PDF

3D

#### Customer View Model

[ENG\\_CVM\\_CVM\\_4-1123722-3\\_P.2d\\_dxf.zip](#)

English

#### Customer View Model

[ENG\\_CVM\\_CVM\\_4-1123722-3\\_P.3d\\_igs.zip](#)

English

#### Customer View Model

[ENG\\_CVM\\_CVM\\_4-1123722-3\\_P.3d\\_stp.zip](#)

English

By downloading the CAD file I accept and agree to the [Terms and Conditions](#) of use.

### Datasheets & Catalog Pages

#### 1-1773885-9 Economy Power Connectors

English

### Product Specifications

#### Application Specification

English

### Product Environmental Compliance

#### MD\_4-1123722-3\_07252016317\_dmtec

English

#### MD\_4-1123722-3\_07252016317\_dmtec

English

### Instruction Sheets

#### Instruction Sheet (non U.S.)

Japanese

#### Economy Power (EP) Connector



Japanese

---

[Agency Approvals](#)

[UL Report](#)

English