



MQS

TE Internal #: 368382-1

Other Automotive Connector Accessories, TPA, PBT GF, Yellow, -40 – 120 °C [-40 – 248 °F], MQS

[View on TE.com >](#)

Connectors > Automotive Connectors > Automotive Connector Accessories > Other Automotive Connector Accessories



Automotive Connector Accessory Type: **TPA**

Primary Product Material: **PBT GF**

Primary Product Color: **Yellow**

Operating Temperature Range: **-40 – 120 °C [-40 – 248 °F]**

Features

Product Type Features

Automotive Connector Accessory Type	TPA
-------------------------------------	-----

Body Features

Primary Product Material	PBT GF
Primary Product Color	Yellow

Usage Conditions

Operating Temperature Range	-40 – 120 °C[-40 – 248 °F]
-----------------------------	----------------------------

Industry Standards

UL Flammability Rating	UL 94HB
------------------------	---------

Packaging Features

Packaging Quantity	4000
Packaging Method	Box

Other

Serviceable	Yes
-------------	-----

Product Compliance

[For compliance documentation, visit the product page on TE.com>](#)

EU RoHS Directive 2011/65/EU	Compliant
EU ELV Directive 2000/53/EC	Compliant
China RoHS 2 Directive MIIT Order No 32, 2016	No Restricted Materials Above Threshold



EU REACH Regulation (EC) No. 1907/2006

Current ECHA Candidate List: JUNE 2023 (235)

Candidate List Declared Against: JUNE 2023 (235)

Does not contain REACH SVHC

Halogen Content

Low Halogen - Br, Cl, F, I < 900 ppm per homogenous material. Also BFR/CFR/PVC Free

Solder Process Capability

Not applicable for solder process capability

Product Compliance Disclaimer

This information is provided based on reasonable inquiry of our suppliers and represents our current actual knowledge based on the information they provided. This information is subject to change. The part numbers that TE has identified as EU RoHS compliant have a maximum concentration of 0.1% by weight in homogenous materials for lead, hexavalent chromium, mercury, PBB, PBDE, DBP, BBP, DEHP, DIBP, and 0.01% for cadmium, or qualify for an exemption to these limits as defined in the Annexes of Directive 2011/65/EU (RoHS2). Finished electrical and electronic equipment products will be CE marked as required by Directive 2011/65/EU. Components may not be CE marked. Additionally, the part numbers that TE has identified as EU ELV compliant have a maximum concentration of 0.1% by weight in homogenous materials for lead, hexavalent chromium, and mercury, and 0.01% for cadmium, or qualify for an exemption to these limits as defined in the Annexes of Directive 2000/53/EC (ELV). Regarding the REACH Regulation, the information TE provides on SVHC in articles for this part number is based on the latest European Chemicals Agency (ECHA) 'Guidance on requirements for substances in articles' posted at this URL: <https://echa.europa.eu/guidance-documents/guidance-on-reach>

Compatible Parts



TE Part # 1473244-1
MQS REC 81P ASSY



TE Part # 1473244-3
MQS/JPT 81POS PLUG ASSY



TE Part # 1-2219100-2
ECU 81P HDR ASSY

Also in the Series | MQS



Automotive Connector Caps & Covers (138)



Automotive Connector EMC Shielding (3)

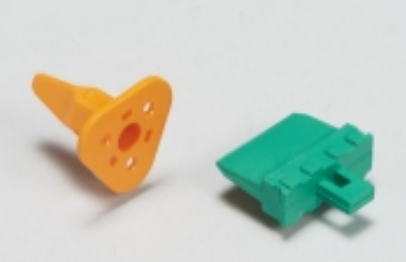

Automotive Connector Locks & Position Assurance(30)

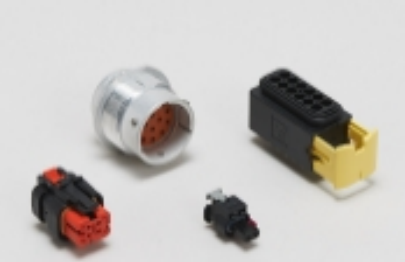

Automotive Housings(507)

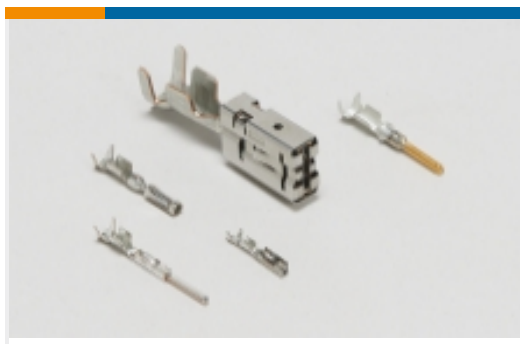

Automotive Terminals(104)



Connector Seals & Cavity Plugs(27)



Insertion & Extraction Tools(42)



Other Automotive Connector Accessories(14)

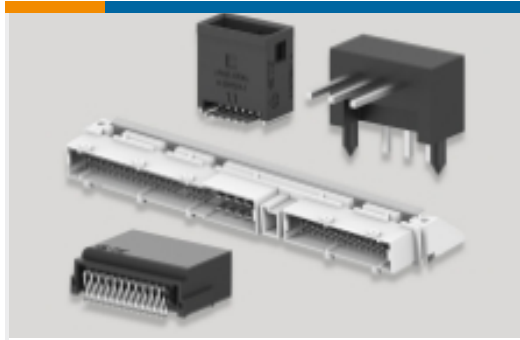

PCB Headers & Receptacles(214)

Customers Also Bought



TE Part #368376-1
81P REC HSG ASSY(SIEMENS) BLK



TE Part #964282-2
JPT A REC 2.8 Contact SWS Sn



TE Part #5-968221-1
MQS, RECEPTACLE AND TAB

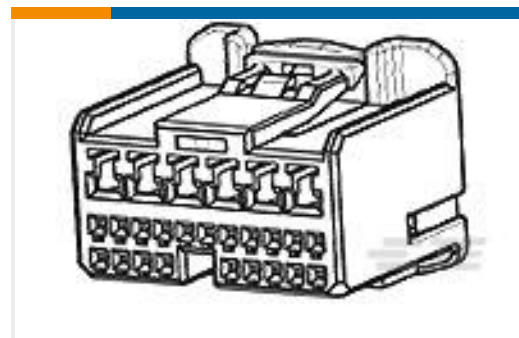

TE Part #1318758-2
025/090 ECU PLUG HSG ASSY 30P



TE Part #1473244-3
MQS/JPT 81POS PLUG ASSY

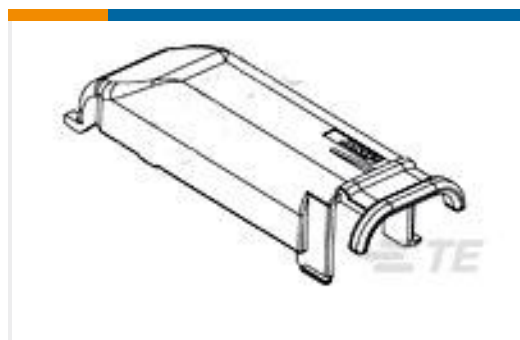

TE Part #368389-1
COVER HSG FOR 81P(SIEMENS)

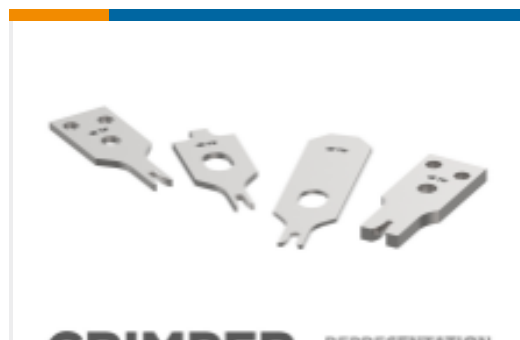

TE Part #6-2119582-3
CRIMPER, INSULATION F PREMIUM

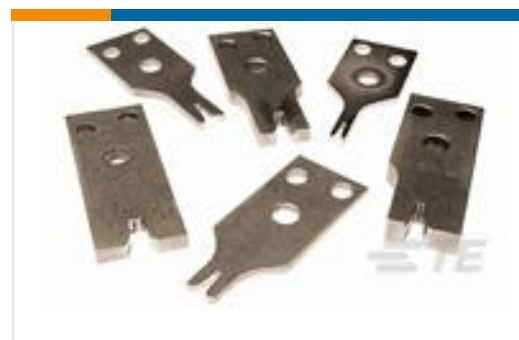

TE Part #8-2119784-1
CRIMPER INSULATION O PREMIUM

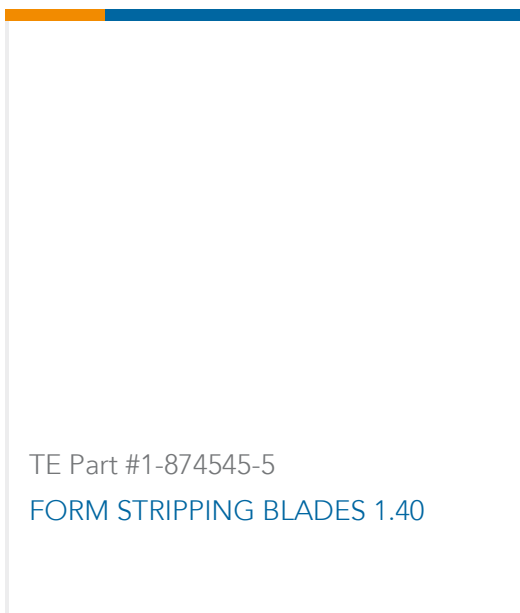

TE Part #1-874545-5
FORM STRIPPING BLADES 1.40

Documents



Product Drawings

MQS RETAINER HSG FOR 81P

English

CAD Files

Customer View Model

[ENG_CVM_368382-1_O.3d_igs.zip](#)

English

Customer View Model

[ENG_CVM_368382-1_O.3d_stp.zip](#)

English

Customer View Model

[ENG_CVM_368382-1_O.2d_dxf.zip](#)

English

3D PDF

English

By downloading the CAD file I accept and agree to the [Terms and Conditions](#) of use.

Product Specifications

Product Specification

Japanese

MQS CLEAN BODY PLUG ASSY 81P & 40P

Japanese

MQS CLEAN BODY PLUG ASSY 81P & 40P

Japanese

Product Specification

English

Instruction Sheets

Instruction Sheet (non U.S.)

English

Instruction Sheet (non U.S.)

Japanese