

368269-1 ✓ ACTIVE

## Multilock Connector System

TE Internal #: 368269-1

Other Automotive Connector Accessories, Mounting Clip, PA,  
Natural, -40 – 120 °C [-40 – 248 °F], Multilock Connector System

[View on TE.com >](#)



Connectors > Automotive Connectors > Automotive Connector Accessories > Other Automotive Connector Accessories

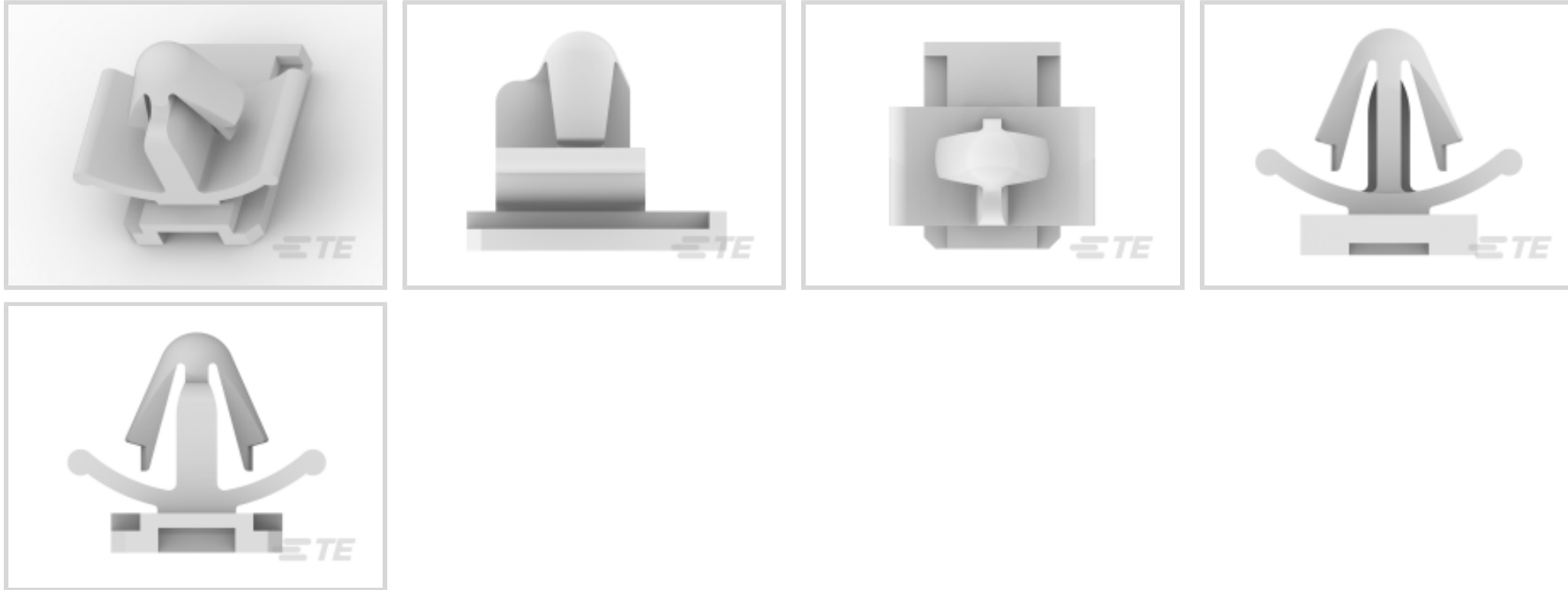

Automotive Connector Accessory Type: **Mounting Clip**

Primary Product Material: **PA**

Primary Product Color: **Natural**

Operating Temperature Range: **-40 – 120 °C [-40 – 248 °F]**

### Features

#### Product Type Features

Automotive Connector Accessory Type	Mounting Clip
-------------------------------------	---------------

#### Body Features

Primary Product Material	PA
Primary Product Color	Natural

#### Usage Conditions

Operating Temperature Range	-40 – 120 °C[-40 – 248 °F]
-----------------------------	----------------------------

#### Industry Standards

UL Flammability Rating	UL 94HB
------------------------	---------

#### Packaging Features

Packaging Quantity	1000
Packaging Method	Bag

#### Other

Serviceable	Yes
-------------	-----

### Product Compliance







[For compliance documentation, visit the product page on TE.com>](#)

EU RoHS Directive 2011/65/EU	Compliant
EU ELV Directive 2000/53/EC	Compliant
China RoHS 2 Directive MIIT Order No 32, 2016	No Restricted Materials Above Threshold
EU REACH Regulation (EC) No. 1907/2006	Current ECHA Candidate List: JUNE 2023 (235) Candidate List Declared Against: JUNE 2023 (235) Does not contain REACH SVHC
Halogen Content	Low Halogen - Br, Cl, F, I < 900 ppm per homogenous material. Also BFR/CFR/PVC Free
Solder Process Capability	Not applicable for solder process capability

Product Compliance Disclaimer

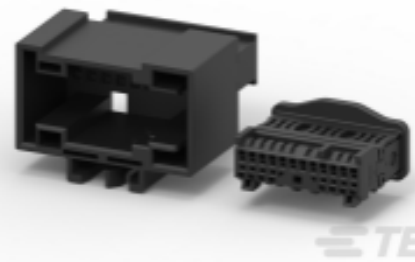
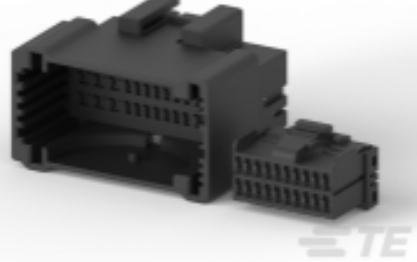
This information is provided based on reasonable inquiry of our suppliers and represents our current actual knowledge based on the information they provided. This information is subject to change. The part numbers that TE has identified as EU RoHS compliant have a maximum concentration of 0.1% by weight in homogenous materials for lead, hexavalent chromium, mercury, PBB, PBDE, DBP, BBP, DEHP, DIBP, and 0.01% for cadmium, or qualify for an exemption to these limits as defined in the Annexes of Directive 2011/65/EU (RoHS2). Finished electrical and electronic equipment products will be CE marked as required by Directive 2011/65/EU. Components may not be CE marked. Additionally, the part numbers that TE has identified as EU ELV compliant have a maximum concentration of 0.1% by weight in homogenous materials for lead, hexavalent chromium, and mercury, and 0.01% for cadmium, or qualify for an exemption to these limits as defined in the Annexes of Directive 2000/53/EC (ELV). Regarding the REACH Regulation, the information TE provides on SVHC in articles for this part number is based on the latest European Chemicals Agency (ECHA) 'Guidance on requirements for substances in articles' posted at this URL: <https://echa.europa.eu/guidance-documents/guidance-on-reach>

## Compatible Parts

 <p>TE Part # CAT-M8793-CH8172 MQS, CONNECTOR HOUSING</p>	 <p>TE Part # CAT-M9194-CH8172 MULTILOCK, CONNECTOR HOUSING</p>	 <p>TE Part # 2297911-1 12 WAY IN-LINE TAB PLUG ASSY</p>	 <p>TE Part # 2304887-1 16POS, HYBRID, TAB HSG ASSY, SLD, COD 1</p>
 <p>TE Part # 1-936586-2 TPMS 3P PLUG ASSY</p>	 <p>TE Part # 936586-2 TPMS 3P PLUG ASSY</p>		



## Also in the Series | Multilock Connector System



Automotive Connector Caps & Covers (17)



Automotive Connector EMC Shielding (1)

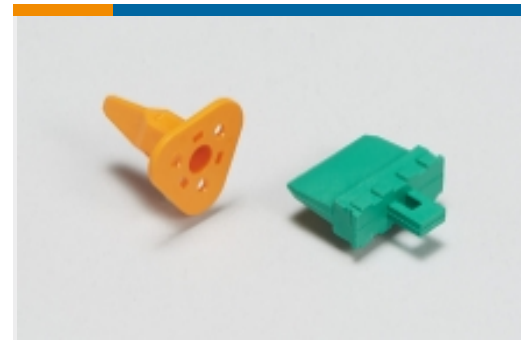

Automotive Connector Locks & Position Assurance(2)



Automotive Housings(603)

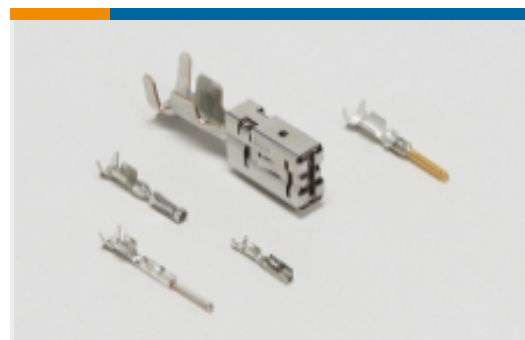

Automotive Terminals(141)



Connector Seals & Cavity Plugs(2)



Insertion & Extraction Tools(6)



Other Automotive Connector Accessories(14)

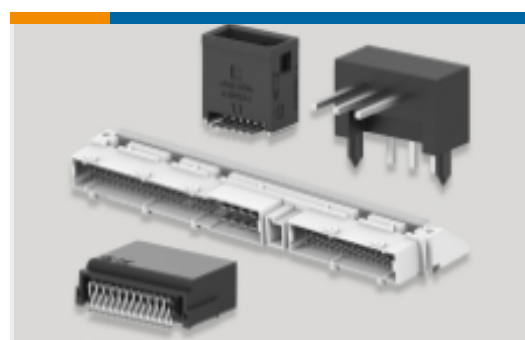

PCB Headers & Receptacles(142)

## Customers Also Bought

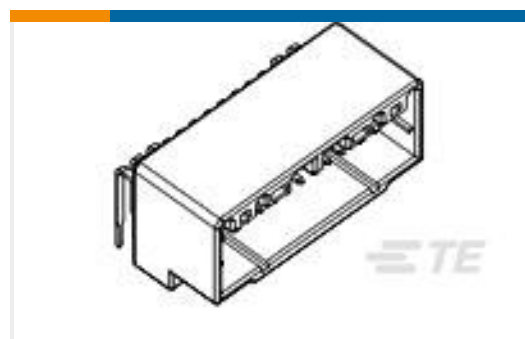

TE Part #178811-1  
040/070 HYBRID CAP ASSY 26P



TE Part #1897214-1  
MCP 6.3 2P PLUG ASSY



TE Part #85011-1  
RUBBER PLUG FOR SEALED CONN.



TE Part #1743757-2  
SPT SEALED 3P CAP HSG

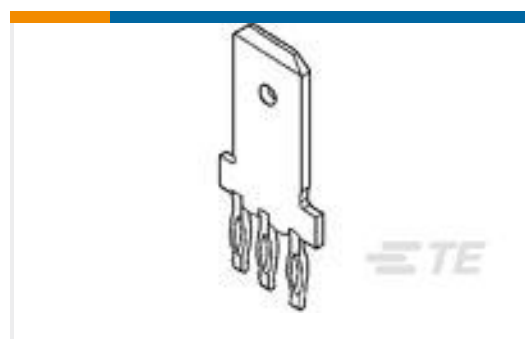

TE Part #216842-4  
250 FASTON,TAB,PCB,SPPB



TE Part #968043-1  
SINGLE WIRE SEAL



TE Part #2188270-1  
020 28P PLUG ASSY



TE Part #7-2355198-5  
HVP800 2P HEADER ASSY

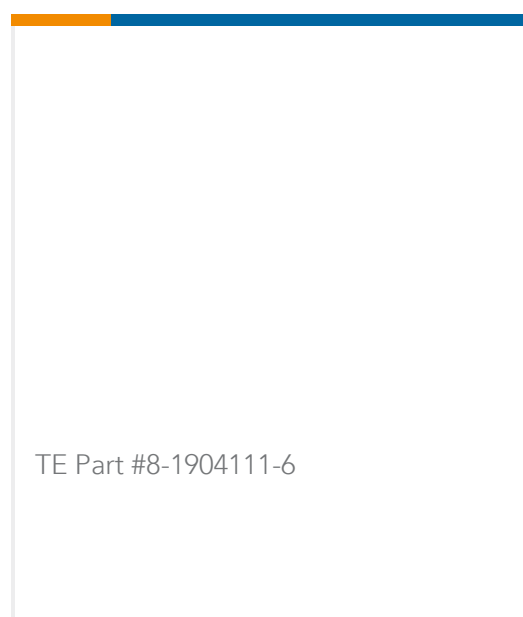
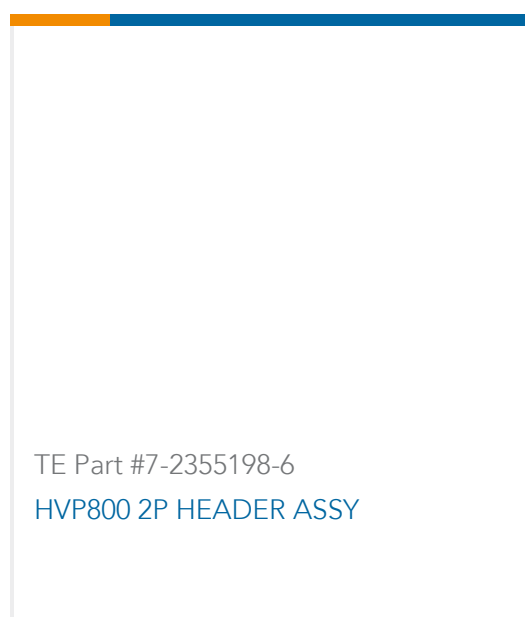

## Documents

### Product Drawings

[CLIP FOR 090 II MLC\(KEY HOLE\)](#)

English

### CAD Files

[3D PDF](#)

English

**Customer View Model**

[ENG\\_CVM\\_368269-1\\_A.2d\\_dxf.zip](#)

English

**Customer View Model**

[ENG\\_CVM\\_368269-1\\_A.3d\\_igs.zip](#)

English

**Customer View Model**

[ENG\\_CVM\\_368269-1\\_A.3d\\_stp.zip](#)

English

By downloading the CAD file I accept and agree to the [Terms and Conditions](#) of use.

### Instruction Sheets

[Instruction Sheet \(U.S.\)](#)

English