



Positive Lock | Positive Lock 110

TE Internal #: 353250-2

Quick Disconnects, Receptacle, 20 – 16 AWG Wire Size, .51 – 1.31 mm² Wire Size, Mating Tab Width 2.8 mm [.11 in], Straight, Positive Lock 110

[View on TE.com >](#)

Terminals & Splices > Quick Disconnects



Quick Disconnect Terminal Type: **Receptacle**

Wire Size: **.51 – 1.31 mm²**

Mating Tab Width: **2.8 mm [.11 in]**

Terminal Orientation: **Straight**

Features

Configuration Features

Connection Capacity	Single
Compatible With Wire & Cable Type	Discrete Wire

Contact Features

Quick Disconnect Terminal Type	Receptacle
Mating Tab Width	2.8 mm [.11 in]
Terminal Orientation	Straight
Contact Base Material	Phosphor Bronze
Terminal Plating Material	Pre-Tin
Crimp Type	F-Crimp
Barrel Type	Open

Termination Features

Product Terminates To	Wire & Cable
-----------------------	--------------

Mechanical Attachment

Wire Insulation Support	With
-------------------------	------

Dimensions

Terminal Material Thickness	.25 mm[.01 in]
Compatible Insulation Diameter Range	2.01 – 3.1 mm[.079 – .12 in]
Wire Size	.51 – 1.31 mm ²

Usage Conditions

Insulation Option	Uninsulated
Operating Temperature Range	-40 – 110 °C[-40 – 230 °F]

Packaging Features

Packaging Quantity	4000
Packaging Method	Strip/Reel

Product Compliance

[For compliance documentation, visit the product page on TE.com>](#)

EU RoHS Directive 2011/65/EU	Compliant
EU ELV Directive 2000/53/EC	Compliant
China RoHS 2 Directive MIIT Order No 32, 2016	No Restricted Materials Above Threshold
EU REACH Regulation (EC) No. 1907/2006	Current ECHA Candidate List: JUNE 2023 (235) Candidate List Declared Against: JUNE 2023 (235) Does not contain REACH SVHC
Halogen Content	Low Halogen - Br, Cl, F, I < 900 ppm per homogenous material. Also BFR/CFR/PVC Free
Solder Process Capability	Not applicable for solder process capability

Product Compliance Disclaimer

This information is provided based on reasonable inquiry of our suppliers and represents our current actual knowledge based on the information they provided. This information is subject to change. The part numbers that TE has identified as EU RoHS compliant have a maximum concentration of 0.1% by weight in homogenous materials for lead, hexavalent chromium, mercury, PBB, PBDE, DBP, BBP, DEHP, DIBP, and 0.01% for cadmium, or qualify for an exemption to these limits as defined in the Annexes of Directive 2011/65/EU (RoHS2). Finished electrical and electronic equipment products will be CE marked as required by Directive 2011/65/EU. Components may not be CE marked. Additionally, the part numbers that TE has identified as EU ELV compliant have a maximum concentration of 0.1% by weight in homogenous materials for lead, hexavalent chromium, and mercury, and 0.01% for cadmium, or qualify for an exemption to these limits as defined in the Annexes of Directive 2000/53/EC (ELV). Regarding the REACH Regulation, the information TE provides on SVHC in articles for this part number is based on the latest European Chemicals Agency (ECHA) 'Guidance on requirements for substances in articles' posted at this URL: <https://echa.europa.eu/guidance-documents/guidance-on-reach>

Compatible Parts



TE Part # 2305570-1
Strip Terminal Cutter-Side Feed-No Crimp



TE Part # 353253-1
PL EX 110 (2.8 MM) HOUSING RECEPTACLE



TE Part # 353251-1
PL EX 110 (2.8 MM) HOUSING RECEPTACLE



TE Part # 353255-7
110 HSG. PL EX REC. 7.6mm 3P RED



TE Part # 353255-1
110 HSG. PL EX REC. 7.6mm 3P NAT



TE Part # 2151117-1
OCEAN_2.0_Applicator-S-080F130F



TE Part # 2151117-2
OCEAN_2.0_Applicator-S-080F130F



TE Part # 7-2151117-1
OCEAN_2.0_Applicator-S-080F130F



TE Part # 7-2151117-2
OCEAN_2.0_Applicator-S-080F130F



TE Part # 7-2151117-7
OCEAN_2.0_SPARE_PART_KIT-080F130F



TE Part # 2-2151117-1
OCEAN_2.0_Applicator-S-080F130F



TE Part # 2468539-1
110 PL EX HSG.,REC.,8MM,2P, NATURAL

Also in the Series | Positive Lock 110

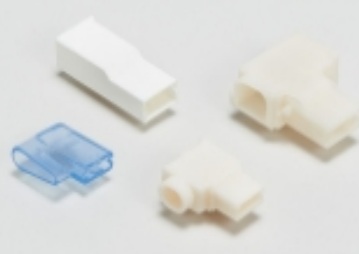

Crimp Terminal Housings(12)



Insertion & Extraction Tools(1)

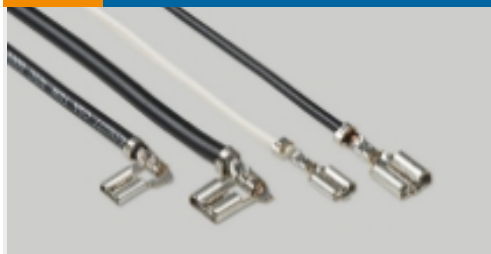

Quick Disconnects(8)

Customers Also Bought



TE Part #917765-1
2.5 SIGNAL D/LOCK TAB CONT. M



TE Part #1-1565087-2
GRACE INERTIA CONNECTOR 3.5 4P

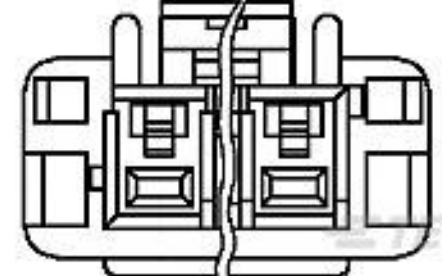

TE Part #1-1376388-2
5MM POWER KEY 2P PLUG HSG RED



TE Part #1612335-1
GRACE INERTIA 3.5 TAB CONTACT (M)

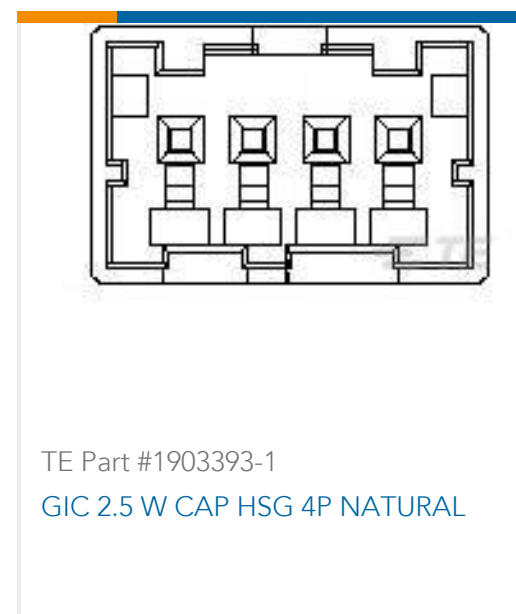
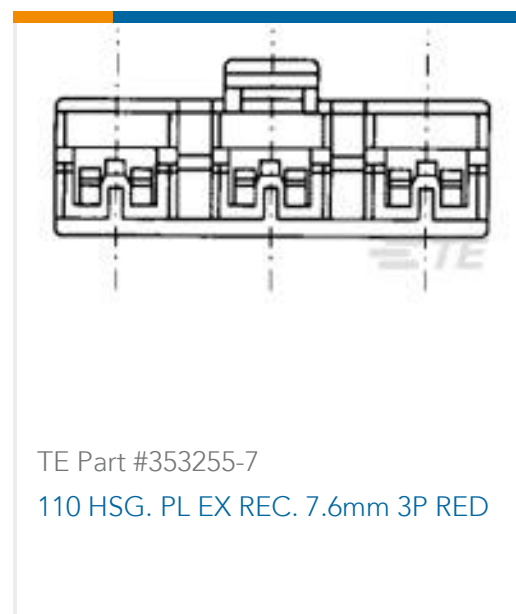
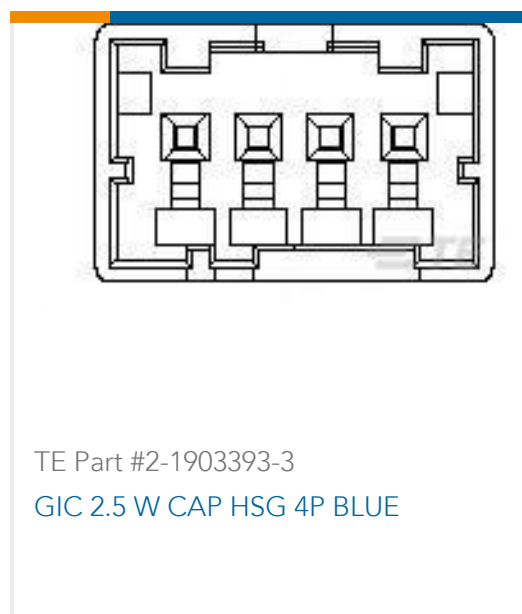

Documents

Product Drawings

[110 PL EX REC. 20-16AWG PTPHBZ](#)

Japanese

CAD Files

[3D PDF](#)

3D

Customer View Model

[ENG_CVM_CVM_353250-2_F.2d_dxf.zip](#)

English

Customer View Model

[ENG_CVM_CVM_353250-2_F.3d_igs.zip](#)

English

Customer View Model

[ENG_CVM_CVM_353250-2_F.3d_stp.zip](#)

English

By downloading the CAD file I accept and agree to the [Terms and Conditions](#) of use.

Product Specifications

[Application Specification](#)

English

[110 Series Positive Lock EX-III Contact](#)

Japanese

[Application Specification](#)

Japanese

[110 Series Positive Lock EX-III Contact](#)

English

Product Environmental Compliance

[TE Material Declaration](#)

English

Instruction Sheets

[Instruction Sheet \(non U.S.\)](#)

English

Japanese

353250-2

Quick Disconnects, Receptacle, 20 – 16 AWG Wire Size, .51 – 1.31 mm² Wire Size,
Mating Tab Width 2.8 mm [.11 in], Straight, Positive Lock 110



English