



Commercial Pin and Socket Connectors

TE Internal #: 350628-6

Power Contacts, Contact, 250 VAC, Gold, 24 – 18 AWG Wire Size, .2 – .82 mm<sup>2</sup> Wire Size, Wire & Cable, Crimp, Commercial Pin and Socket Connectors

[View on TE.com >](#)

Connectors > Power Connectors > Power Contacts

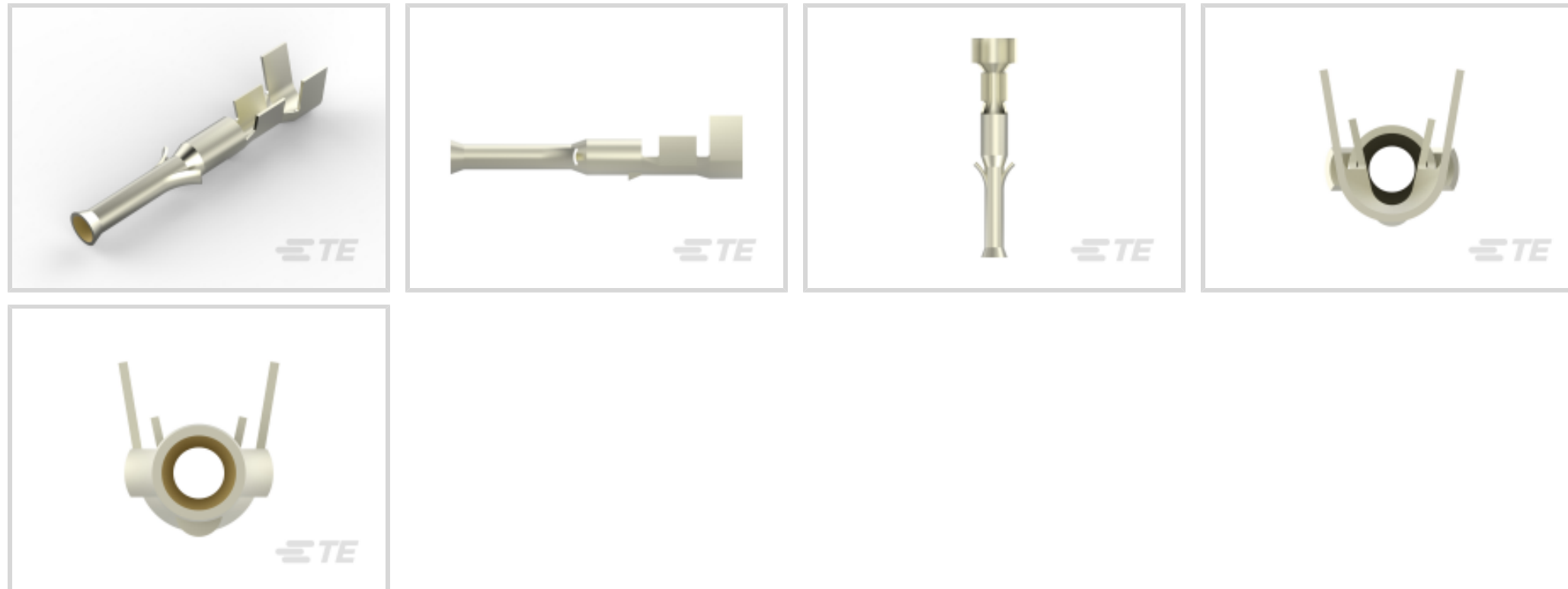

Power Contact Type: **Contact**

Operating Voltage: **250 VAC**

Contact Mating Area Plating Material: **Gold**

Wire Size: **.2 – .82 mm<sup>2</sup>**

**Features**

**Product Type Features**

Power Contact Type	Contact
Connector & Contact Terminates To	Wire & Cable

**Electrical Characteristics**

Operating Voltage	250 VAC
-------------------	---------

**Contact Features**

Contact Fabrication	Stamped & Formed
Contact Mating Area Plating Material	Gold
Contact Current Rating (Max)	9 A
Contact Type	Socket
Contact Retention Within Housing	With
Mating Pin Diameter	1.57 mm[.062 in]
Contact Base Material	Phosphor Bronze
Contact Mating Area Plating Material Thickness	.8 μm[31.49 μin]
Wire Contact Termination Area Plating Thickness	.76 μm[30 μin]
Wire Contact Termination Area Plating Material	Gold



Wire Contact Termination Area Plating Material Finish	Bright
Contact Orientation	Straight
Contact Underplating Material	Nickel
Contact Underplating Material Thickness	.8 µm[31.49 µin]

### Termination Features

Termination Method to Wire & Cable	Crimp
------------------------------------	-------

### Mechanical Attachment

Wire Insulation Support	Without
-------------------------	---------

### Dimensions

Wire Size	.2 – .82 mm <sup>2</sup>
Compatible Insulation Diameter Range	1.27 – 2.79 mm[.05 – .11 in]

### Usage Conditions

Operating Temperature Range	-55 – 105 °C[-67 – 221 °F]
-----------------------------	----------------------------

### Operation/Application

Circuit Application	Power
---------------------	-------

### Industry Standards

CSA Rating	LR 7189
UL Rating	Recognized
Agency/Standard	CSA, UL

### Packaging Features

Packaging Quantity	6500
Packaging Method	Reel

### Product Compliance

[For compliance documentation, visit the product page on TE.com>](#)

EU RoHS Directive 2011/65/EU	Compliant
EU ELV Directive 2000/53/EC	Compliant
China RoHS 2 Directive MIIT Order No 32, 2016	No Restricted Materials Above Threshold
EU REACH Regulation (EC) No. 1907/2006	Current ECHA Candidate List: JUNE 2023 (235) Candidate List Declared Against: JUNE 2023 (235) Does not contain REACH SVHC

Halogen Content

Low Halogen - Br, Cl, F, I < 900 ppm per homogenous material. Also BFR/CFR/PVC Free

Solder Process Capability

Not applicable for solder process capability

Product Compliance Disclaimer

This information is provided based on reasonable inquiry of our suppliers and represents our current actual knowledge based on the information they provided. This information is subject to change. The part numbers that TE has identified as EU RoHS compliant have a maximum concentration of 0.1% by weight in homogenous materials for lead, hexavalent chromium, mercury, PBB, PBDE, DBP, BBP, DEHP, DIBP, and 0.01% for cadmium, or qualify for an exemption to these limits as defined in the Annexes of Directive 2011/65/EU (RoHS2). Finished electrical and electronic equipment products will be CE marked as required by Directive 2011/65/EU. Components may not be CE marked. Additionally, the part numbers that TE has identified as EU ELV compliant have a maximum concentration of 0.1% by weight in homogenous materials for lead, hexavalent chromium, and mercury, and 0.01% for cadmium, or qualify for an exemption to these limits as defined in the Annexes of Directive 2000/53/EC (ELV). Regarding the REACH Regulation, the information TE provides on SVHC in articles for this part number is based on the latest European Chemicals Agency (ECHA) 'Guidance on requirements for substances in articles' posted at this URL: <https://echa.europa.eu/guidance-documents/guidance-on-reach>

## Compatible Parts



TE Part # 770334-1  
04P .062 COMM P&S PLUG



TE Part # 770277-1  
01P .062 COMM P&S RECPT



TE Part # 770335-1  
04P .062 COMM P&S RECPT



TE Part # 770333-1  
03P .062 COMM P&S RECPT



TE Part # 770340-1  
02P .062 COMM P&S PLUG



TE Part # 770343-1  
02P .062 COMM P&S RECPT



TE Part # 770331-1  
03P .062 COMM P&S PLUG



TE Part # 770342-1  
02P .062 COMM P&S RECPT



TE Part # 770274-1  
04P .062 COMM P&S RECPT



TE Part # 770275-1  
04P .062 COMM P&S PLUG



TE Part # 770341-1  
02P .062 COMM P&S PLUG



TE Part # 770355-1  
06P .062 COMM P&S PLUG



## Also in the Series | Commercial Pin and Socket Connectors

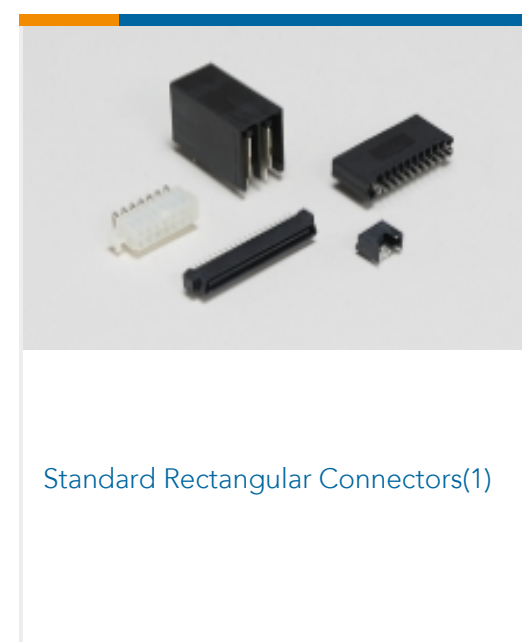
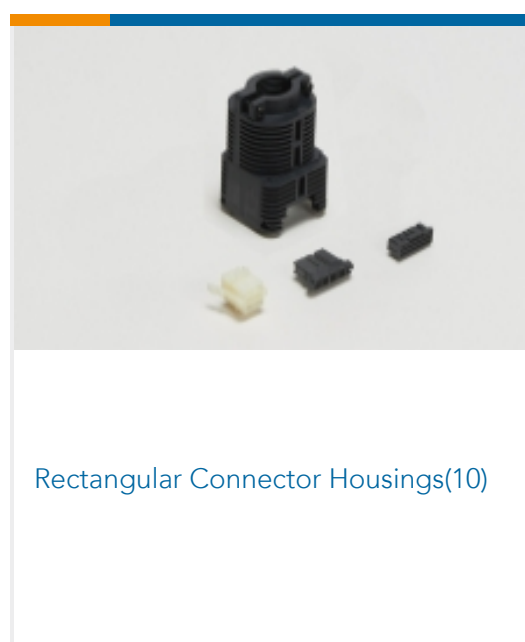
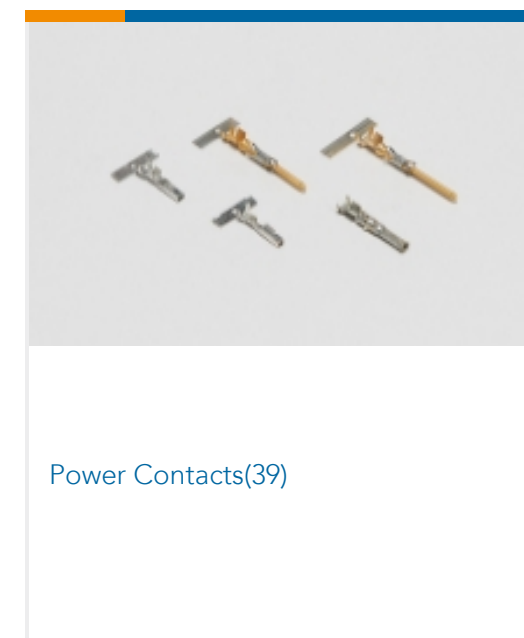
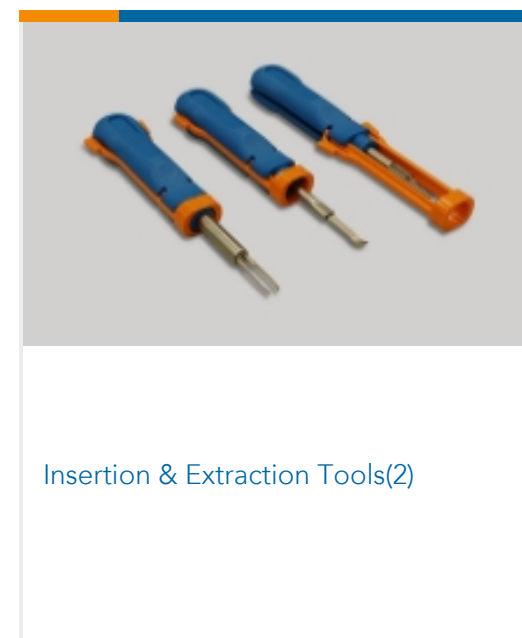
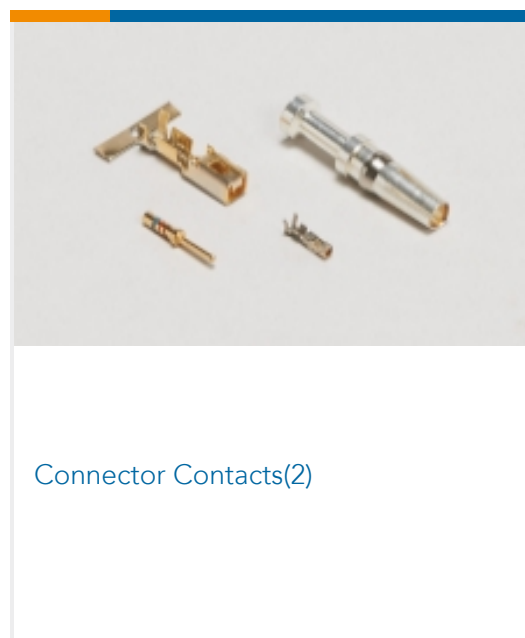

## Customers Also Bought





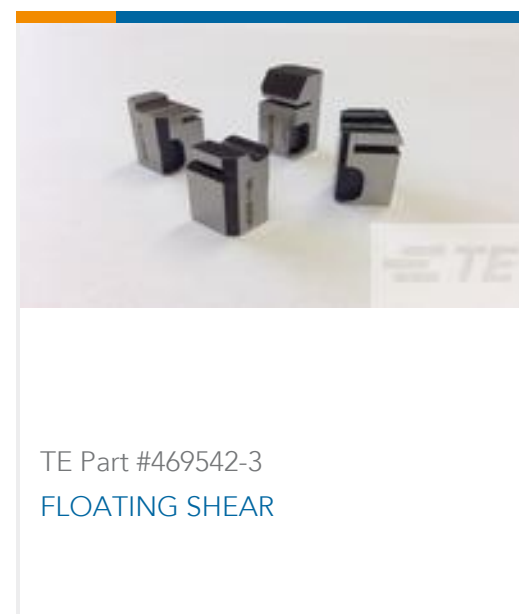
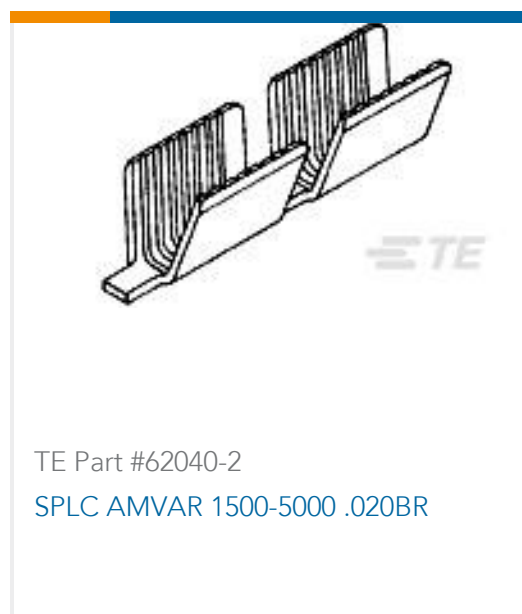

## Documents

### Product Drawings

[.062 COMM P&S SOK AUNI/PHBZ](#)

English

### CAD Files

[3D PDF](#)

English

Customer View Model

[ENG\\_CVM\\_350628-6\\_S.2d\\_dxf.zip](#)

English

Customer View Model

[ENG\\_CVM\\_350628-6\\_S.3d\\_igs.zip](#)

English

Customer View Model

[ENG\\_CVM\\_350628-6\\_S.3d\\_stp.zip](#)

English

[3D PDF](#)

3D

Customer View Model

[ENG\\_CVM\\_CVM\\_350628-6\\_AR.2d\\_dxf.zip](#)

English

Customer View Model

[ENG\\_CVM\\_CVM\\_350628-6\\_AR.3d\\_igs.zip](#)

English

Customer View Model

[ENG\\_CVM\\_CVM\\_350628-6\\_AR.3d\\_stp.zip](#)

English



By downloading the CAD file I accept and agree to the [Terms and Conditions](#) of use.

## Datasheets & Catalog Pages

[SOFT\\_SHELL\\_PIN\\_AND\\_SOCKET\\_CONNECTORS\\_CATALOG](#)

English

## Product Specifications

[Application Specification](#)

English