

34835 ✓ ACTIVE

PLASTI-GRIP

TE Internal #: 34835

Closed Ring Tongue Terminal, 12 – 10 AWG, M2.5 / #4 Stud Size,
3.02 mm [.119 in] Stud Diameter, Closed Barrel, Straight, Tin,
PLASTI-GRIP

[View on TE.com >](#)



Terminals & Splices > Ring Terminals

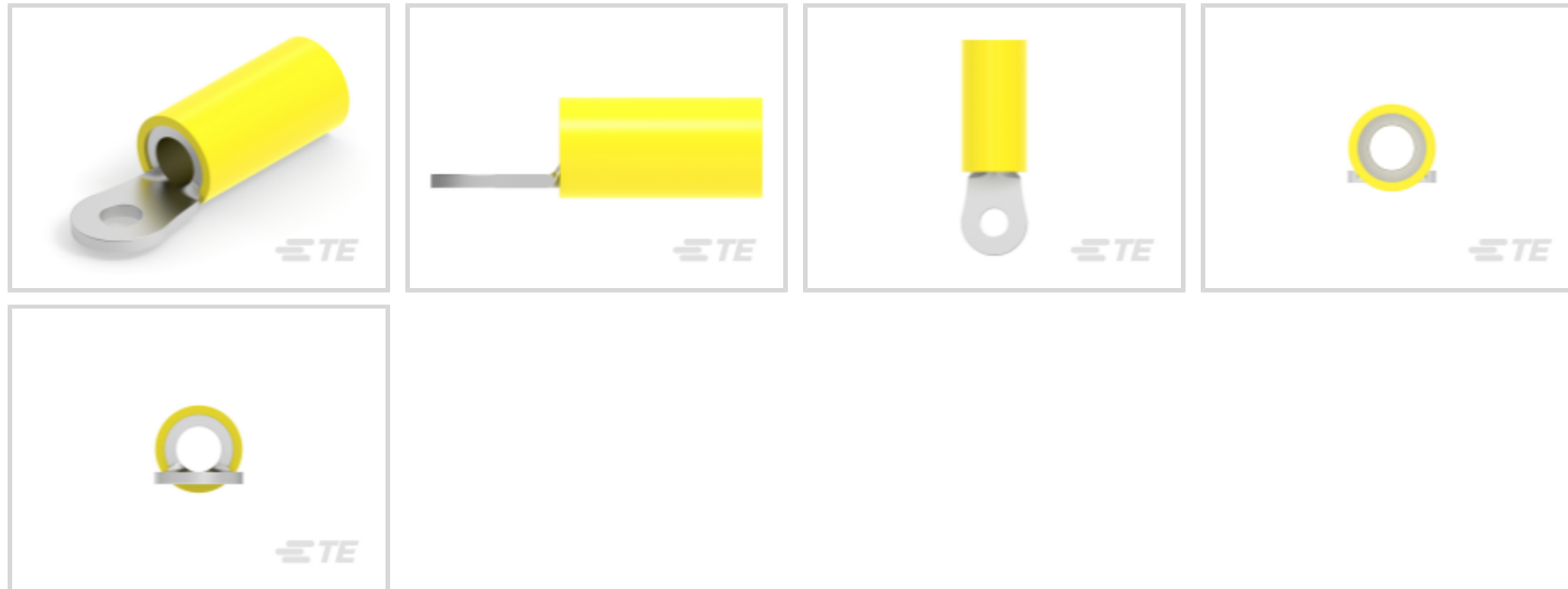

Ring Terminal Product Type: Closed Ring Tongue Terminal

Wire Size: 5180 – 13100 CMA

Stud Size: #4, M2.5

Features

Product Type Features

Ring Terminal Product Type	Closed Ring Tongue Terminal
Stud Size	#4, M2.5
Sealable	No
Wire Insulation Support Retention Type	Insulation Support

Configuration Features

Number of Holes	1
-----------------	---

Electrical Characteristics

Voltage Rating	600 V
----------------	-------

Body Features

Product Weight	.395 g
----------------	--------

Contact Features

Barrel Type	Closed
Terminal Orientation	Straight
Terminal Plating Material	Tin

Mechanical Attachment



Wire Insulation Support	With
-------------------------	------

Dimensions

Wire Size	5180 – 13100 CMA
Stud Diameter	3.02 mm [.119 in]
Tongue Thickness	1 mm [.042 in]
Product Length	24.21 mm [.95 in]
Compatible Insulation Diameter (Max)	6.35 mm [.25 in]
Compatible Insulation Diameter Range	3.81 – 6.35 mm [.15 – .25 in]

Usage Conditions

Insulation Option	Partially Insulated
Operating Temperature Range	105 °C [221 °F]

Operation/Application

Compatible With Wire Base Material	Copper
Compatible With Wire Plating Material	Tin

Industry Standards

Government Qualified Terminal	No
-------------------------------	----

Packaging Features

Packaging Quantity	500
Packaging Method	Loose Piece

Product Compliance













[For compliance documentation, visit the product page on TE.com>](#)

EU RoHS Directive 2011/65/EU	Compliant
EU ELV Directive 2000/53/EC	Compliant
China RoHS 2 Directive MIIT Order No 32, 2016	No Restricted Materials Above Threshold
EU REACH Regulation (EC) No. 1907/2006	Current ECHA Candidate List: JUNE 2023 (235) Candidate List Declared Against: JUNE 2023 (235) Does not contain REACH SVHC
Halogen Content	Not Low Halogen - contains Br or Cl > 900 ppm.
Solder Process Capability	Not applicable for solder process capability

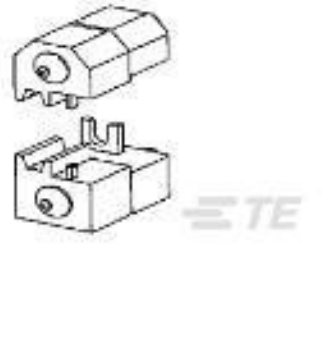
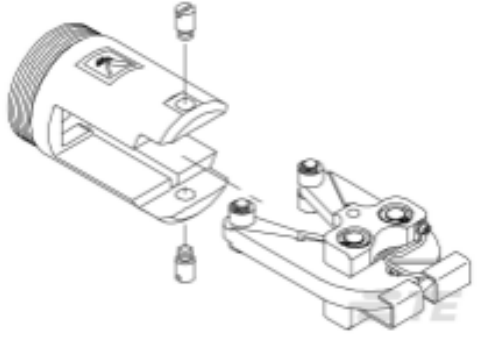
Product Compliance Disclaimer

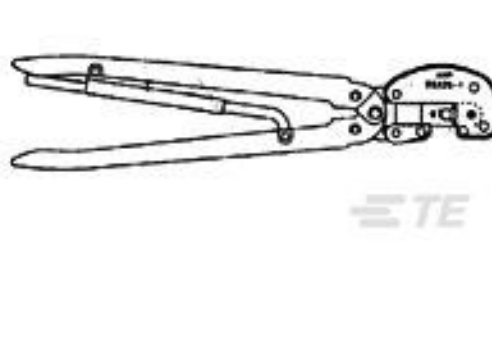
This information is provided based on reasonable inquiry of our suppliers and represents our current actual knowledge based on the information they provided. This information is subject to change. The part numbers that TE has identified as EU RoHS compliant have a maximum concentration of 0.1% by weight in homogenous materials for lead, hexavalent chromium, mercury, PBB, PBDE, DBP, BBP, DEHP, DIBP, and 0.01% for cadmium, or qualify for an exemption to these limits as defined in the Annexes of Directive 2011/65/EU (RoHS2). Finished electrical and electronic equipment products will be CE marked as required by Directive 2011/65/EU. Components may not be CE marked. Additionally, the part numbers that TE has identified as EU ELV compliant have a maximum concentration of 0.1% by weight in homogenous materials for lead, hexavalent chromium, and mercury, and 0.01% for cadmium, or qualify for an exemption to these limits as defined in the Annexes of Directive 2000/53/EC (ELV). Regarding the REACH Regulation, the information TE provides on SVHC in articles for this part number is based on the latest European Chemicals Agency (ECHA) 'Guidance on requirements for substances in articles' posted at this URL: <https://echa.europa.eu/guidance-documents/guidance-on-reach>

Compatible Parts

 <p>TE Part # 59824-1 TETRA-CRIMP PIDG PG FASTON 22-10 ASSY</p>	 <p>TE Part # 59239-4 HHHT PIDG PG 12-10 ASSY</p>	 <p>TE Part # 58423-1 DIE, RBY IS9252</p>	 <p>TE Part # 58433-3 PRO CR ASSY, RBY IS9252</p>
 <p>TE Part # 539691-2 ERGO DIE R.B.Y</p>	 <p>TE Part # 525692 HHHT PIDG PG 12-10 ASSY</p>	 <p>TE Part # 2063030-1 SDE DIESET, RBY, UL</p>	 <p>TE Part # 47808-6 DIES PIDG 12-10 DIE SET</p>
 <p>TE Part # 679300-1 1210 PIDG CRIMP HEAD</p>	 <p>TE Part # 169400 CERTI-LOK FRAME W/O DIES</p>	 <p>TE Part # 1-59239-4 HHHT PIDG 16-10 HEAD</p>	 <p>TE Part # 1SET191001R0000 CRIMP-HT</p>
 <p>TE Part # 1SET191002R0000 TET CRIMP-HT</p>	 <p>TE Part # 169404 CERTI-LOK DIE</p>		

Also in the Series | PLASTI-GRIP



Compression Connectors(3)



Crimp Wire Pins, Tabs & Ferrules(25)



Ring Terminals(333)

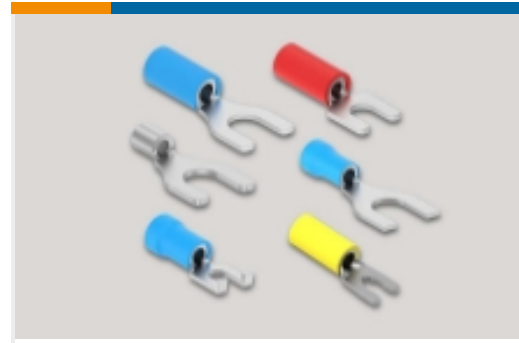

Spade Terminals(198)



Splices(50)

Customers Also Bought

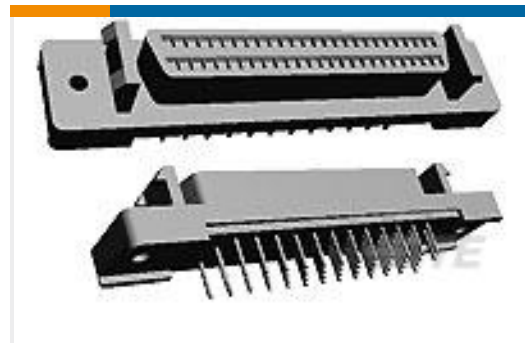

TE Part #5749721-5
50 50SR VERT RCPT ASSY

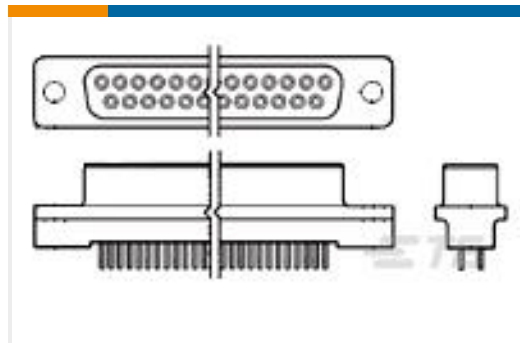

TE Part #5745078-4
HD-20 RCPT 25P VERT FFSCRLK

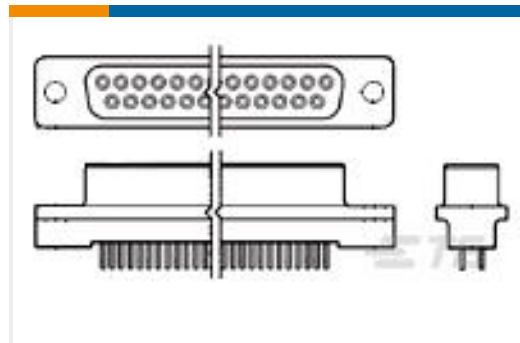

TE Part #5745077-4
HD-20 RCPT 15P VERT FFSCRLK



TE Part #5745074-1
HD-20 PLUG 37P VERT FFSCRLK

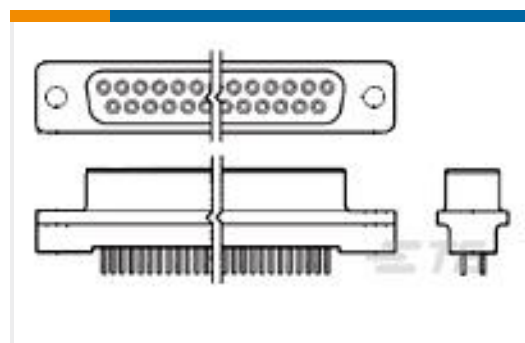

TE Part #5745079-6
HD-20 RCPT 37P VERT FFSCRLK



TE Part #342183-1
12-10 F.E.P.G. RING TONGUE 3BA



TE Part #1-1410999-2
MULTIGIG RT GUIDE PIN, 9MM 2.60

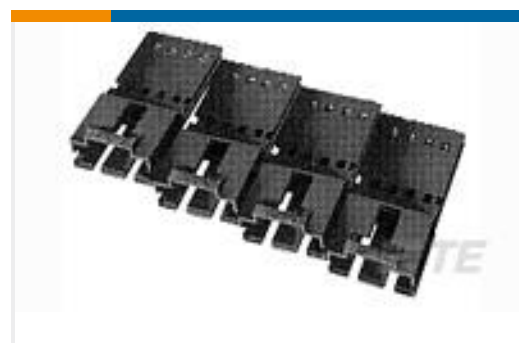

TE Part #103653-8
09 MTE SHRD PIN HSG SR LATCH



TE Part #YDIV40E13-35PNC009
RECP ASSY



TE Part #YDIV40E11-35PNC009
RECP ASSY



Documents

Product Drawings

[TERMINAL,PG R 12-10 4](#)

English

CAD Files

[3D PDF](#)

3D

Customer View Model

[ENG_CVM_CVM_34835_Y.2d_dxf.zip](#)

English

Customer View Model

[ENG_CVM_CVM_34835_Y.3d_igs.zip](#)

English

Customer View Model

[ENG_CVM_CVM_34835_Y.3d_stp.zip](#)

English

By downloading the CAD file I accept and agree to the [Terms and Conditions](#) of use.

Product Specifications

[Application Specification](#)

English

Agency Approvals

[UL Report](#)

English

[UL Report](#)

English

[UL Report](#)

English

[UL Report](#)

English