

34806 ✓ ACTIVE

PIDG

TE Internal #: 34806

Closed Ring Tongue Terminal, 16 – 14 AWG, M6 Stud Size, 6.35 mm [.265 in] Stud Diameter, Closed Barrel, Straight, Tin, Partially Insulated, PIDG

[View on TE.com >](#)



Terminals & Splices > Ring Terminals > PIDG Ring Tongue Terminals

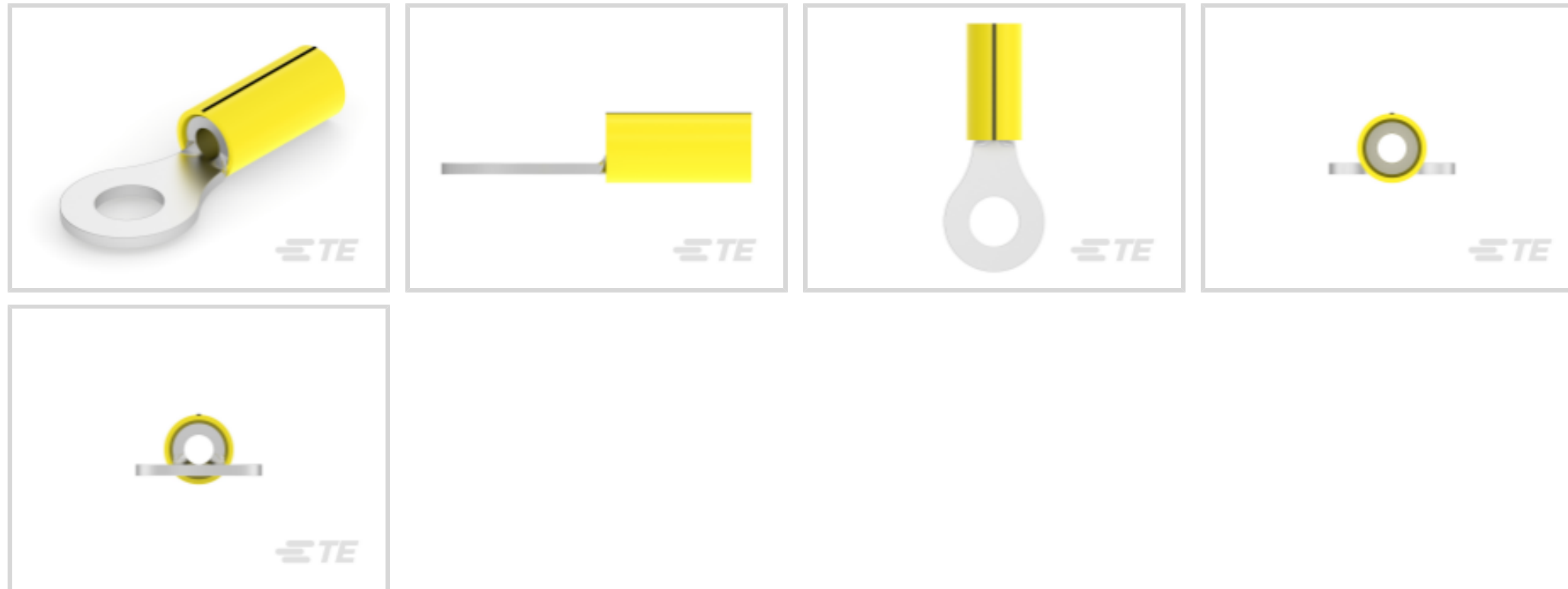

Ring Terminal Product Type: Closed Ring Tongue Terminal

Wire Size: 2050 – 5180 CMA

Stud Size: M6

[All PIDG Ring Tongue Terminals \(418\)](#)

Features

Product Type Features

Terminal Features	Heavy Duty
Ring Terminal Product Type	Closed Ring Tongue Terminal
Stud Size	M6
Sealable	No
Wire Insulation Support Retention Type	Insulation Support

Configuration Features

Number of Holes	1
-----------------	---

Electrical Characteristics

Voltage Rating	300 V
----------------	-------

Body Features

Product Weight	5.547 g
Stripe Color	Black

Contact Features

--	--



Barrel Type	Closed
Terminal Orientation	Straight
Terminal Plating Material	Tin

Mechanical Attachment

Wire Insulation Support	With
-------------------------	------

Dimensions

Wire Size	2050 – 5180 CMA
Stud Diameter	6.35 mm [.265 in]
Tongue Thickness	1.22 mm [.05 in]
Product Length	32.92 mm [1.3 in]
Compatible Insulation Diameter (Max)	6.35 mm [.25 in]
Compatible Insulation Diameter Range	3.81 – 6.35 mm [.15 – .25 in]

Usage Conditions

Insulation Option	Partially Insulated
Operating Temperature Range	105 °C [221 °F]

Operation/Application

Compatible With Wire Base Material	Copper
Compatible With Wire Plating Material	Tin

Industry Standards

Government Qualified Terminal	No
-------------------------------	----

Packaging Features

Packaging Quantity	500
Packaging Method	Loose Piece

Other

Terminals & Splices Comment	Heavy Duty for extra mechanical strength
-----------------------------	--

Product Compliance

[For compliance documentation, visit the product page on TE.com>](#)

EU RoHS Directive 2011/65/EU	Compliant
EU ELV Directive 2000/53/EC	Compliant
China RoHS 2 Directive MIIT Order No 32, 2016	No Restricted Materials Above Threshold
EU REACH Regulation (EC) No. 1907/2006	



Current ECHA Candidate List: JUNE 2023 (235)
 Candidate List Declared Against: JUNE 2023 (235)
 Does not contain REACH SVHC

Halogen Content
 Low Halogen - Br, Cl, F, I < 900 ppm per homogenous material. Also BFR/CFR/PVC Free

Solder Process Capability
 Not applicable for solder process capability

Product Compliance Disclaimer

This information is provided based on reasonable inquiry of our suppliers and represents our current actual knowledge based on the information they provided. This information is subject to change. The part numbers that TE has identified as EU RoHS compliant have a maximum concentration of 0.1% by weight in homogenous materials for lead, hexavalent chromium, mercury, PBB, PBDE, DBP, BBP, DEHP, DIBP, and 0.01% for cadmium, or qualify for an exemption to these limits as defined in the Annexes of Directive 2011/65/EU (RoHS2). Finished electrical and electronic equipment products will be CE marked as required by Directive 2011/65/EU. Components may not be CE marked. Additionally, the part numbers that TE has identified as EU ELV compliant have a maximum concentration of 0.1% by weight in homogenous materials for lead, hexavalent chromium, and mercury, and 0.01% for cadmium, or qualify for an exemption to these limits as defined in the Annexes of Directive 2000/53/EC (ELV). Regarding the REACH Regulation, the information TE provides on SVHC in articles for this part number is based on the latest European Chemicals Agency (ECHA) 'Guidance on requirements for substances in articles' posted at this URL: <https://echa.europa.eu/guidance-documents/guidance-on-reach>

Compatible Parts



TE Part # 59824-1
 TETRA-CRIMP PIDG PG FASTON 22-10 ASSY



TE Part # 59239-4
 HHHT PIDG PG 12-10 ASSY



TE Part # 58423-1
 DIE, RBY IS9252



TE Part # 58433-3
 PRO CR ASSY, RBY IS9252



TE Part # 539691-2
 ERGO DIE R.B.Y



TE Part # 525692
 HHHT PIDG PG 12-10 ASSY



TE Part # 2063030-1
 SDE DIESET, RBY, UL



TE Part # 47808-6
 DIES PIDG 12-10 DIE SET



Also in the Series | PIDG

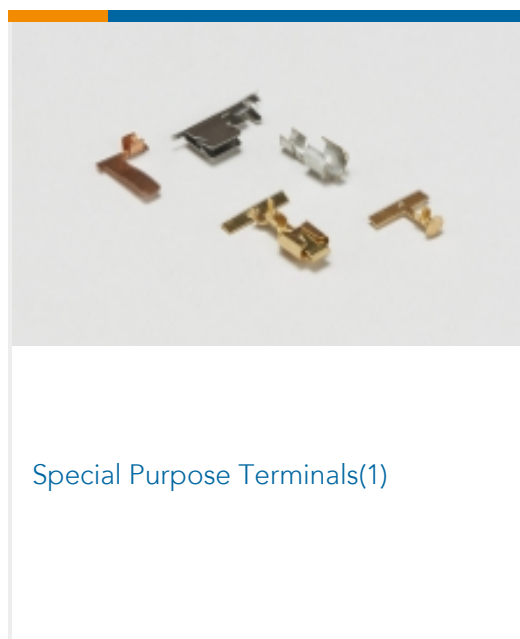
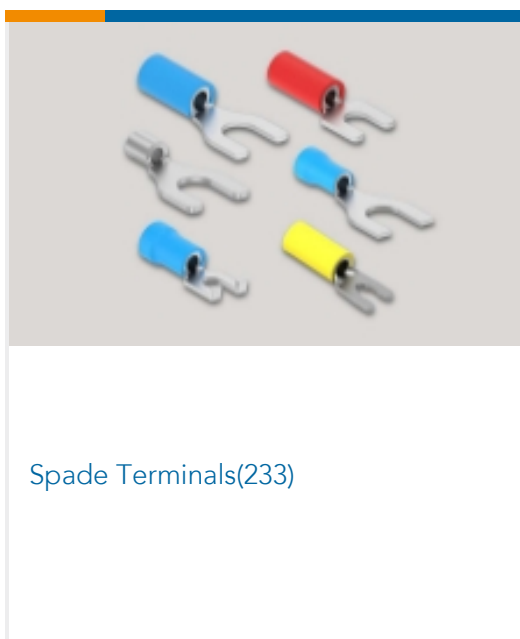
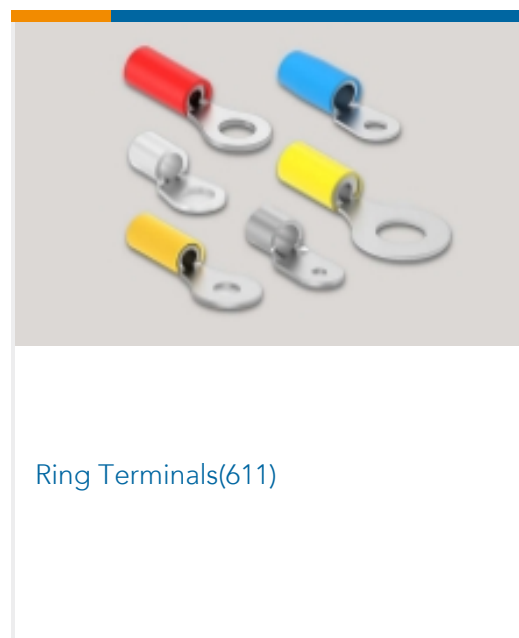
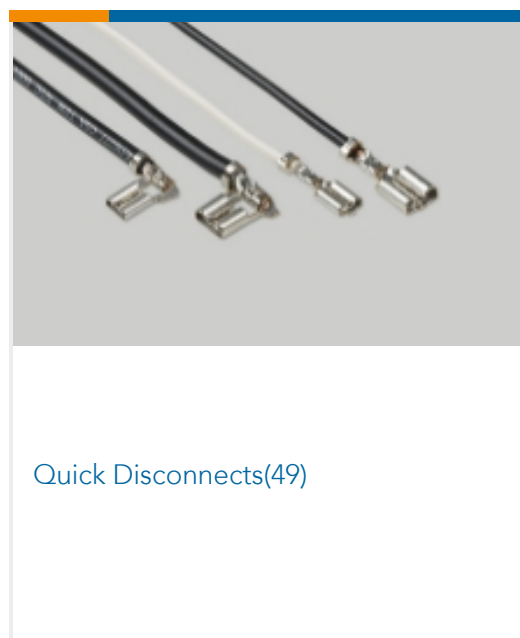
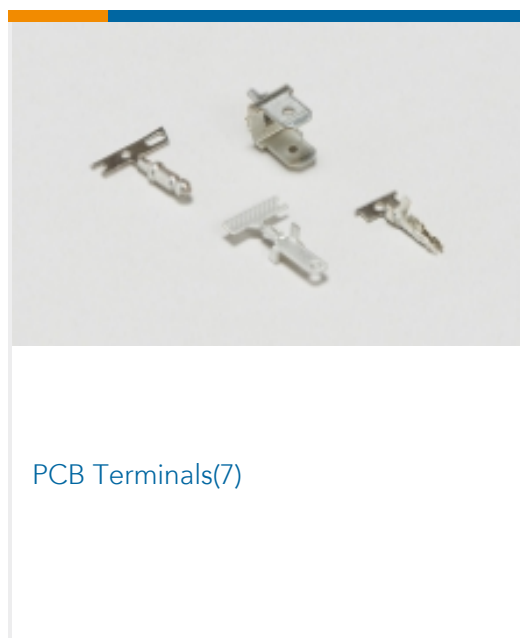
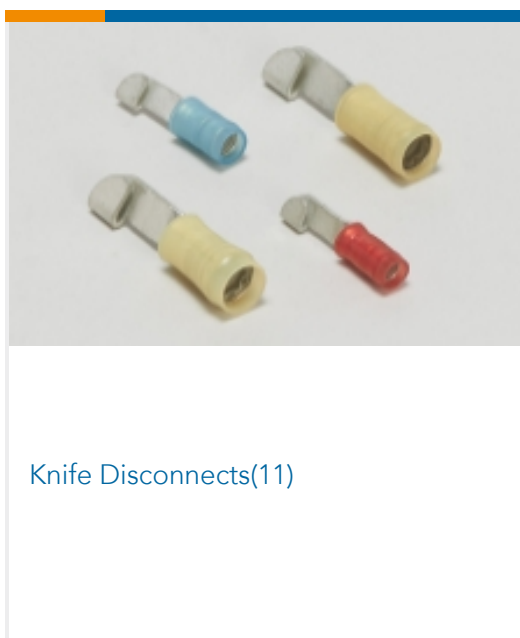
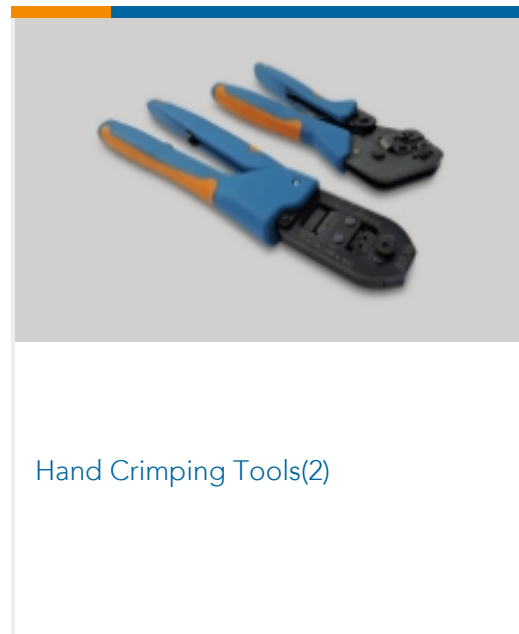
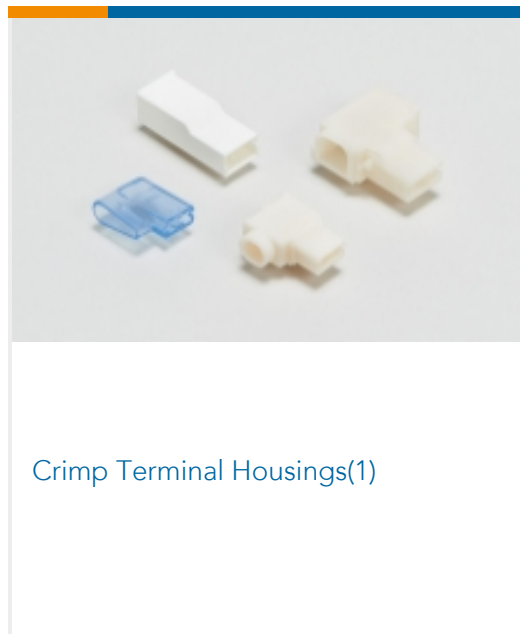

Customers Also Bought

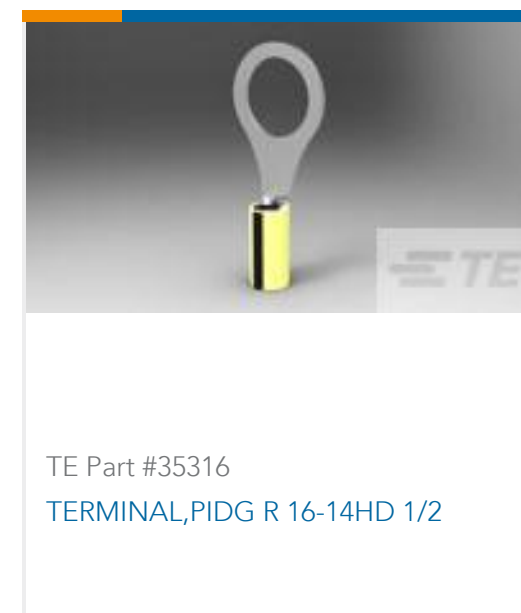
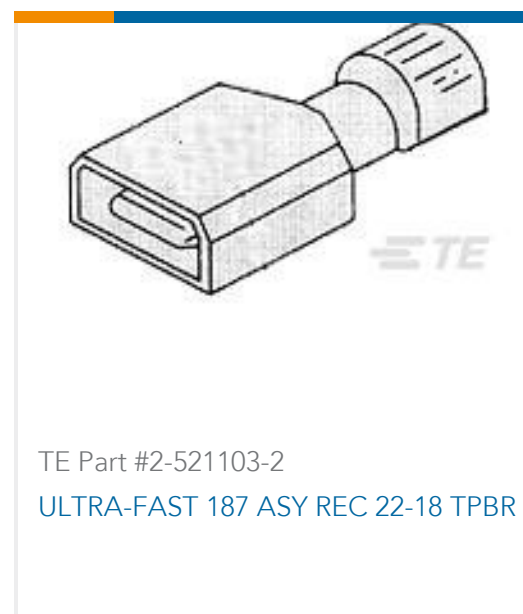

Documents

Product Drawings

[TERMINAL,PIDG R 16-14HD 1/4](#)

English

CAD Files

[3D PDF](#)

3D

Customer View Model

[ENG_CVM_CVM_34806_S.2d_dxf.zip](#)

English

Customer View Model

[ENG_CVM_CVM_34806_S.3d_igs.zip](#)

English

Customer View Model

[ENG_CVM_CVM_34806_S.3d_stp.zip](#)

English

By downloading the CAD file I accept and agree to the [Terms and Conditions](#) of use.

Product Specifications



Application Specification

English

Product Environmental Compliance

TE Material Declaration

English

Agency Approvals

UL Report

English

UL Report

English