

345807-1 ✓ ACTIVE

AMP | Econoseal

TE Internal #: 345807-1

Automotive Terminals, Tab, Mating Tab Width 1.8 mm [.071 in], Tab

Thickness .64 mm [.025 in], 18 – 14 AWG Wire Size, .75 – 2 mm²

Wire Size, Econoseal

[View on TE.com >](#)



Terminals & Splices > Automotive Terminals > Econoseal Receptacles and Tabs

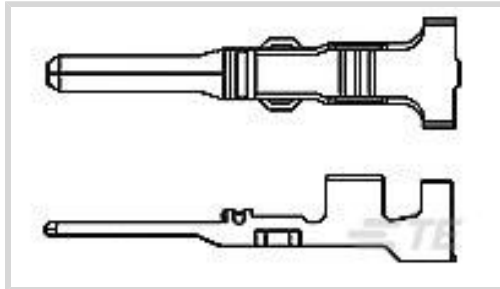

Terminal Type: **Tab**

Mating Tab Width: **1.8 mm [.071 in]**

Mating Tab Thickness: **.64 mm [.025 in]**

Terminal Transmits: **0 – 24 A (Low Power)**

Wire Size: **18 – 14 AWG**

[All Econoseal Receptacles and Tabs \(45\)](#)

Features

Product Type Features

Sealable	Yes
----------	-----

Body Features

Terminal Seal Type	Single Wire Seal (SWS)
--------------------	------------------------

Contact Features

Contact Size	1.8mm
Contact Fabrication	Stamped & Formed
Typical Current Rating	10 A
Crimp Type	F-Crimp
Terminal Type	Tab
Mating Tab Width	1.8 mm[.071 in]
Mating Tab Thickness	.64 mm[.025 in]
Interface Plating	Tin (Sn)

Termination Features

Termination Method to Wire & Cable	Crimp
Product Terminates To	Wire

Dimensions

--	--



Compatible Insulation Diameter Range	1.65 – 2.7 mm [.065 – .106 in]
Wire Size	.75 – 2 mm ²
Wire Size Search	14 AWG, 15 AWG, 16 AWG, 17 AWG, 18 AWG

Usage Conditions

Insulation Option	Uninsulated
-------------------	-------------

Operation/Application

Compatible With Wire Base Material	Copper
------------------------------------	--------

Packaging Features

Packaging Quantity	6000
Packaging Method	Reel

Other

Terminal Transmits	0 – 24 A (Low Power)
--------------------	----------------------

Product Compliance

[For compliance documentation, visit the product page on TE.com>](#)

EU RoHS Directive 2011/65/EU	Compliant
EU ELV Directive 2000/53/EC	Compliant
China RoHS 2 Directive MIIT Order No 32, 2016	No Restricted Materials Above Threshold
EU REACH Regulation (EC) No. 1907/2006	Current ECHA Candidate List: JUNE 2023 (235) Candidate List Declared Against: JUNE 2023 (235) Does not contain REACH SVHC
Halogen Content	Low Halogen - Br, Cl, F, I < 900 ppm per homogenous material. Also BFR/CFR/PVC Free
Solder Process Capability	Not applicable for solder process capability

Product Compliance Disclaimer

This information is provided based on reasonable inquiry of our suppliers and represents our current actual knowledge based on the information they provided. This information is subject to change. The part numbers that TE has identified as EU RoHS compliant have a maximum concentration of 0.1% by weight in homogenous materials for lead, hexavalent chromium, mercury, PBB, PBDE, DBP, BBP, DEHP, DIBP, and 0.01% for cadmium, or qualify for an exemption to these limits as defined in the Annexes of Directive 2011/65/EU (RoHS2). Finished electrical and electronic equipment products will be CE marked as required by Directive 2011/65/EU. Components may not be CE marked. Additionally, the part numbers that TE has identified as EU ELV compliant have a maximum concentration of 0.1% by weight in homogenous materials for lead, hexavalent chromium, and mercury, and 0.01% for cadmium, or qualify for an exemption to these limits as defined in the Annexes of Directive 2000/53/EC (ELV). Regarding the REACH Regulation, the information TE provides

on SVHC in articles for this part number is based on the latest European Chemicals Agency (ECHA) 'Guidance on requirements for substances in articles' posted at this URL: <https://echa.europa.eu/guidance-documents/guidance-on-reach>

Compatible Parts



TE Part # 2305570-1
Strip Terminal Cutter-Side Feed-No Crimp



TE Part # CAT-EC7491-CH8172
ECONOSEAL, CONNECTOR HOUSING



TE Part # 345806-1
ECONO CONTACT REC



TE Part # 1-1579007-5
EXTRACTION TOOL



TE Part # 2151938-1
OCEAN_2.0_Applicator-S-090F1450



TE Part # 2151938-2
OCEAN_2.0_Applicator-S-090F1450



TE Part # 7-2151938-7
OCEAN_2.0_SPARE_PART_KIT-090F1450



TE Part # 2-2151938-1
OCEAN_2.0_Applicator-S-090F1450



TE Part # 172888-2
E-J MK-2 070 RUBBER

Also in the Series | Econoseal

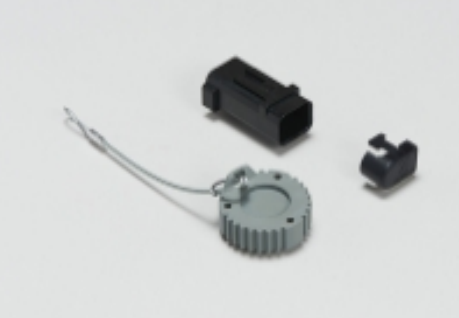

Automotive Connector Caps & Covers (1)



Automotive Connector Locks & Position Assurance(25)



Automotive Housings(105)



Automotive Terminals(48)

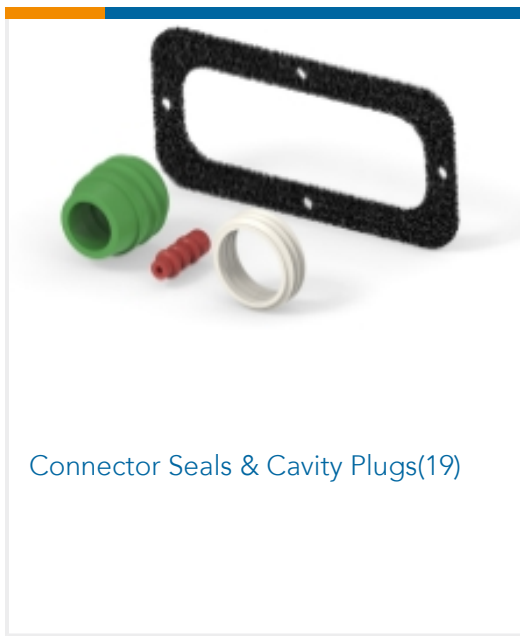

Connector Seals & Cavity Plugs(19)

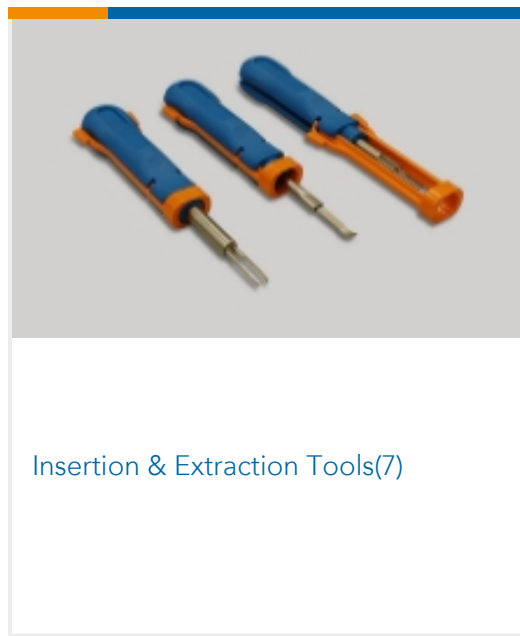

Insertion & Extraction Tools(7)

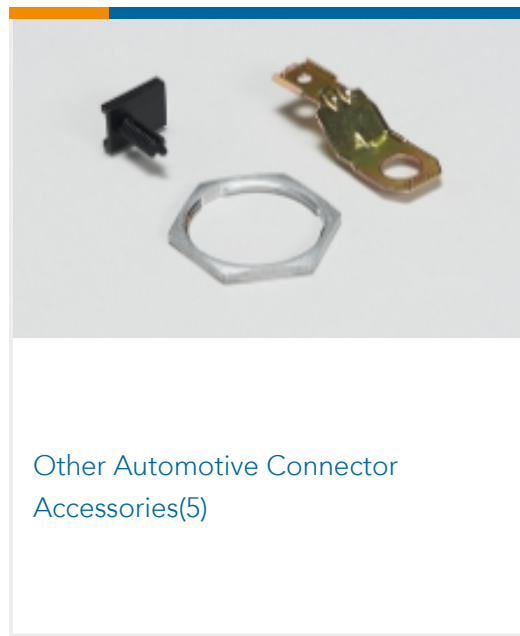

Other Automotive Connector Accessories(5)



PCB Headers & Receptacles(4)

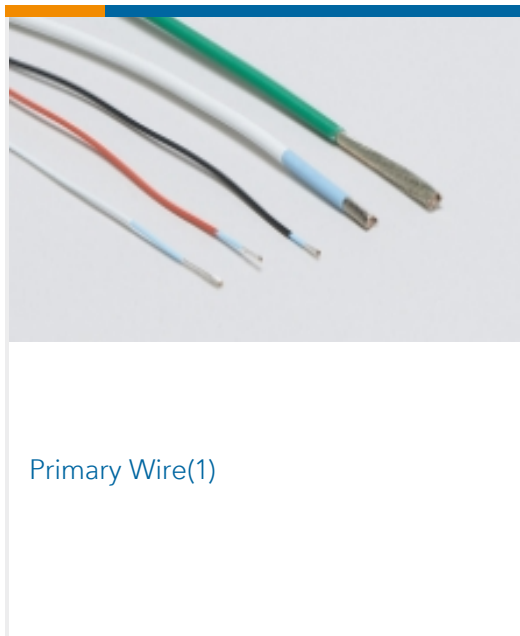

Primary Wire(1)

Customers Also Bought



TE Part #1534594-3
MCON 1.2 CB REC SRC AG



TE Part #1-345361-1
3 WAY HDR FOR ECONOSEAL 3STRAI



TE Part #344274-1
2 WAY TAB HOUSING BLACK ECONO

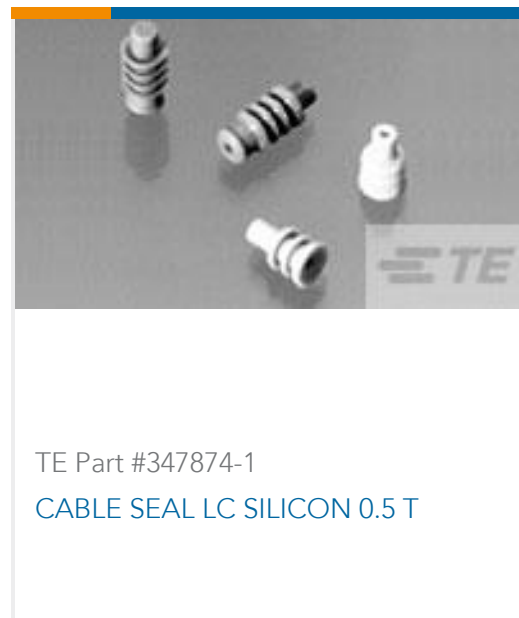

TE Part #347874-1
CABLE SEAL LC SILICON 0.5 T



TE Part #2292906-1
2POS,MCON 1.2,REC HSG ASSY,SLD,
COD A



TE Part #2292906-2
2POS,MCON 1.2,REC HSG ASSY,SLD,
COD B



TE Part #ASDD606-09SE-HE
PLUG ASSEMBLY ASL 9-WAY

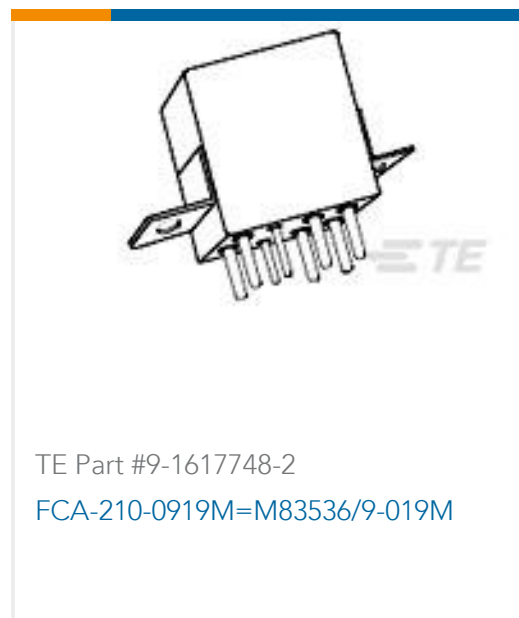

TE Part #9-1617748-2
FCA-210-0919M=M83536/9-019M



TE Part #345253-1
ANTI-BACKOUT 2WAY TAB
HSGECONO



TE Part #199135-000
382A012-15-0

Documents



Product Drawings

ECONO CONT. TAB

English

CAD Files

Customer View Model

[ENG_CVM_345807-1_A.3d_igs.zip](#)

English

Customer View Model

[ENG_CVM_345807-1_A.3d_stp.zip](#)

English

Customer View Model

[ENG_CVM_345807-1_A.2d_dxf.zip](#)

English

3D PDF

English

By downloading the CAD file I accept and agree to the [Terms and Conditions](#) of use.

Datasheets & Catalog Pages

Econoseal Connector Series

English

Product Specifications

Application Specification

English