

33173 ✓ ACTIVE

PIDG

TE Internal #: 33173

Rectangular Tongue Terminal, 16 AWG, M3.5 / #6 Stud Size, 3.51 mm [.138 in] Stud Diameter, Closed Barrel, Straight, Tin, Partially Insulated, PIDG

[View on TE.com >](#)



Terminals & Splices > Spade Terminals > PIDG Rectangular Tongue Terminals

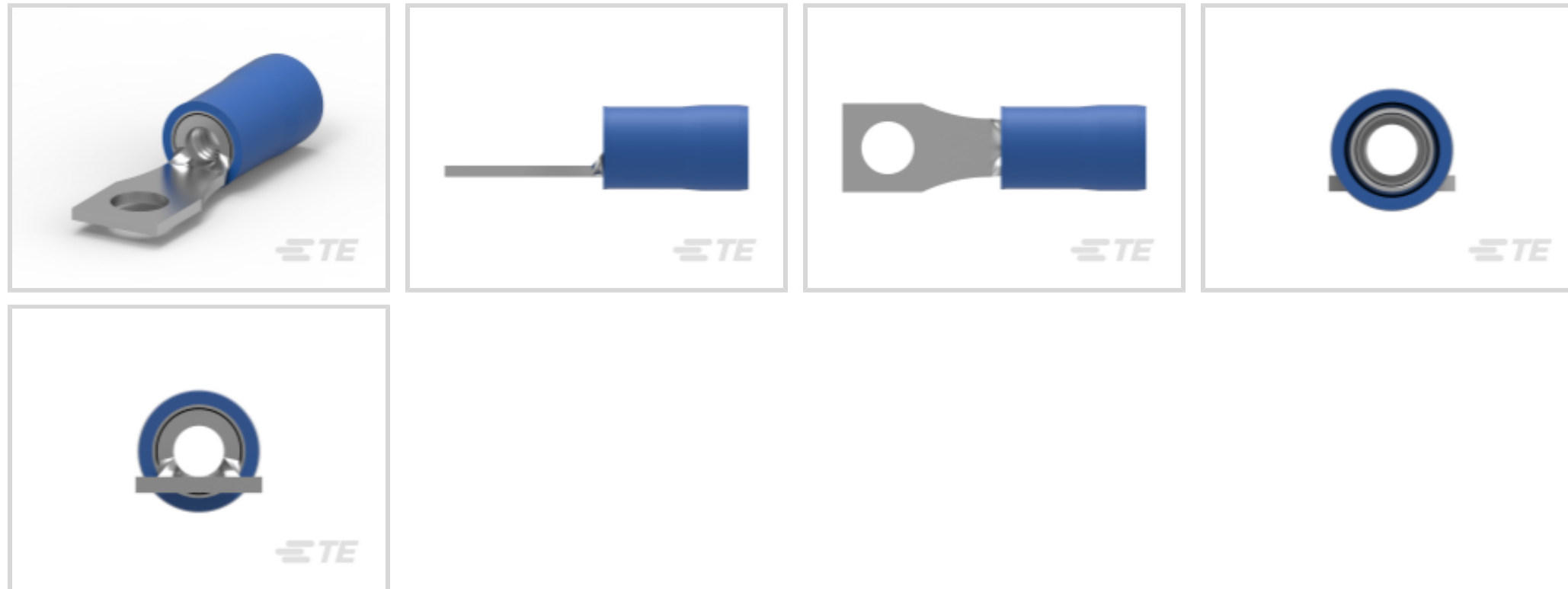

Spade Terminal Type: **Rectangular Tongue Terminal**

Wire Size: **2050 – 5180 CMA**

Stud Size: **#6, M3.5**

[All PIDG Rectangular Tongue Terminals \(31\)](#)

## Features

### Product Type Features

Stud Size	#6, M3.5
Sealable	No
Wire Insulation Support Retention Type	Non-Insulation Support

### Configuration Features

Number of Holes	1
-----------------	---

### Electrical Characteristics

Voltage Rating	300 V
----------------	-------

### Body Features

Insulation Sleeve Color	Blue
Stripe Color	Blue

### Contact Features

Spade Terminal Type	Rectangular Tongue Terminal
Barrel Type	Closed



Terminal Orientation	Straight
----------------------	----------

Terminal Plating Material	Tin
---------------------------	-----

### Mechanical Attachment

Wire Insulation Support	With
-------------------------	------

### Dimensions

Wire Size	2050 – 5180 CMA
-----------	-----------------

Stud Diameter	3.51 mm [.138 in]
---------------	-------------------

Tongue Thickness	.84 mm [.033 in]
------------------	------------------

Product Length	21.74 mm [.679 in]
----------------	--------------------

Compatible Insulation Diameter (Max)	4.32 mm [.17 in]
--------------------------------------	------------------

Compatible Insulation Diameter Range	2.92 – 4.31 mm [.115 – .17 in]
--------------------------------------	--------------------------------

### Usage Conditions

Insulation Option	Partially Insulated
-------------------	---------------------

Operating Temperature Range	105 °C [221 °F]
-----------------------------	-----------------

### Operation/Application

Compatible With Wire Base Material	Copper
------------------------------------	--------

Compatible With Wire Plating Material	Tin
---------------------------------------	-----

### Industry Standards

Government Qualified Terminal	No
-------------------------------	----

### Packaging Features

Packaging Quantity	1000
--------------------	------

Packaging Method	Box
------------------	-----

### Product Compliance

[For compliance documentation, visit the product page on TE.com>](#)

EU RoHS Directive 2011/65/EU	Compliant
------------------------------	-----------

EU ELV Directive 2000/53/EC	Compliant
-----------------------------	-----------

China RoHS 2 Directive MIIT Order No 32, 2016	No Restricted Materials Above Threshold
---	---

EU REACH Regulation (EC) No. 1907/2006	Current ECHA Candidate List: JUNE 2023 (235) Candidate List Declared Against: JUNE 2023 (235) Does not contain REACH SVHC
--	---













Halogen Content	Low Halogen - Br, Cl, F, I < 900 ppm per homogenous material. Also BFR/CFR/PVC Free
Solder Process Capability	Not applicable for solder process capability

Product Compliance Disclaimer

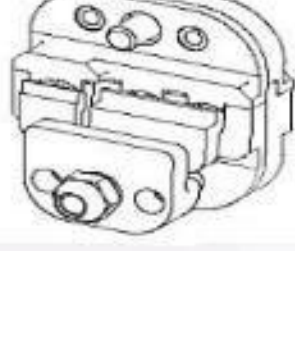
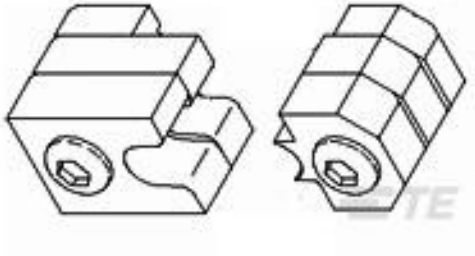
This information is provided based on reasonable inquiry of our suppliers and represents our current actual knowledge based on the information they provided. This information is subject to change. The part numbers that TE has identified as EU RoHS compliant have a maximum concentration of 0.1% by weight in homogenous materials for lead, hexavalent chromium, mercury, PBB, PBDE, DBP, BBP, DEHP, DIBP, and 0.01% for cadmium, or qualify for an exemption to these limits as defined in the Annexes of Directive 2011/65/EU (RoHS2). Finished electrical and electronic equipment products will be CE marked as required by Directive 2011/65/EU. Components may not be CE marked. Additionally, the part numbers that TE has identified as EU ELV compliant have a maximum concentration of 0.1% by weight in homogenous materials for lead, hexavalent chromium, and mercury, and 0.01% for cadmium, or qualify for an exemption to these limits as defined in the Annexes of Directive 2000/53/EC (ELV). Regarding the REACH Regulation, the information TE provides on SVHC in articles for this part number is based on the latest European Chemicals Agency (ECHA) 'Guidance on requirements for substances in articles' posted at this URL: <https://echa.europa.eu/guidance-documents/guidance-on-reach>

### Compatible Parts

 <p>TE Part # 59824-1 TETRA-CRIMP PIDG PG FASTON 22-10 ASSY</p>	 <p>TE Part # 59250 T-HEAD PIDG 26-14 ASSY</p>	 <p>TE Part # 47387 DAHT PG PIDG 20-14 ASSY</p>	 <p>TE Part # 58423-1 DIE, RBY IS9252</p>
 <p>TE Part # 58433-3 PRO CR ASSY, RBY IS9252</p>	 <p>TE Part # 525691 DAHT PG PIDG 16-14 ASSY</p>	 <p>TE Part # 539691-2 ERGO DIE R.B.Y</p>	 <p>TE Part # 2063030-1 SDE DIESET, RBY, UL</p>
 <p>TE Part # 47807-1 DIES PIDG 16-14 DIE SET</p>	 <p>TE Part # 169400 CERTI-LOK FRAME W/O DIES</p>	 <p>TE Part # 1SET191002R0000 TET CRIMP-HT</p>	 <p>TE Part # 169404 CERTI-LOK DIE</p>

### Also in the Series | PIDG



Compression Connectors(17)



Crimp Terminal Housings(1)



Crimp Wire Pins, Tabs & Ferrules(41)



Hand Crimping Tools(2)



Knife Disconnects(11)



PCB Terminals(7)



Quick Disconnects(49)



Ring Terminals(611)



Spade Terminals(233)



Special Purpose Terminals(1)



Splices(46)

## Customers Also Bought



TE Part #DT04-08PA-CL03  
REC, 8P, GRY, E, FLANGE, A

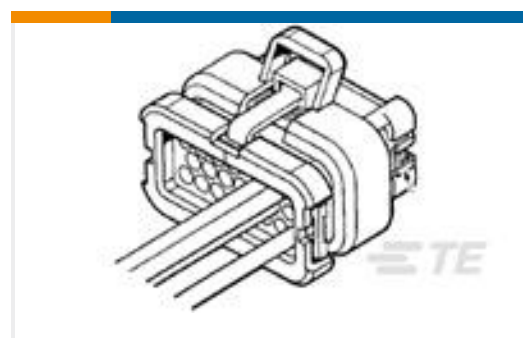

TE Part #776286-2  
8POS,AMPSEAL,SOC HSG ASSY,SLD,  
COD 2



TE Part #1735447-4  
HPI 2.0 RECEPTACLE HOUSING, 4P



TE Part #3-643817-6  
06P MTA156 CONN ASSY 18AWG  
ORA



TE Part #3-640599-3  
03P MTA156 CONN ASSY 18AWG  
ORA

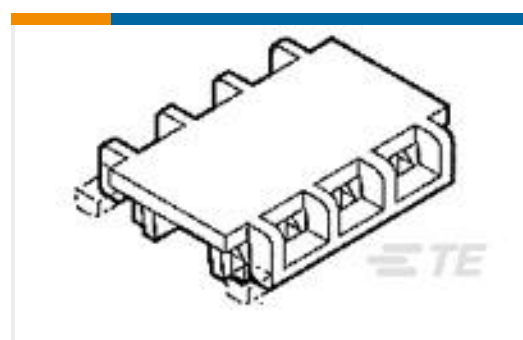

TE Part #643071-3  
03P MTA156 FD-THRU COVER



TE Part #3-641437-2  
02P MTA156 PSTD CONN ASSY RED



TE Part #474835-E  
SRCP 1,27 12 F 1-KS IDC22 137 E1 162  
1,2



## Documents

### Product Drawings

[TERMINAL,PIDG RECT 16-14 6](#)

English

### CAD Files

Customer View Model

[ENG\\_CVM\\_CVM\\_33173\\_H.2d\\_dxf.zip](#)

English

[3D PDF](#)

3D

Customer View Model

[ENG\\_CVM\\_CVM\\_33173\\_H.3d\\_igs.zip](#)

English

Customer View Model

[ENG\\_CVM\\_CVM\\_33173\\_H.3d\\_stp.zip](#)

English

By downloading the CAD file I accept and agree to the [Terms and Conditions](#) of use.

### Product Specifications

[Application Specification](#)

English

### Product Environmental Compliance

[TE Material Declaration](#)

English

### Agency Approvals

[UL Report](#)

English