

32960 ✓ ACTIVE

PLASTI-GRIP

TE Internal #: 32960

Closed Ring Tongue Terminal, 16 AWG, #10 Stud Size, 4.82 mm [.19 in] Stud Diameter, Closed Barrel, Straight, Tin, Partially Insulated, PLASTI-GRIP

[View on TE.com >](#)



Terminals & Splices > Ring Terminals

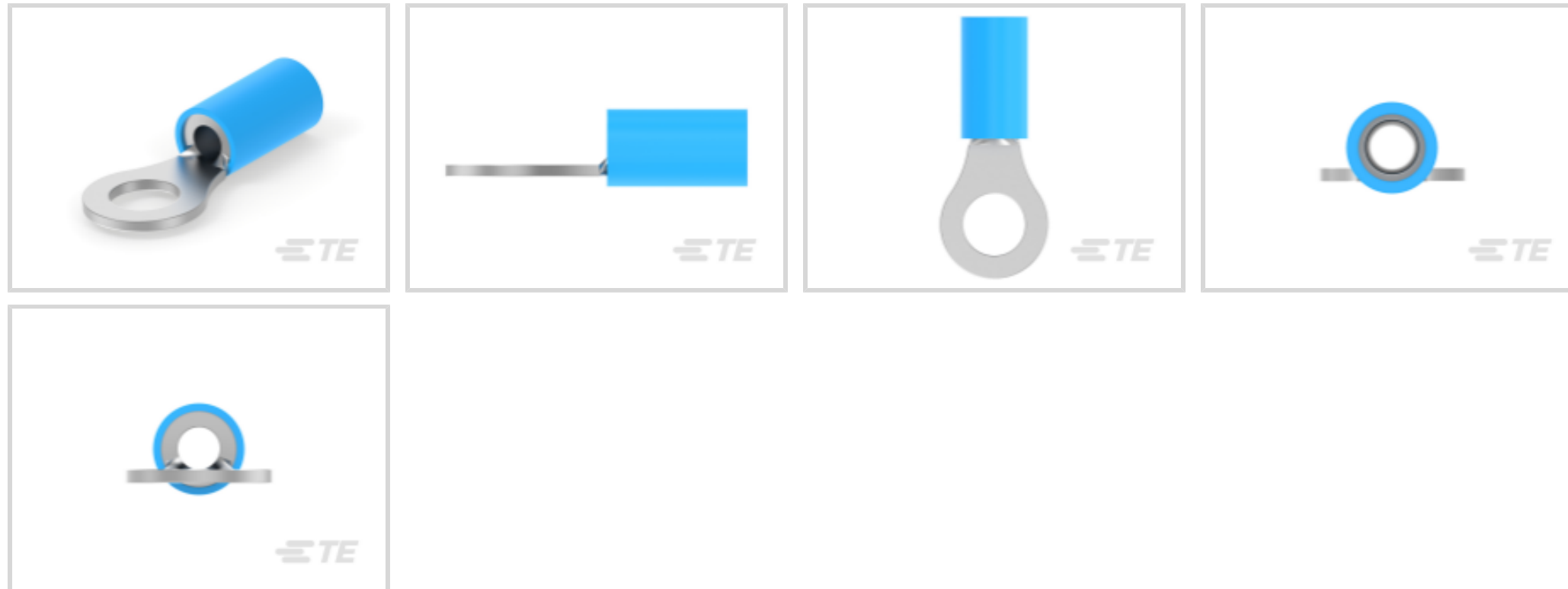

Ring Terminal Product Type: Closed Ring Tongue Terminal

Wire Size: 2050 – 5180 CMA

Stud Size: #10

### Features

#### Product Type Features

Ring Terminal Product Type	Closed Ring Tongue Terminal
Stud Size	#10
Sealable	No
Wire Insulation Support Retention Type	Insulation Support

#### Configuration Features

Number of Holes	1
-----------------	---

#### Electrical Characteristics

Voltage Rating	600 V
----------------	-------

#### Body Features

Insulation Sleeve Color	Blue
Stripe Color	Blue

#### Contact Features

Barrel Type	Closed
Terminal Orientation	Straight
Terminal Plating Material	Tin



### Mechanical Attachment

Wire Insulation Support	With
-------------------------	------

### Dimensions

Wire Size	2050 – 5180 CMA
Stud Diameter	4.82 mm [.19 in]
Tongue Thickness	.84 mm [.033 in]
Product Length	22.12 mm [.871 in]
Compatible Insulation Diameter (Max)	3.81 mm [.15 in]
Compatible Insulation Diameter Range	2.67 – 3.81 mm [.105 – .15 in]

### Usage Conditions

Insulation Option	Partially Insulated
Operating Temperature Range	105 °C [221 °F]

### Operation/Application

Compatible With Wire Base Material	Copper
Compatible With Wire Plating Material	Tin

### Industry Standards

Government Qualified Terminal	No
-------------------------------	----

### Packaging Features

Packaging Quantity	1000
Packaging Method	Loose Piece

### Product Compliance











[For compliance documentation, visit the product page on TE.com>](#)

EU RoHS Directive 2011/65/EU	Compliant
EU ELV Directive 2000/53/EC	Compliant
China RoHS 2 Directive MIIT Order No 32, 2016	No Restricted Materials Above Threshold
EU REACH Regulation (EC) No. 1907/2006	Current ECHA Candidate List: JUNE 2023 (235) Candidate List Declared Against: JUNE 2023 (235) Does not contain REACH SVHC
Halogen Content	Not Low Halogen - contains Br or Cl > 900 ppm.
Solder Process Capability	Not applicable for solder process capability

## Product Compliance Disclaimer

This information is provided based on reasonable inquiry of our suppliers and represents our current actual knowledge based on the information they provided. This information is subject to change. The part numbers that TE has identified as EU RoHS compliant have a maximum concentration of 0.1% by weight in homogenous materials for lead, hexavalent chromium, mercury, PBB, PBDE, DBP, BBP, DEHP, DIBP, and 0.01% for cadmium, or qualify for an exemption to these limits as defined in the Annexes of Directive 2011/65/EU (RoHS2). Finished electrical and electronic equipment products will be CE marked as required by Directive 2011/65/EU. Components may not be CE marked. Additionally, the part numbers that TE has identified as EU ELV compliant have a maximum concentration of 0.1% by weight in homogenous materials for lead, hexavalent chromium, and mercury, and 0.01% for cadmium, or qualify for an exemption to these limits as defined in the Annexes of Directive 2000/53/EC (ELV). Regarding the REACH Regulation, the information TE provides on SVHC in articles for this part number is based on the latest European Chemicals Agency (ECHA) 'Guidance on requirements for substances in articles' posted at this URL: <https://echa.europa.eu/guidance-documents/guidance-on-reach>

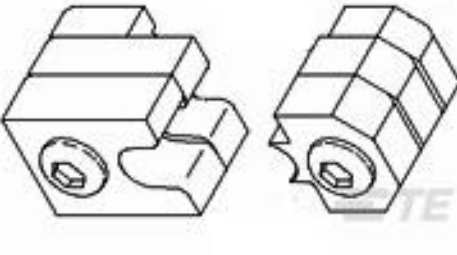
## Compatible Parts

 <p>TE Part # 59170 T-HEAD PIDG SH 26-14 ASSY</p>	 <p>TE Part # 59824-1 TETRA-CRIMP PIDG PG FASTON 22-10 ASSY</p>	 <p>TE Part # 59250 T-HEAD PIDG 26-14 ASSY</p>	 <p>REPRESENTATION ONLY</p> <p>TE Part # 47387 DAHT PG PIDG 20-14 ASSY</p>
 <p>TE Part # 58423-1 DIE, RBY IS9252</p>	 <p>TE Part # 58433-3 PRO CR ASSY, RBY IS9252</p>	 <p>REPRESENTATION ONLY</p> <p>TE Part # 525691 DAHT PG PIDG 16-14 ASSY</p>	 <p>TE Part # 539691-2 ERGO DIE R.B.Y</p>
 <p>TE Part # 2063030-1 SDE DIESET, RBY, UL</p>	 <p>TE Part # 47807-1 DIES PIDG 16-14 DIE SET</p>	 <p>TE Part # 169400 CERTI-LOK FRAME W/O DIES</p>	 <p>TE Part # 1SET191002R0000 TET CRIMP-HT</p>



## Also in the Series | PLASTI-GRIP

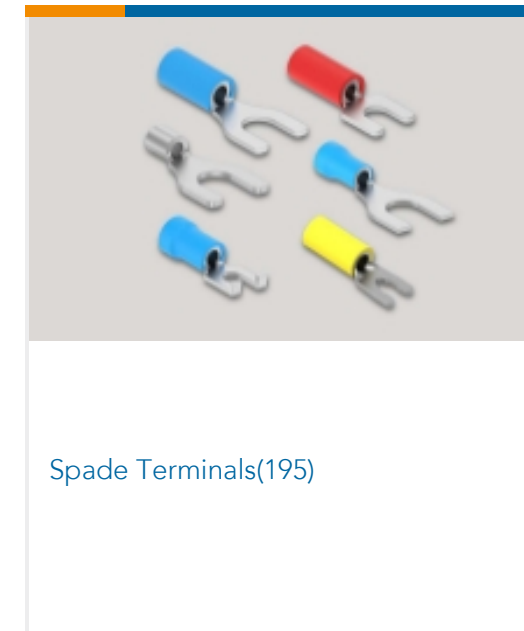
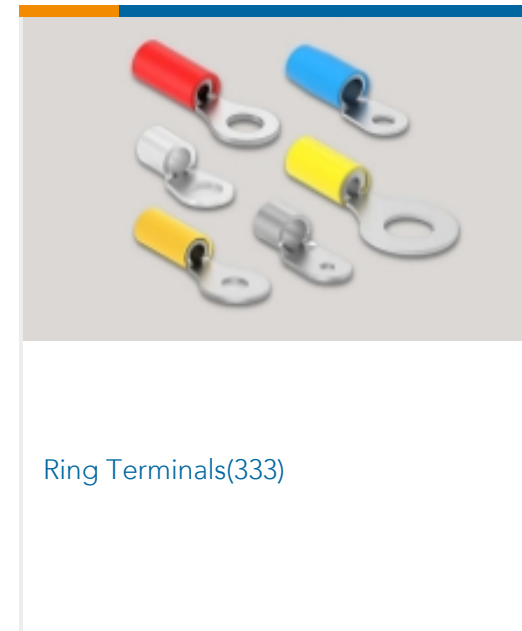
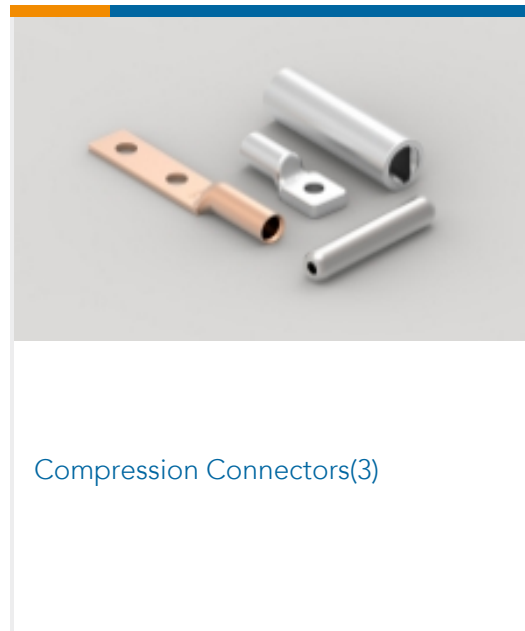

## Customers Also Bought

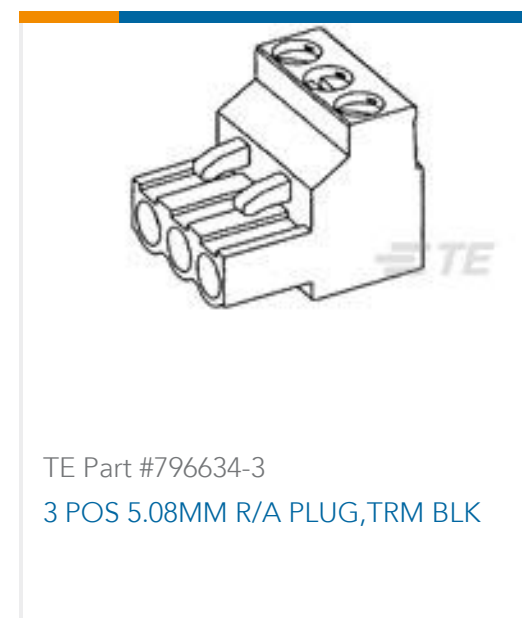





## Documents

### Product Drawings

[TERMINAL,PG R 16-14 10](#)

English

### CAD Files

Customer View Model

[ENG\\_CVM\\_CVM\\_32960\\_S.2d\\_dxf.zip](#)

English

[3D PDF](#)

3D

Customer View Model

[ENG\\_CVM\\_CVM\\_32960\\_S.3d\\_igs.zip](#)

English

Customer View Model

[ENG\\_CVM\\_CVM\\_32960\\_S.3d\\_stp.zip](#)

English

By downloading the CAD file I accept and agree to the [Terms and Conditions](#) of use.

### Product Specifications

[Application Specification](#)

English

### Product Environmental Compliance

[MD\\_32960\\_10312017948\\_dmtec](#)

English

[MD\\_32960\\_10312017948\\_dmtec](#)

English

### Agency Approvals

[UL Report](#)

English

[UL Report](#)

English

[UL Report](#)

English

[UL Report](#)

32960

Closed Ring Tongue Terminal, 16 AWG, #10 Stud Size, 4.82 mm [.19 in] Stud Diameter, Closed Barrel, Straight, Tin, Partially Insulated, PLASTI-GRIP



English