

328999 ✓ ACTIVE



## PIDG

TE Internal #: 328999

Closed Ring Tongue Terminal, 16 – 14 AWG, 3/8 Stud Size, 9.91 mm [.39 in] Stud Diameter, Closed Barrel, Straight, Tin, Partially Insulated, PIDG

[View on TE.com >](#)

Terminals & Splices > Ring Terminals > PIDG Ring Tongue Terminals

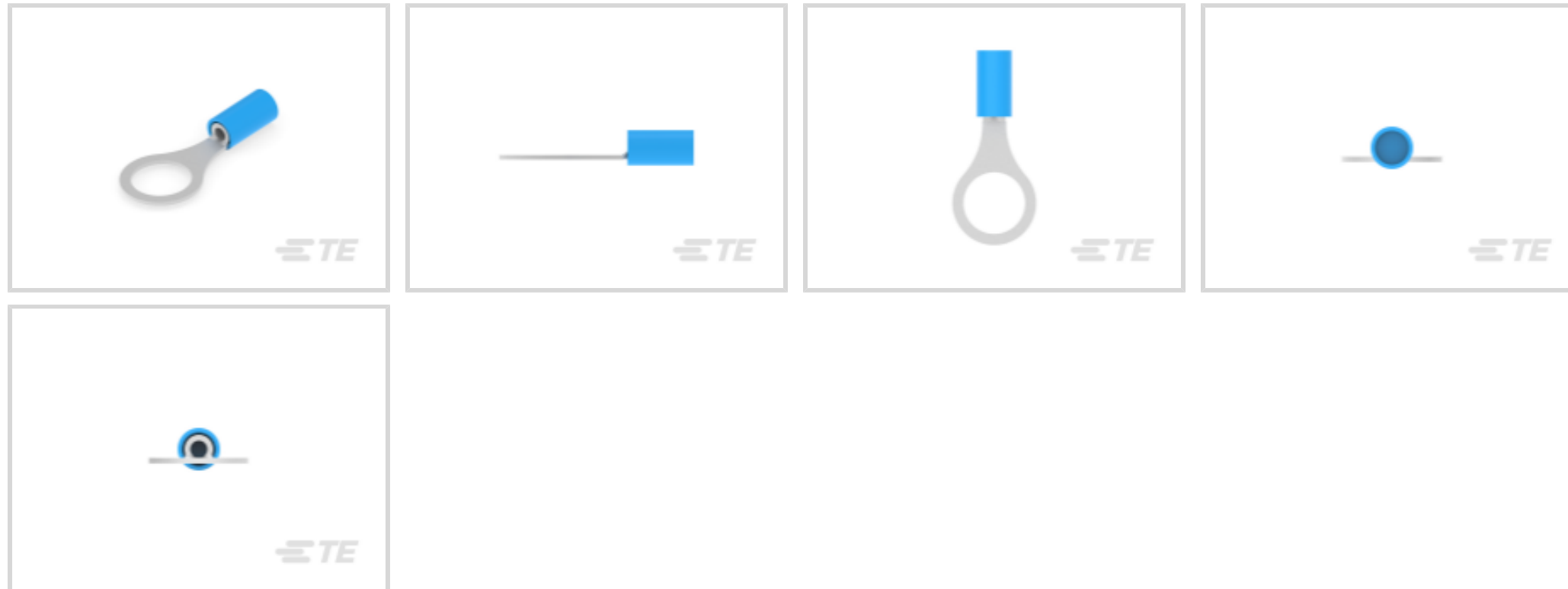

Ring Terminal Product Type: Closed Ring Tongue Terminal

Wire Size: 2050 – 5180 CMA

Stud Size: 3/8

[All PIDG Ring Tongue Terminals \(414\)](#)

## Features

### Product Type Features

Terminal Features	Sheared
Ring Terminal Product Type	Closed Ring Tongue Terminal
Stud Size	3/8
Sealable	No
Wire Insulation Support Retention Type	Insulation Support

### Configuration Features

Number of Holes	1
-----------------	---

### Electrical Characteristics

Voltage Rating	300 V
----------------	-------

### Body Features

Product Weight	1.363 g
Insulation Sleeve Color	Blue
Stripe Color	Blue

### Contact Features



Barrel Type	Closed
Terminal Orientation	Straight
Terminal Plating Material	Tin

### Mechanical Attachment

Wire Insulation Support	With
-------------------------	------

### Dimensions

Wire Size	2050 – 5180 CMA
Stud Diameter	9.91 mm [.39 in]
Tongue Thickness	.79 mm [.031 in]
Product Length	30.94 mm [1.218 in]
Compatible Insulation Diameter (Max)	4.32 mm [.17 in]
Compatible Insulation Diameter Range	2.92 – 4.31 mm [.115 – .17 in]

### Usage Conditions

Insulation Option	Partially Insulated
Operating Temperature Range	105 °C [221 °F]

### Operation/Application

Compatible With Wire Base Material	Copper
Compatible With Wire Plating Material	Tin

### Industry Standards

Government Qualified Terminal	No
-------------------------------	----

### Packaging Features

Packaging Quantity	1000
Packaging Method	Loose Piece

### Product Compliance

[For compliance documentation, visit the product page on TE.com>](#)

EU RoHS Directive 2011/65/EU	Compliant
EU ELV Directive 2000/53/EC	Compliant
China RoHS 2 Directive MIIT Order No 32, 2016	No Restricted Materials Above Threshold
EU REACH Regulation (EC) No. 1907/2006	Current ECHA Candidate List: JUNE 2023 (235) Candidate List Declared Against: JUNE 2023 (235)

Does not contain REACH SVHC

Halogen Content

Low Halogen - Br, Cl, F, I < 900 ppm per homogenous material. Also BFR/CFR/PVC Free

Solder Process Capability

Not applicable for solder process capability

Product Compliance Disclaimer

This information is provided based on reasonable inquiry of our suppliers and represents our current actual knowledge based on the information they provided. This information is subject to change. The part numbers that TE has identified as EU RoHS compliant have a maximum concentration of 0.1% by weight in homogenous materials for lead, hexavalent chromium, mercury, PBB, PBDE, DBP, BBP, DEHP, DIBP, and 0.01% for cadmium, or qualify for an exemption to these limits as defined in the Annexes of Directive 2011/65/EU (RoHS2). Finished electrical and electronic equipment products will be CE marked as required by Directive 2011/65/EU. Components may not be CE marked. Additionally, the part numbers that TE has identified as EU ELV compliant have a maximum concentration of 0.1% by weight in homogenous materials for lead, hexavalent chromium, and mercury, and 0.01% for cadmium, or qualify for an exemption to these limits as defined in the Annexes of Directive 2000/53/EC (ELV). Regarding the REACH Regulation, the information TE provides on SVHC in articles for this part number is based on the latest European Chemicals Agency (ECHA) 'Guidance on requirements for substances in articles' posted at this URL: <https://echa.europa.eu/guidance-documents/guidance-on-reach>

## Compatible Parts

TE Part # 59824-1  
TETRA-CRIMP PIDG PG FASTON 22-10 ASSY

TE Part # 59250  
T-HEAD PIDG 26-14 ASSY

TE Part # 47387  
DAHT PG PIDG 20-14 ASSY

TE Part # 58423-1  
DIE, RBY IS9252

TE Part # 47387-7  
DAHT PG PIDG 16-12 ASSY

TE Part # 58433-3  
PRO CR ASSY, RBY IS9252

TE Part # 525691  
DAHT PG PIDG 16-14 ASSY

TE Part # 539691-2  
ERGO DIE R.B.Y

TE Part # 1-47387-0  
DAHT PIDG PG 16-14 HEAD

TE Part # 2063030-1  
SDE DIESET, RBY, UL

TE Part # 47807-1  
DIES PIDG 16-14 DIE SET

TE Part # 169400  
CERTI-LOK FRAME W/O DIES

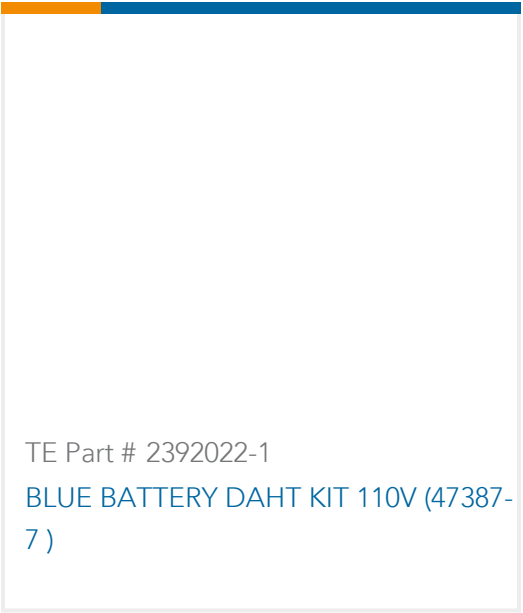
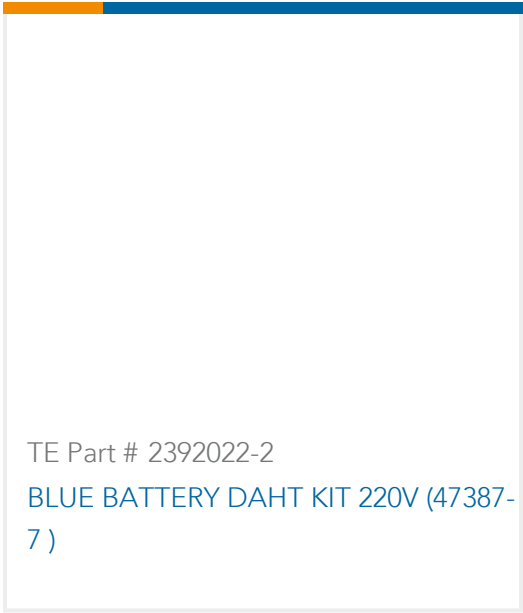

Also in the Series | PIDG

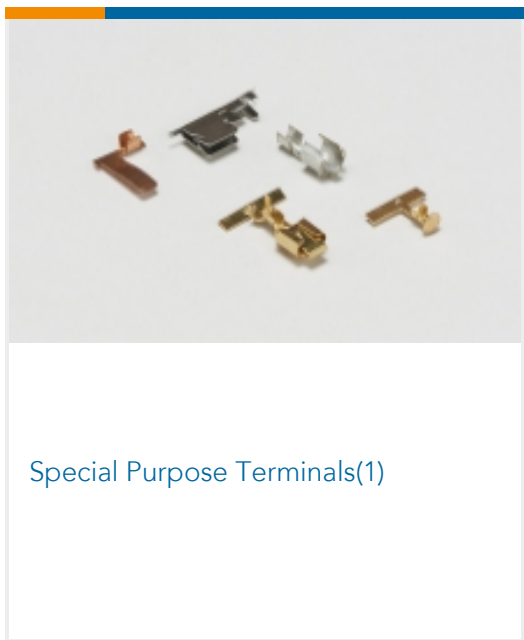
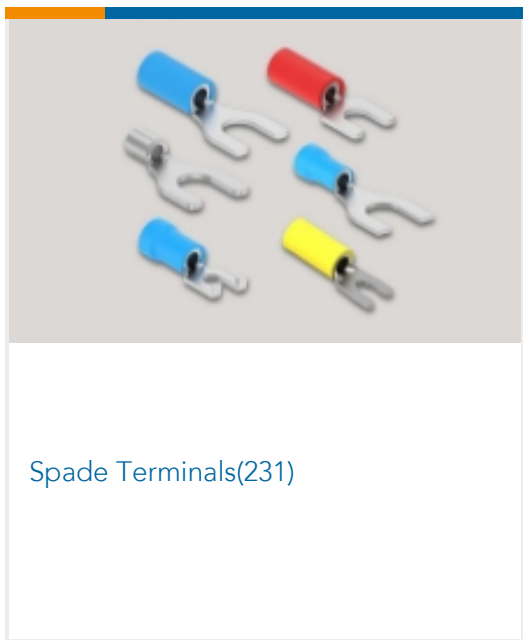
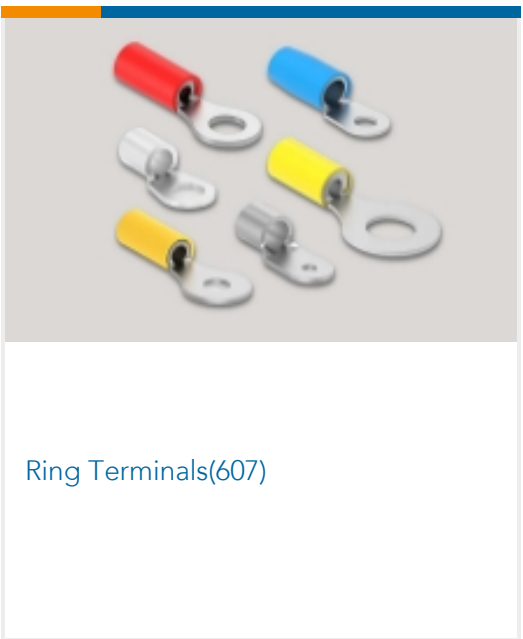
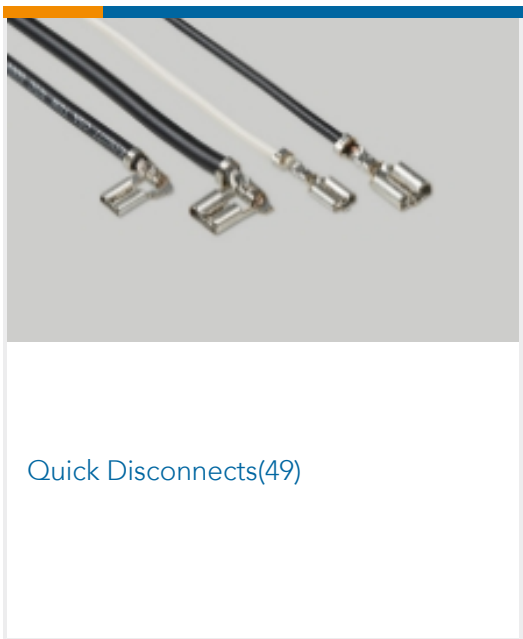
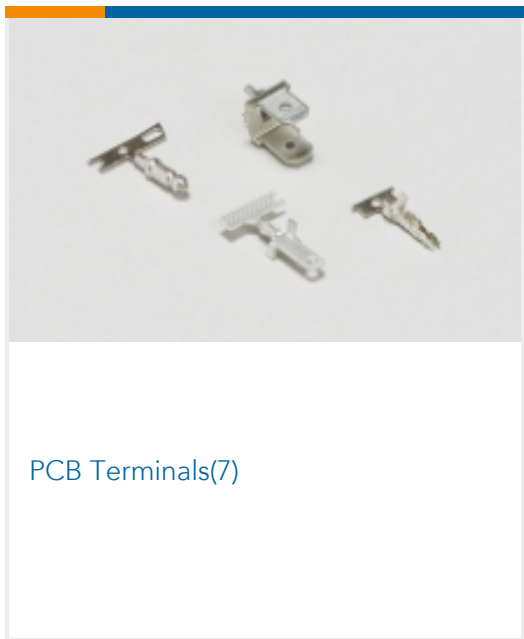
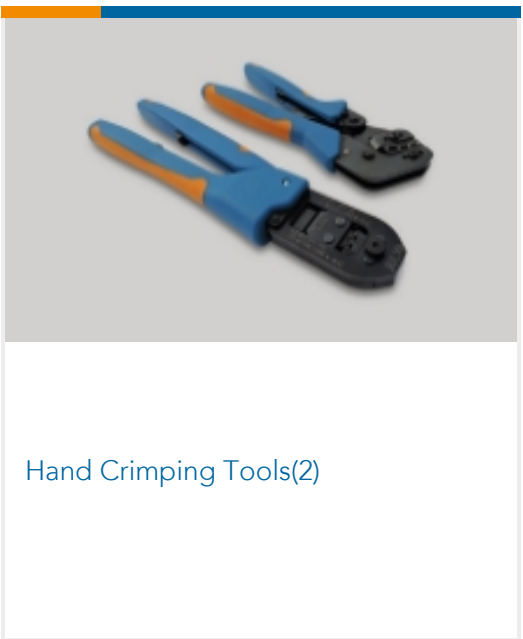
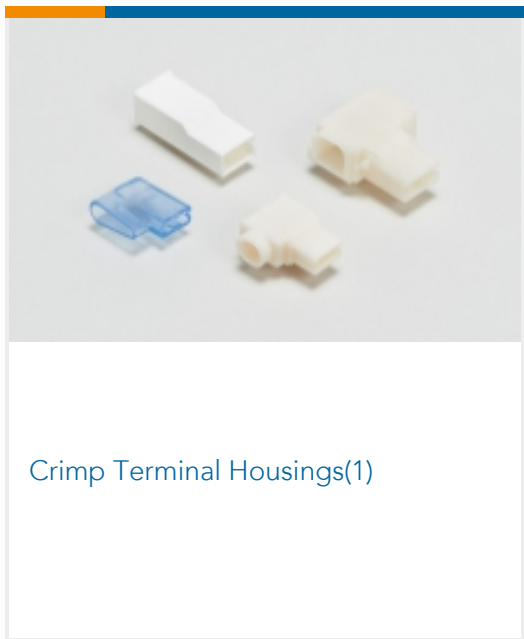
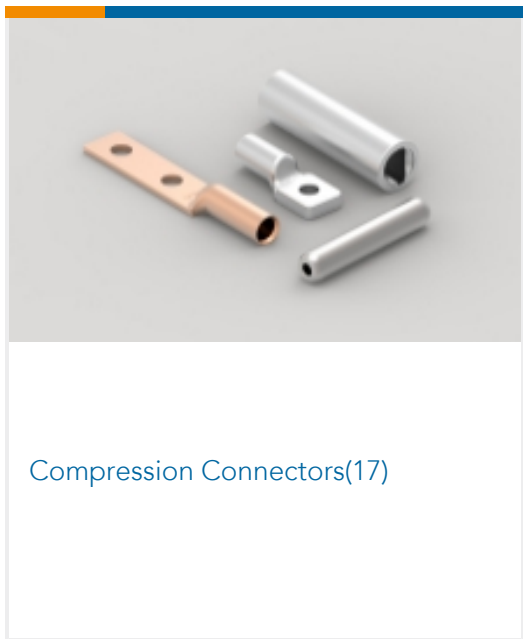

Customers Also Bought





TE Part #324225  
PLUG,SHUR PIDG 16-14



TE Part #8-328281-1  
TERMINAL,PIDG SPD 16-14 6



TE Part #322375  
DIAMOND GRIP 16-14 HR R 10



TE Part #1-1825006-3  
GDS0804=DIP SW,SLIDE,THRU/HL



TE Part #9-1879354-5  
RR03 5% 2K7 AMMO



TE Part #936251-2  
090 SLD 3P PLUG ASSY BLACK

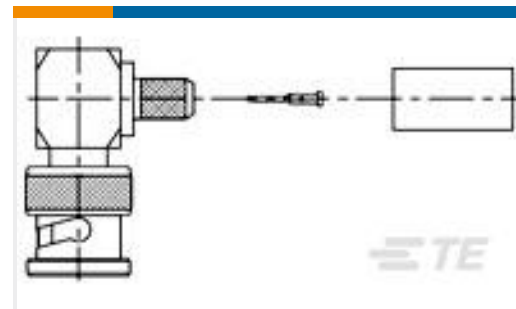

TE Part #1-1337544-0  
BNC R/A Plg Hex 50Ohm Nickel Pltd  
RG58C/



TE Part #2-1102647-5  
HIP-K.10/24.AG



TE Part #4-1106201-5  
HIPK/EMVK.6/16.SKB



TE Part #2-1102606-5  
HIP-K.6/16.AG.M6

## Documents

### Product Drawings

[TERMINAL,PIDG R 16-14 3/8](#)

English

### CAD Files

[3D PDF](#)

3D

Customer View Model

[ENG\\_CVM\\_CVM\\_328999\\_F.2d\\_dxf.zip](#)

English

Customer View Model

[ENG\\_CVM\\_CVM\\_328999\\_F.3d\\_igs.zip](#)

English

Customer View Model

[ENG\\_CVM\\_CVM\\_328999\\_F.3d\\_stp.zip](#)

English

Customer View Model

[ENG\\_CVM\\_328999\\_E.3d\\_igs.zip](#)

English



**Customer View Model**

[ENG\\_CVM\\_328999\\_E.3d\\_stp.zip](#)

English

**Customer View Model**

[ENG\\_CVM\\_328999\\_E.2d\\_dxf.zip](#)

English

**3D PDF**

English

By downloading the CAD file I accept and agree to the [Terms and Conditions](#) of use.

---

**Datasheets & Catalog Pages**

[PIDG TERMINALS & SPLICES Quick Reference Guide](#)

English

---

**Product Specifications**

[Application Specification](#)

English

---

**Product Environmental Compliance**

[MD\\_328999\\_05022013720\\_dmtec](#)

English

[MD\\_328999\\_05022013720\\_dmtec](#)

English

---

**Agency Approvals**

[UL Report](#)

English

[UL Report](#)

English