

328657

✓ ACTIVE



PIDG

TE Internal #: 328657

Closed Ring Tongue Terminal, 22 – 16 AWG, M2 / #2 Stud Size, 2.36 mm [.093 in] Stud Diameter, Closed Barrel, Straight, Tin, Partially Insulated, PIDG

[View on TE.com >](#)

Terminals & Splices > Ring Terminals > PIDG Ring Tongue Terminals

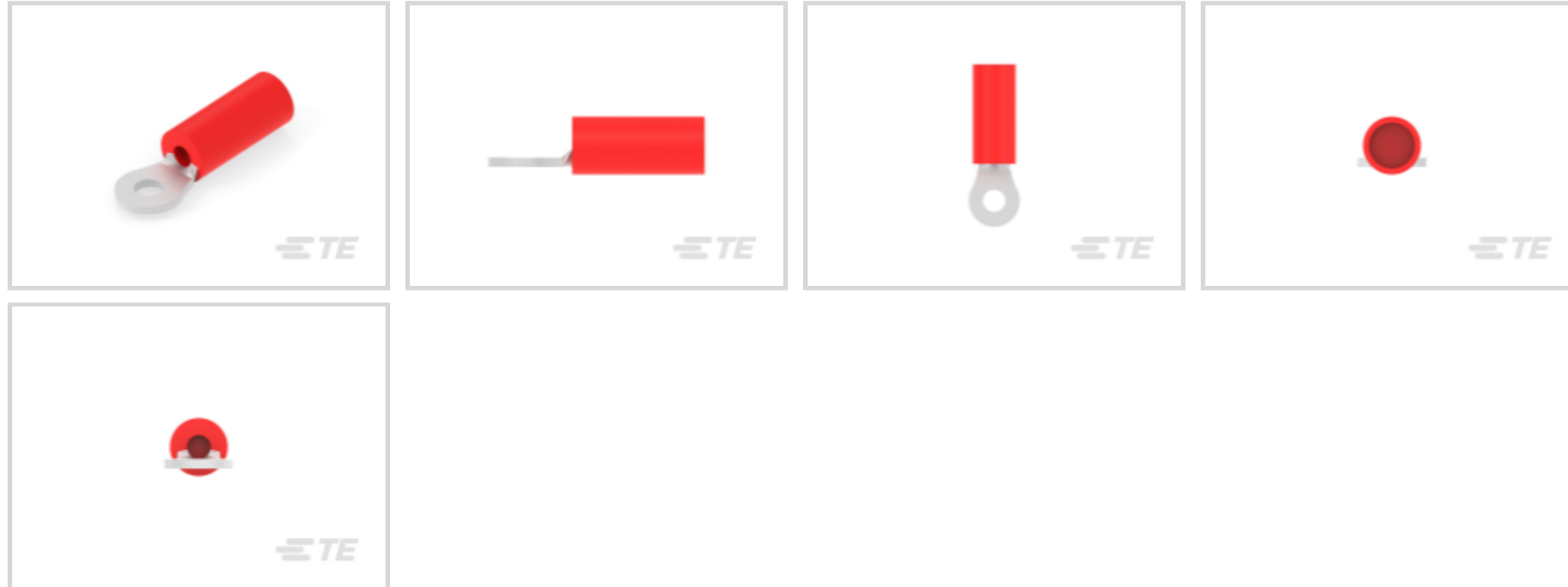

Ring Terminal Product Type: Closed Ring Tongue Terminal

Wire Size: 509 – 3260 CMA

Stud Size: #2, M2

[All PIDG Ring Tongue Terminals \(418\)](#)

Features

Product Type Features

Ring Terminal Product Type	Closed Ring Tongue Terminal
Stud Size	#2, M2
Sealable	No
Wire Insulation Support Retention Type	Insulation Support

Configuration Features

Number of Holes	1
-----------------	---

Electrical Characteristics

Voltage Rating	300 V
----------------	-------

Body Features

Product Weight	.6 g
----------------	------

Contact Features

Barrel Type	Closed
Terminal Orientation	Straight



Terminal Plating Material	Tin
---------------------------	-----

### Mechanical Attachment

Wire Insulation Support	With
-------------------------	------

### Dimensions

Wire Size	509 – 3260 CMA
-----------	----------------

Stud Diameter	2.36 mm [.093 in]
---------------	-------------------

Tongue Thickness	.79 mm [.031 in]
------------------	------------------

Product Length	17.07 mm [.672 in]
----------------	--------------------

Compatible Insulation Diameter (Max)	3.18 mm [.125 in]
--------------------------------------	-------------------

Compatible Insulation Diameter Range	2.03 – 3.18 mm [.08 – .125 in]
--------------------------------------	--------------------------------

### Usage Conditions

Insulation Option	Partially Insulated
-------------------	---------------------

Operating Temperature Range	105 °C [221 °F]
-----------------------------	-----------------

### Operation/Application

Compatible With Wire Base Material	Copper
------------------------------------	--------

Compatible With Wire Plating Material	Tin
---------------------------------------	-----

### Industry Standards

Government Qualified Terminal	No
-------------------------------	----

### Packaging Features

Packaging Quantity	1000
--------------------	------

Packaging Method	Loose Piece
------------------	-------------

### Product Compliance

For compliance documentation, visit the product page on [TE.com](https://www.te.com)>

EU RoHS Directive 2011/65/EU	Compliant
------------------------------	-----------

EU ELV Directive 2000/53/EC	Compliant
-----------------------------	-----------

China RoHS 2 Directive MIIT Order No 32, 2016	No Restricted Materials Above Threshold
---	---

EU REACH Regulation (EC) No. 1907/2006	Current ECHA Candidate List: JUNE 2023 (235) Candidate List Declared Against: JUNE 2023 (235) Does not contain REACH SVHC
--	---

Halogen Content	Low Halogen - Br, Cl, F, I < 900 ppm per homogenous material. Also BFR/CFR/PVC
-----------------	--

Free

Solder Process Capability

Not applicable for solder process capability

Product Compliance Disclaimer

This information is provided based on reasonable inquiry of our suppliers and represents our current actual knowledge based on the information they provided. This information is subject to change. The part numbers that TE has identified as EU RoHS compliant have a maximum concentration of 0.1% by weight in homogenous materials for lead, hexavalent chromium, mercury, PBB, PBDE, DBP, BBP, DEHP, DIBP, and 0.01% for cadmium, or qualify for an exemption to these limits as defined in the Annexes of Directive 2011/65/EU (RoHS2). Finished electrical and electronic equipment products will be CE marked as required by Directive 2011/65/EU. Components may not be CE marked. Additionally, the part numbers that TE has identified as EU ELV compliant have a maximum concentration of 0.1% by weight in homogenous materials for lead, hexavalent chromium, and mercury, and 0.01% for cadmium, or qualify for an exemption to these limits as defined in the Annexes of Directive 2000/53/EC (ELV). Regarding the REACH Regulation, the information TE provides on SVHC in articles for this part number is based on the latest European Chemicals Agency (ECHA) 'Guidance on requirements for substances in articles' posted at this URL: <https://echa.europa.eu/guidance-documents/guidance-on-reach>

### Compatible Parts



TE Part # 59824-1  
 TETRA-CRIMP PIDG PG FASTON 22-10 ASSY



REPRESENTATION ONLY

TE Part # 47386  
 DAHT PG PIDG 26-16 ASSY



REPRESENTATION ONLY

TE Part # 47386-4  
 DAHT PG PIDG 26-16 ASSY



TE Part # 59250  
 T-HEAD PIDG 26-14 ASSY



TE Part # 58423-1  
 DIE, RBY IS9252



TE Part # 58433-3  
 PRO CR ASSY, RBY IS9252



REPRESENTATION ONLY

TE Part # 525690  
 DAHT PG PIDG 20-18 ASSY



TE Part # 539691-2  
 ERGO DIE R.B.Y



TE Part # 2063030-1  
 SDE DIESET, RBY, UL



TE Part # 47806-2  
 DIES PIDG 22-16 DIE SET



TE Part # 59300  
 T-HEAD PIDG PG 26-16 ASSY



TE Part # 169400  
 CERTI-LOK FRAME W/O DIES

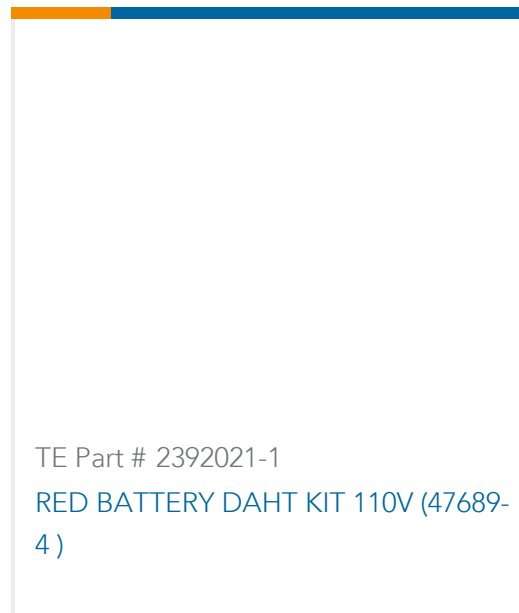
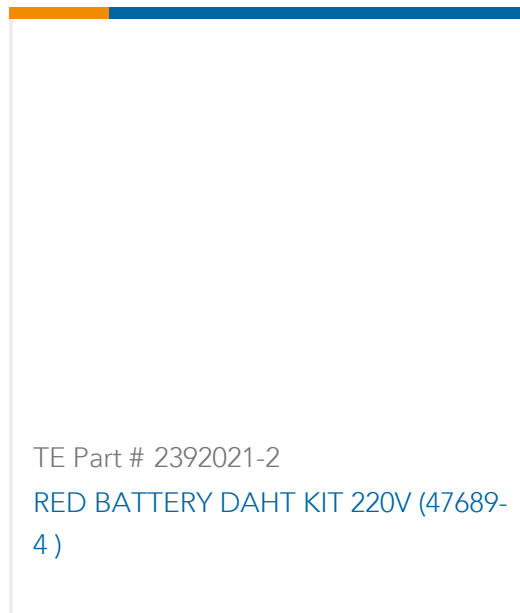

Also in the Series | PIDG

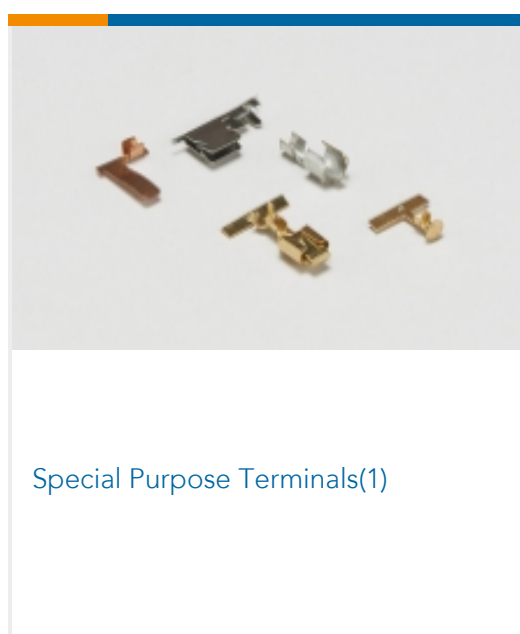
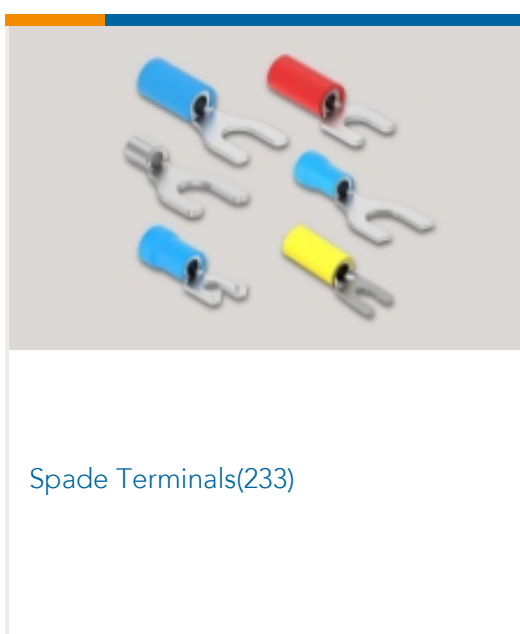
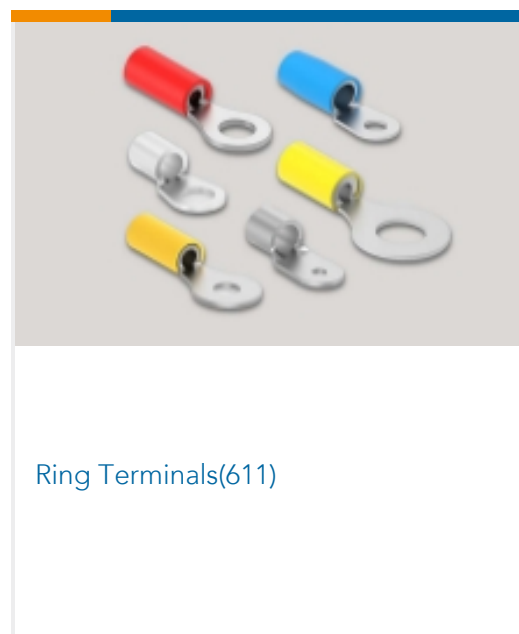
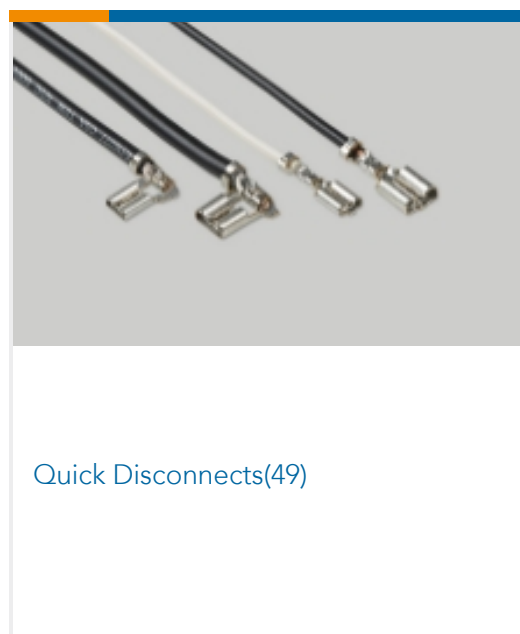
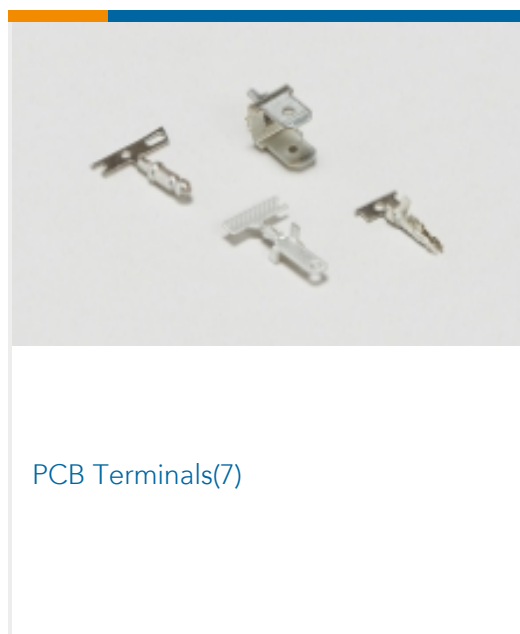
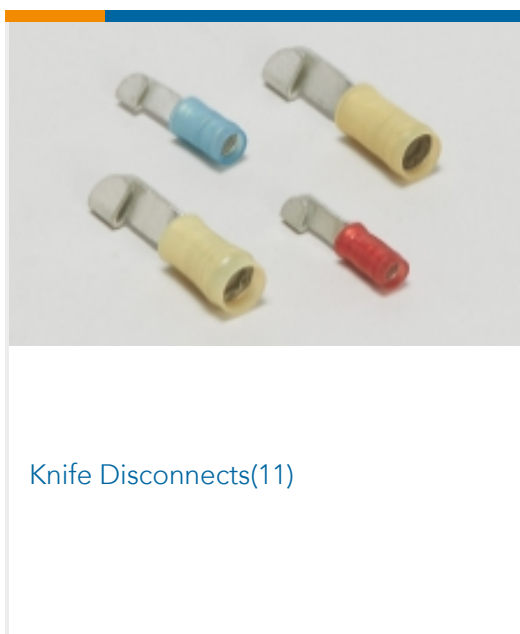
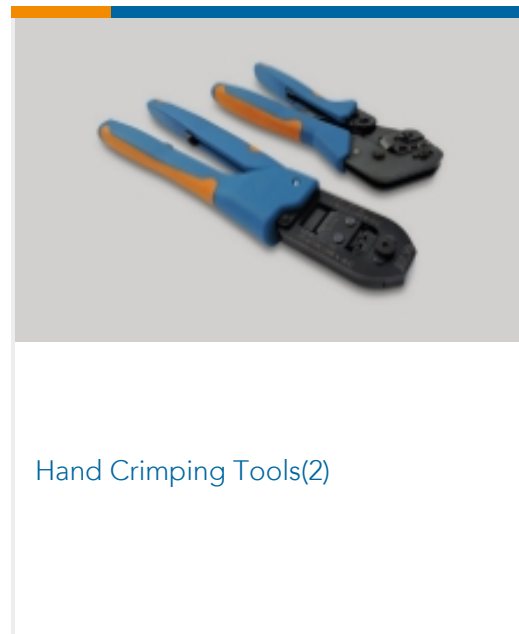
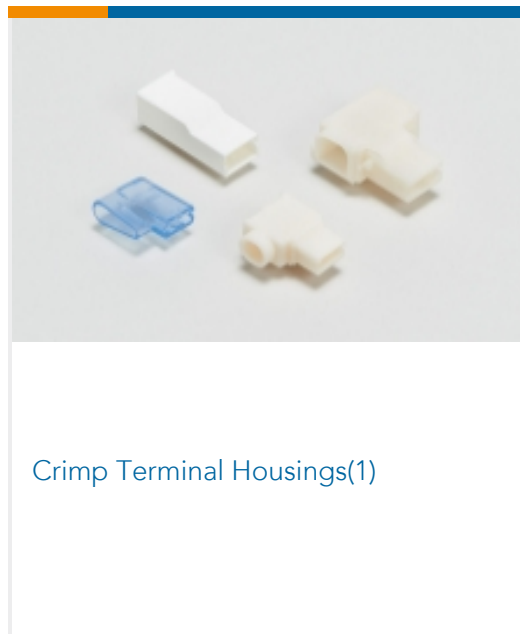
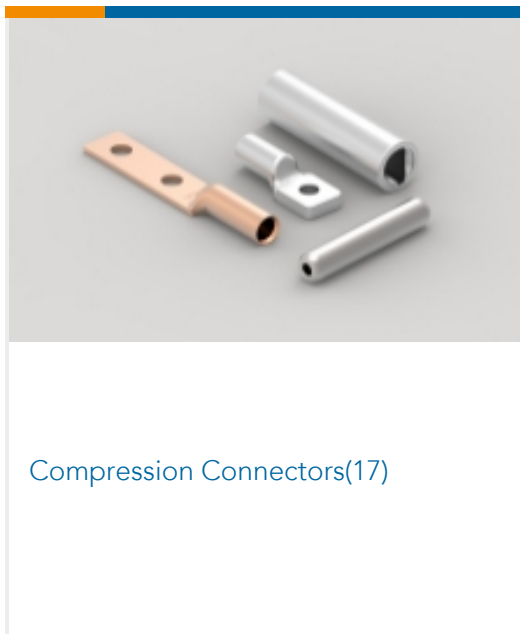

Customers Also Bought



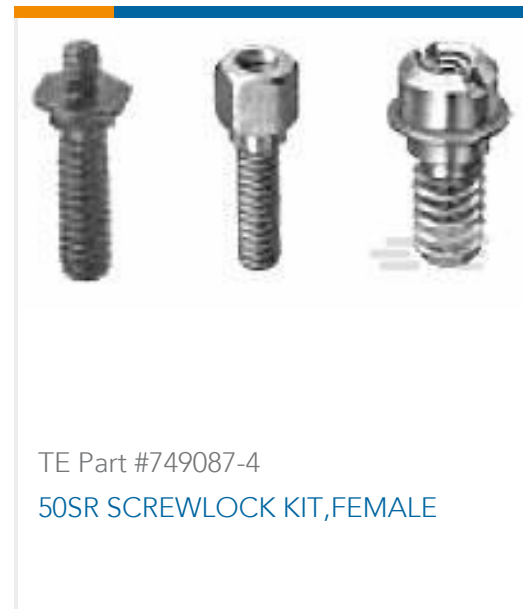
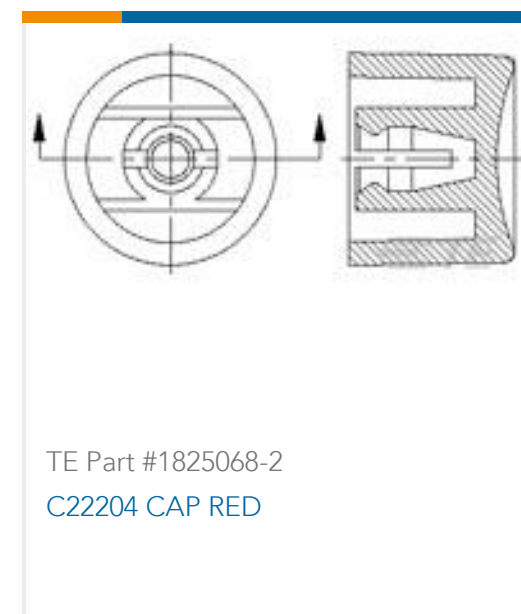

## Documents

### Product Drawings

[PIDG R 22-16 COMM 22-18 MIL 2](#)

English

### CAD Files

[3D PDF](#)

3D

Customer View Model

[ENG\\_CVM\\_CVM\\_328657\\_N.2d\\_dxf.zip](#)

English

Customer View Model

[ENG\\_CVM\\_CVM\\_328657\\_N.3d\\_igs.zip](#)

English

Customer View Model

[ENG\\_CVM\\_CVM\\_328657\\_N.3d\\_stp.zip](#)

English

By downloading the CAD file I accept and agree to the [Terms and Conditions](#) of use.

### Datasheets & Catalog Pages

[PIDG TERMINALS & SPLICES Quick Reference Guide](#)

English

### Product Specifications

[Application Specification](#)

English

### Product Environmental Compliance

[MD\\_328657\\_060320182150\\_dmtec](#)

328657

Closed Ring Tongue Terminal, 22 – 16 AWG, M2 / #2 Stud Size, 2.36 mm [.093 in]  
Stud Diameter, Closed Barrel, Straight, Tin, Partially Insulated, PIDG



English

[MD\\_328657\\_060320182150\\_dmtec](#)

English

---

**Agency Approvals**

[UL Report](#)

English

[UL Report](#)

English