

326802 ✓ ACTIVE

AMPOWER

TE Internal #: 326802

Rectangular Tongue Terminal, 000 AWG, 3/8 Stud Size, 9.91 mm [.39 in] Stud Diameter, Closed Barrel, Straight, Tin, Uninsulated, AMPOWER

[View on TE.com >](#)



Terminals & Splices > Spade Terminals > AMPOWER Terminal, 2 Stud Holes



Spade Terminal Type: **Rectangular Tongue Terminal**

Wire Size: 150500 – 190000 CMA

Stud Size: 3/8

[All AMPOWER Terminal, 2 Stud Holes \(25\)](#)

### Features

#### Product Type Features

Terminal Features	Inspection Slot
Stud Size	3/8
Sealable	No

#### Configuration Features

Number of Holes	2
-----------------	---

#### Body Features

Product Weight	48.534 g
----------------	----------

#### Contact Features

Military Part Class	Class II
Spade Terminal Type	Rectangular Tongue Terminal
Barrel Type	Closed
Terminal Orientation	Straight
Terminal Plating Material	Tin

#### Mechanical Attachment

Wire Insulation Support	Without
-------------------------	---------

#### Dimensions

Wire Size	150500 – 190000 CMA
-----------	---------------------



Stud Diameter	9.91 mm[.39 in]
Tongue Thickness	3.05 mm[.12 in]
Product Length	83.06 mm[3.27 in]
Barrel Inside Diameter	14.63 mm[.576 in]

### Usage Conditions

Insulation Option	Uninsulated
Operating Temperature Range	-55 – 105 °C[-67 – 221 °F]

### Operation/Application

Compatible With Wire Base Material	Copper
Compatible With Wire Plating Material	Tin

### Industry Standards

Government Qualified Terminal	No
-------------------------------	----

### Packaging Features

Packaging Quantity	50
Packaging Method	Box

### Other

Terminals & Splices Comment	Electrodeposited Tin Plate per MIL-T-10727.
-----------------------------	---

## Product Compliance

[For compliance documentation, visit the product page on TE.com>](#)

EU RoHS Directive 2011/65/EU	Compliant
EU ELV Directive 2000/53/EC	Compliant
China RoHS 2 Directive MIIT Order No 32, 2016	No Restricted Materials Above Threshold
EU REACH Regulation (EC) No. 1907/2006	Current ECHA Candidate List: JUNE 2023 (235) Candidate List Declared Against: JUNE 2023 (235) Does not contain REACH SVHC
Halogen Content	Low Halogen - Br, Cl, F, I < 900 ppm per homogenous material. Also BFR/CFR/PVC Free
Solder Process Capability	Not applicable for solder process capability

Product Compliance Disclaimer

This information is provided based on reasonable inquiry of our suppliers and represents our current actual knowledge based on the information they provided. This information is subject to change. The part numbers that TE has identified as EU RoHS compliant have a maximum concentration of 0.1% by weight in homogenous materials for lead, hexavalent chromium, mercury, PBB, PBDE, DBP, BBP, DEHP, DIBP, and 0.01% for cadmium, or qualify for an exemption to these limits as defined in the Annexes of Directive 2011/65/EU (RoHS2). Finished electrical and electronic equipment products will be CE marked as required by Directive 2011/65/EU. Components may not be CE marked. Additionally, the part numbers that TE has identified as EU ELV compliant have a maximum concentration of 0.1% by weight in homogenous materials for lead, hexavalent chromium, and mercury, and 0.01% for cadmium, or qualify for an exemption to these limits as defined in the Annexes of Directive 2000/53/EC (ELV). Regarding the REACH Regulation, the information TE provides on SVHC in articles for this part number is based on the latest European Chemicals Agency (ECHA) 'Guidance on requirements for substances in articles' posted at this URL: <https://echa.europa.eu/guidance-documents/guidance-on-reach>

## Compatible Parts



## Also in the Series | AMPOWER

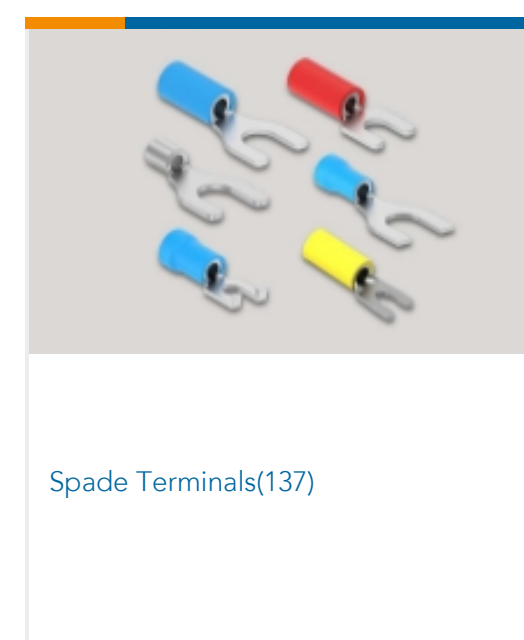
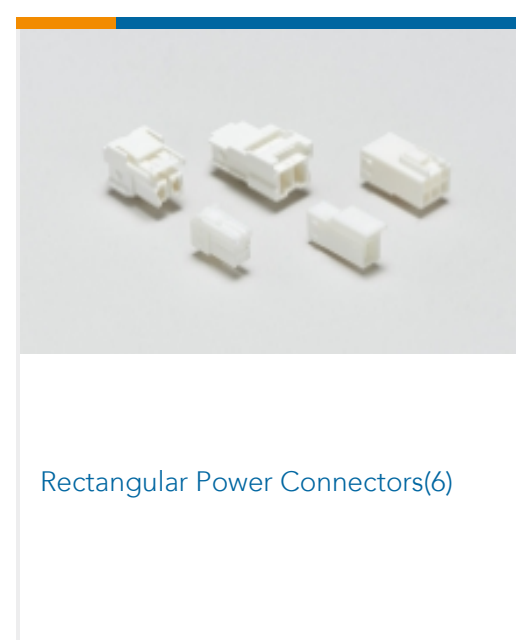
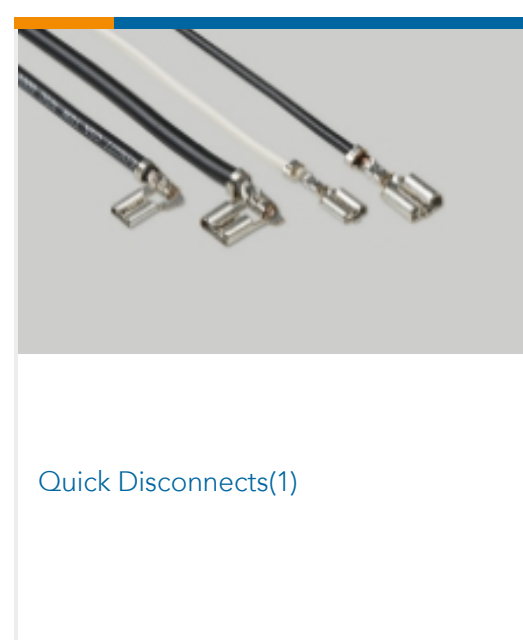
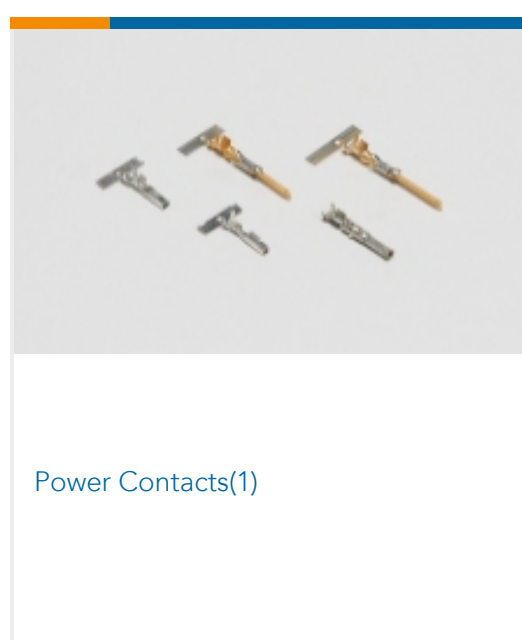
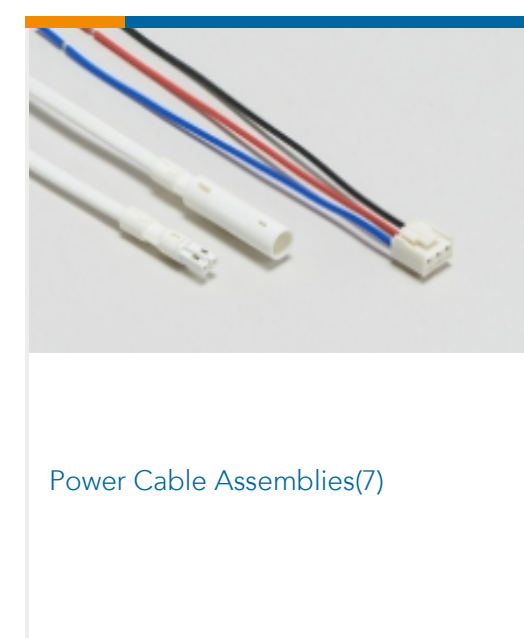
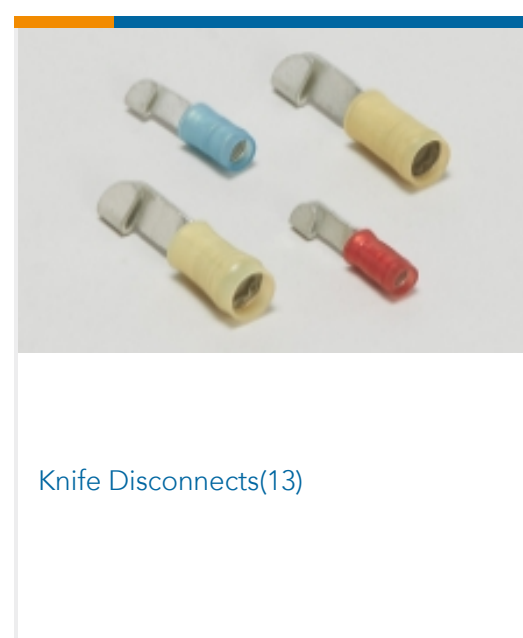
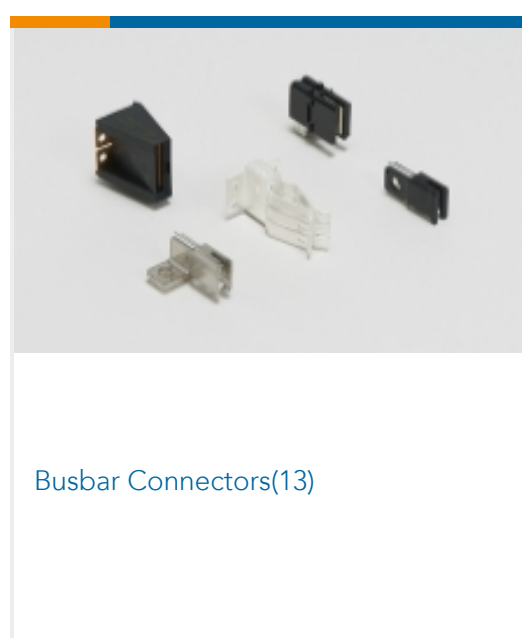



Splices(39)

## Customers Also Bought



TE Part #4575670001  
TMS-SCE Military Grade Sleeves

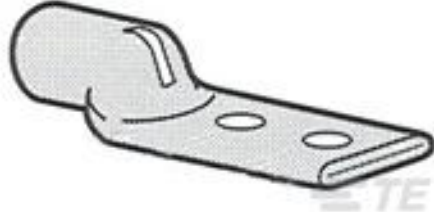

TE Part #326808  
TERMINAL,AMPPOWER 500MCM 3/8



TE Part #1-1418639-5  
2POS MQS REC COD A



TE Part #53682-2  
TERMINAL,AMPPOWER 3/0 1/2



TE Part #F687753001  
ACW0219-1.00-5(NS)

TE Part #8721666001  
DR-25-1/4-0-FAR-10M



TE Part #1337773-2  
50/OHM COAX BNC ELB PLUG ELB P

TE Part #6441606001  
DR-25-1/8-0-10M

TE Part #0591683001  
ACW0219-0.50-5(NS)

## Documents

### Product Drawings

[TERMINAL,AMPPOWER 3/0 3/8](#)

English

### CAD Files

[Customer View Model](#)

[ENG\\_CVM\\_326802\\_T.3d\\_igs.zip](#)

English

[Customer View Model](#)



[ENG\\_CVM\\_326802\\_T.3d\\_stp.zip](#)

English

**Customer View Model**

[ENG\\_CVM\\_326802\\_T.2d\\_dxf.zip](#)

English

**3D PDF**

English

By downloading the CAD file I accept and agree to the [Terms and Conditions](#) of use.

---

### Datasheets & Catalog Pages

[AMPOWER Terminals and Splices Flyer](#)

English

---

### Agency Approvals

[UL Report](#)

English