

325605 ✓ ACTIVE

AMPOWER

TE Internal #: 325605

Rectangular Tongue Terminal, 0000 AWG, M12 / 1/2 Stud Size, 13.08 mm [.515 in] Stud Diameter, Closed Barrel, Straight, Tin, Uninsulated, AMPOWER

[View on TE.com >](#)



Terminals & Splices > Spade Terminals > AMPOWER Lug Crimp Terminal, 1 Stud Hole



Spade Terminal Type: Rectangular Tongue Terminal

Wire Size: 190000 – 231000 CMA

Stud Size: 1/2, M12

[All AMPOWER Lug Crimp Terminal, 1 Stud Hole \(51\)](#)

Features

Product Type Features

Terminal Features	Inspection Slot
Stud Size	1/2, M12
Sealable	No

Configuration Features

Number of Holes	1
-----------------	---

Body Features

Product Weight	44.607 g
----------------	----------

Contact Features

Military Part Class	Class II
Spade Terminal Type	Rectangular Tongue Terminal
Barrel Type	Closed
Terminal Orientation	Straight
Terminal Plating Material	Tin

Mechanical Attachment

Wire Insulation Support	Without
-------------------------	---------

Dimensions

Wire Size	190000 – 231000 CMA
-----------	---------------------



Stud Diameter	13.08 mm[.515 in]
---------------	-------------------

Tongue Thickness	3.3 mm[.13 in]
------------------	----------------

Product Length	62.23 mm[2.45 in]
----------------	-------------------

Barrel Inside Diameter	16.46 mm[.648 in]
------------------------	-------------------

Usage Conditions

Insulation Option	Uninsulated
-------------------	-------------

Operating Temperature Range	-55 – 105 °C[-67 – 221 °F]
-----------------------------	----------------------------

Operation/Application

Compatible With Wire Base Material	Copper
------------------------------------	--------

Compatible With Wire Plating Material	Tin
---------------------------------------	-----

Industry Standards

Government Qualified Terminal	No
-------------------------------	----

Packaging Features

Packaging Quantity	50
--------------------	----

Packaging Method	Box
------------------	-----

Other

Terminals & Splices Comment	Electrodeposited Tin Plate per MIL-T-10727.
-----------------------------	---

Product Compliance

[For compliance documentation, visit the product page on TE.com>](#)

EU RoHS Directive 2011/65/EU	Compliant
------------------------------	-----------

EU ELV Directive 2000/53/EC	Compliant
-----------------------------	-----------

China RoHS 2 Directive MIIT Order No 32, 2016	No Restricted Materials Above Threshold
---	---

EU REACH Regulation (EC) No. 1907/2006	Current ECHA Candidate List: JUNE 2023 (235) Candidate List Declared Against: JUNE 2023 (235) Does not contain REACH SVHC
--	---

Halogen Content	Low Halogen - Br, Cl, F, I < 900 ppm per homogenous material. Also BFR/CFR/PVC Free
-----------------	---

Solder Process Capability	Not applicable for solder process capability
---------------------------	--

Product Compliance Disclaimer

This information is provided based on reasonable inquiry of our suppliers and represents our current actual knowledge based on the information they provided. This information is subject to change. The part numbers that TE has identified as EU RoHS compliant have a maximum concentration of 0.1% by weight in homogenous materials for lead, hexavalent chromium, mercury, PBB, PBDE, DBP, BBP, DEHP, DIBP, and 0.01% for cadmium, or qualify for an exemption to these limits as defined in the Annexes of Directive 2011/65/EU (RoHS2). Finished electrical and electronic equipment products will be CE marked as required by Directive 2011/65/EU. Components may not be CE marked. Additionally, the part numbers that TE has identified as EU ELV compliant have a maximum concentration of 0.1% by weight in homogenous materials for lead, hexavalent chromium, and mercury, and 0.01% for cadmium, or qualify for an exemption to these limits as defined in the Annexes of Directive 2000/53/EC (ELV). Regarding the REACH Regulation, the information TE provides on SVHC in articles for this part number is based on the latest European Chemicals Agency (ECHA) 'Guidance on requirements for substances in articles' posted at this URL: <https://echa.europa.eu/guidance-documents/guidance-on-reach>

Compatible Parts



Also in the Series | AMPOWER

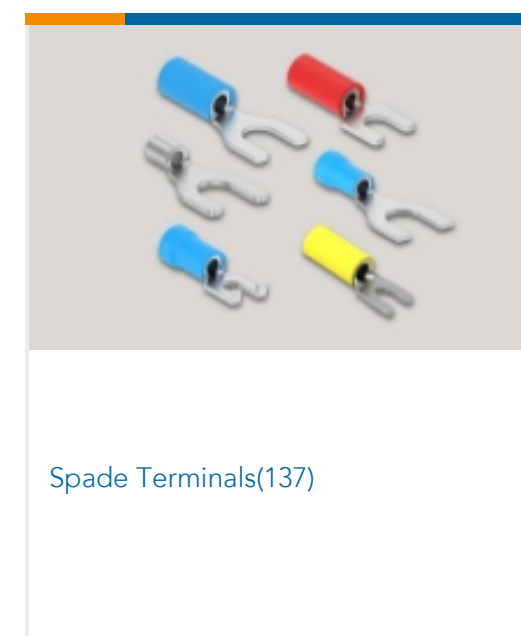
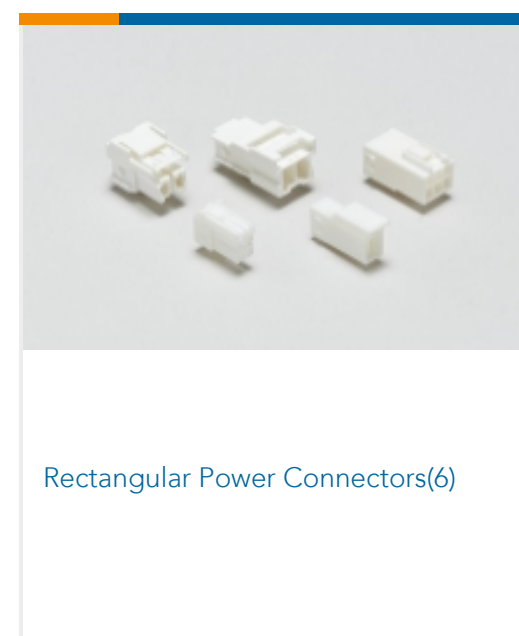
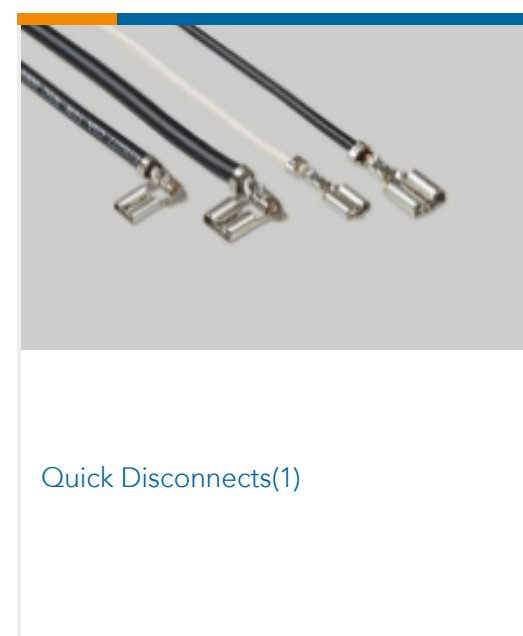
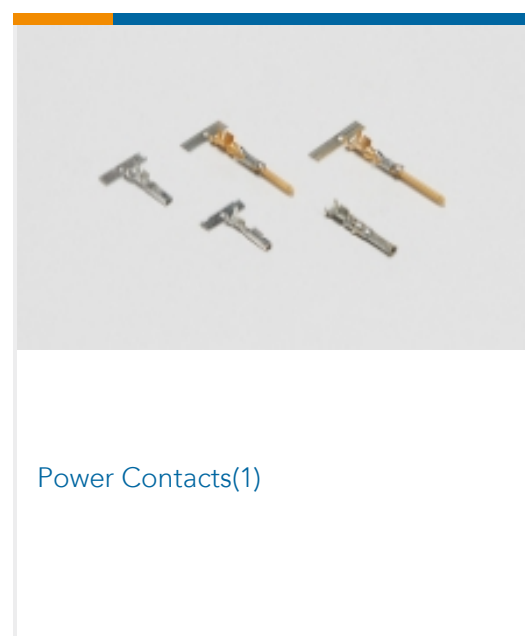
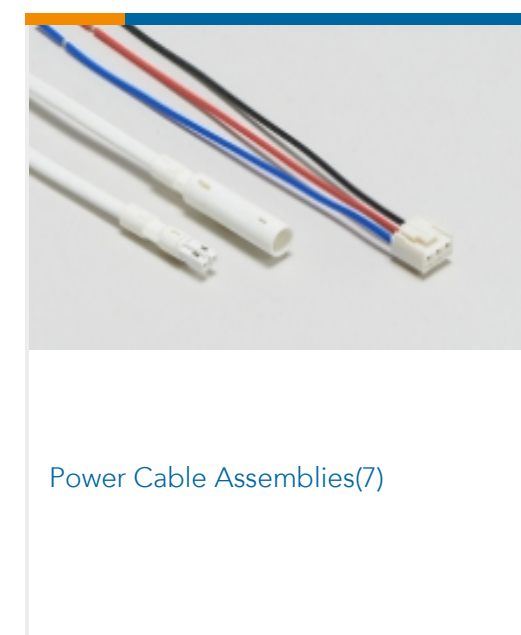
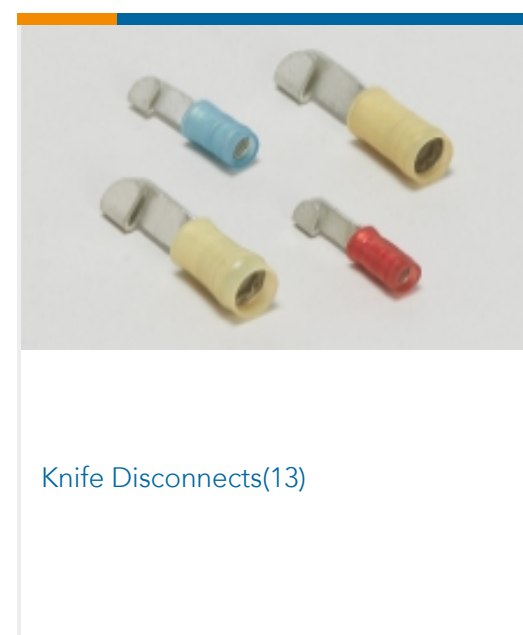
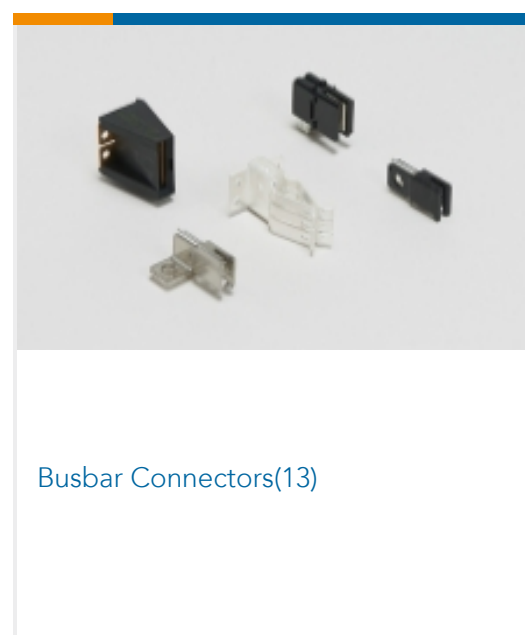



Splices(39)

Customers Also Bought

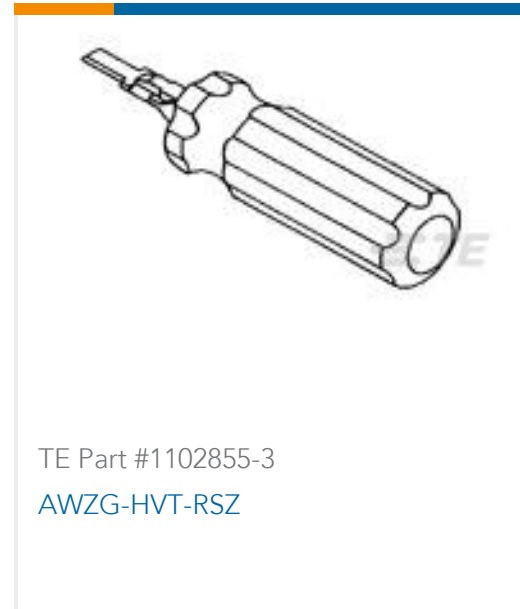
TE Part #35684
TERMINAL,SOLIS R 14-12 6TE Part #1102855-3
AWZG-HVT-RSZTE Part #52010
COPALUM Stranded/Solid: Butt
SplicesTE Part #327175
TERMINAL,SOLIS R 4 1/2TE Part #35135
TERMINAL,SOLIS R 12-10 1/2TE Part #34484
TERMINAL,SOLIS R 14-12 10TE Part #31805
TERMINAL,SOLIS R 12-10 10TE Part #4-1393104-2
KRPA-11DG-110=KRPA

Documents

Product Drawings

[TERMINAL,AMPOWER 4/0 1/2](#)

English

CAD Files

Customer View Model

[ENG_CVM_325605_R.3d_igs.zip](#)

English

Customer View Model

[ENG_CVM_325605_R.3d_stp.zip](#)

English

Customer View Model

[ENG_CVM_325605_R.2d_dxf.zip](#)

English

3D PDF

English

By downloading the CAD file I accept and agree to the [Terms and Conditions](#) of use.



Datasheets & Catalog Pages

[AMPOWER Terminals and Splices Flyer](#)

English

Product Specifications

[Application Specification](#)

English

Product Environmental Compliance

[TE Material Declaration](#)

English

Instruction Sheets

[Instruction Sheet \(U.S.\)](#)

English

Agency Approvals

[UL Report](#)

English