

31895 ✓ ACTIVE

PIDG

TE Internal #: 31895

Closed Ring Tongue Terminal, 22 AWG, 5/16 / M8 Stud Size, 7.92 mm [.312 in] Stud Diameter, Closed Barrel, Straight, Tin, Partially Insulated, PIDG

[View on TE.com >](#)



Terminals & Splices > Ring Terminals > PIDG Ring Tongue Terminals

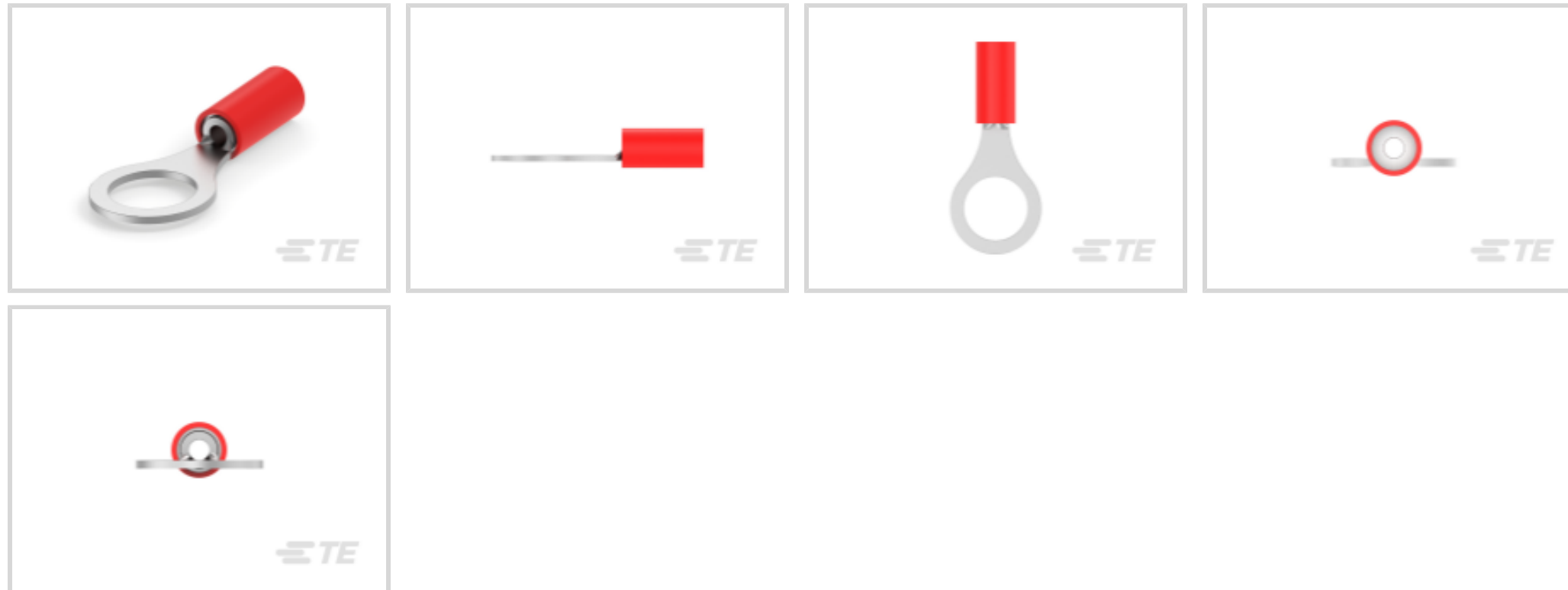

Ring Terminal Product Type: Closed Ring Tongue Terminal

Wire Size: 509 – 3260 CMA

Stud Size: 5/16, M8

[All PIDG Ring Tongue Terminals \(418\)](#)

Features

Product Type Features

Ring Terminal Product Type	Closed Ring Tongue Terminal
Stud Size	5/16, M8
Sealable	No
Wire Insulation Support Retention Type	Insulation Support

Configuration Features

Number of Holes	1
-----------------	---

Electrical Characteristics

Voltage Rating	300 V
----------------	-------

Body Features

Product Weight	1.081 g
Insulation Sleeve Color	Red
Stripe Color	Red

Contact Features

--	--



Military Part Class	Class I
Barrel Type	Closed
Terminal Orientation	Straight
Terminal Plating Material	Tin

Mechanical Attachment

Wire Insulation Support	With
-------------------------	------

Dimensions

Wire Size	509 – 3260 CMA
Stud Diameter	7.92 mm [.312 in]
Tongue Thickness	.84 mm [.033 in]
Product Length	27.38 mm [1.078 in]
Compatible Insulation Diameter (Max)	3.56 mm [.14 in]
Compatible Insulation Diameter Range	2.67 – 3.56 mm [.105 – .14 in]

Usage Conditions

Insulation Option	Partially Insulated
Operating Temperature Range	105 °C [221 °F]

Operation/Application

Compatible With Wire Base Material	Copper
Compatible With Wire Plating Material	Tin

Industry Standards

Government Qualified Terminal	Yes
-------------------------------	-----

Packaging Features

Packaging Quantity	1000
Packaging Method	Loose Piece

Product Compliance

[For compliance documentation, visit the product page on TE.com>](#)

EU RoHS Directive 2011/65/EU	Compliant
EU ELV Directive 2000/53/EC	Compliant
China RoHS 2 Directive MIIT Order No 32, 2016	No Restricted Materials Above Threshold
EU REACH Regulation (EC) No. 1907/2006	Current ECHA Candidate List: JUNE 2023 (235)



Candidate List Declared Against: JUNE 2023 (235)

Does not contain REACH SVHC

Halogen Content

Low Halogen - Br, Cl, F, I < 900 ppm per homogenous material. Also BFR/CFR/PVC Free

Solder Process Capability

Not applicable for solder process capability

Product Compliance Disclaimer

This information is provided based on reasonable inquiry of our suppliers and represents our current actual knowledge based on the information they provided. This information is subject to change. The part numbers that TE has identified as EU RoHS compliant have a maximum concentration of 0.1% by weight in homogenous materials for lead, hexavalent chromium, mercury, PBB, PBDE, DBP, BBP, DEHP, DIBP, and 0.01% for cadmium, or qualify for an exemption to these limits as defined in the Annexes of Directive 2011/65/EU (RoHS2). Finished electrical and electronic equipment products will be CE marked as required by Directive 2011/65/EU. Components may not be CE marked. Additionally, the part numbers that TE has identified as EU ELV compliant have a maximum concentration of 0.1% by weight in homogenous materials for lead, hexavalent chromium, and mercury, and 0.01% for cadmium, or qualify for an exemption to these limits as defined in the Annexes of Directive 2000/53/EC (ELV). Regarding the REACH Regulation, the information TE provides on SVHC in articles for this part number is based on the latest European Chemicals Agency (ECHA) 'Guidance on requirements for substances in articles' posted at this URL: <https://echa.europa.eu/guidance-documents/guidance-on-reach>

Compatible Parts

TE Part # 59824-1
TETRA-CRIMP PIDG PG FASTON 22-10 ASSY

TE Part # 47386
DAHT PG PIDG 26-16 ASSY

TE Part # 47386-4
DAHT PG PIDG 26-16 ASSY

TE Part # 59250
T-HEAD PIDG 26-14 ASSY

TE Part # 58423-1
DIE, RBY IS9252

TE Part # 58433-3
PRO CR ASSY, RBY IS9252

TE Part # 525690
DAHT PG PIDG 20-18 ASSY

TE Part # 539691-2
ERGO DIE R.B.Y

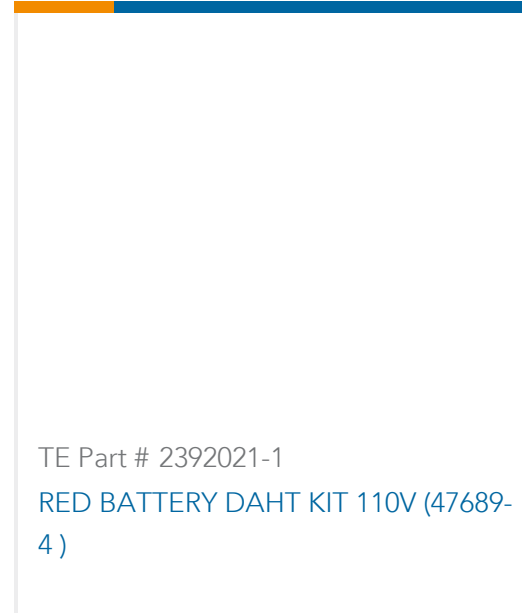
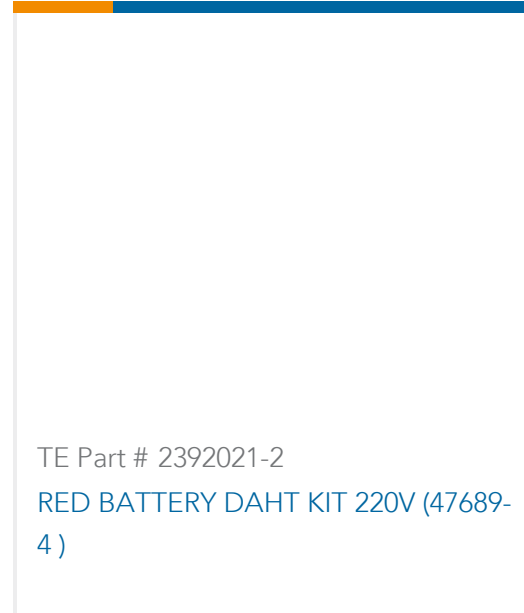

Also in the Series | PIDG

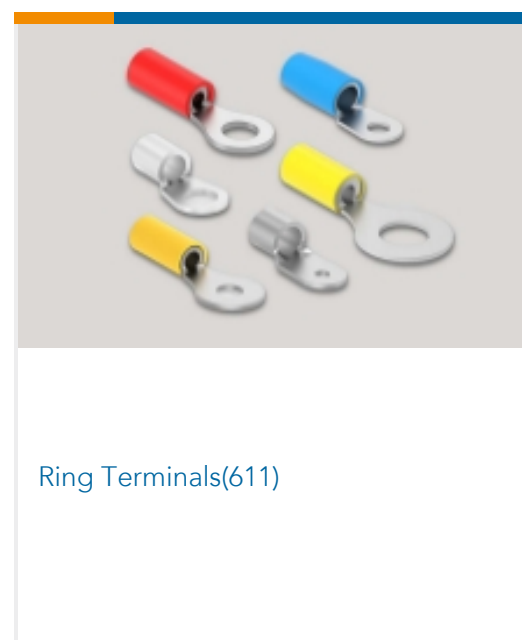
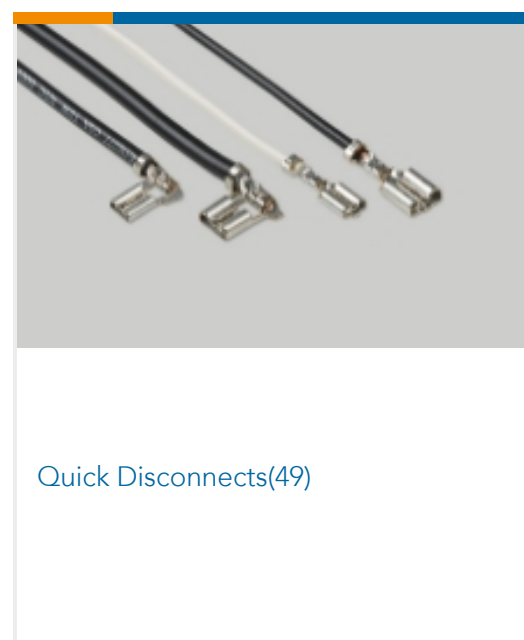
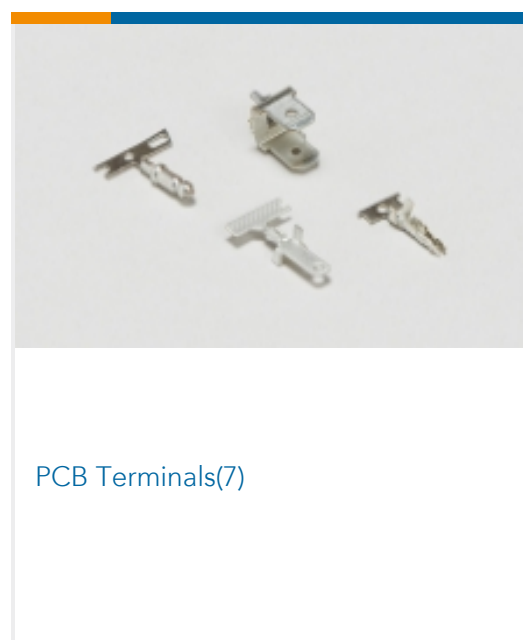
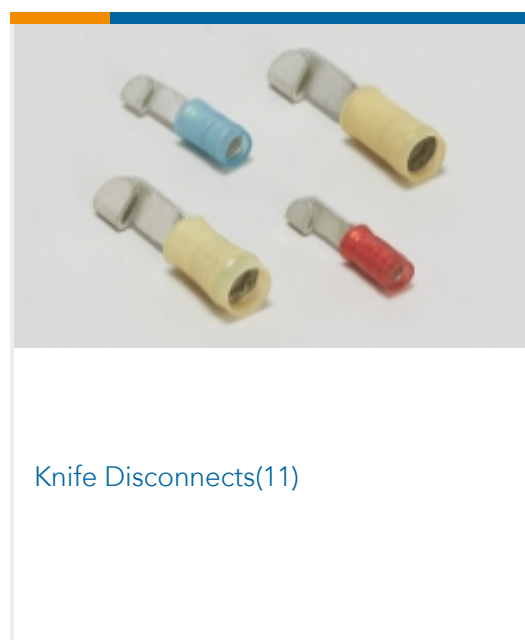
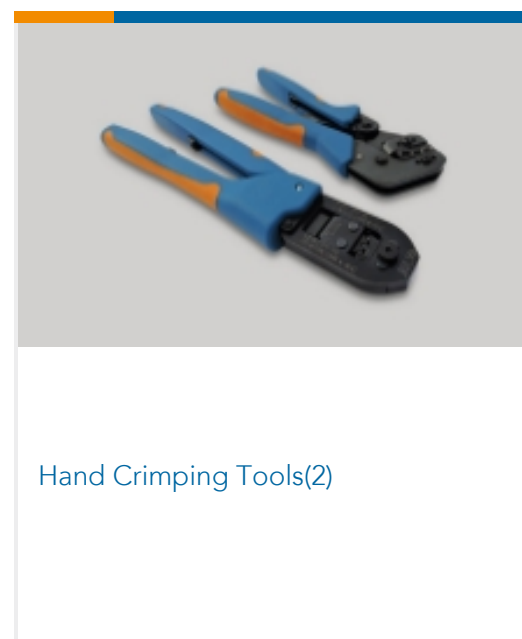
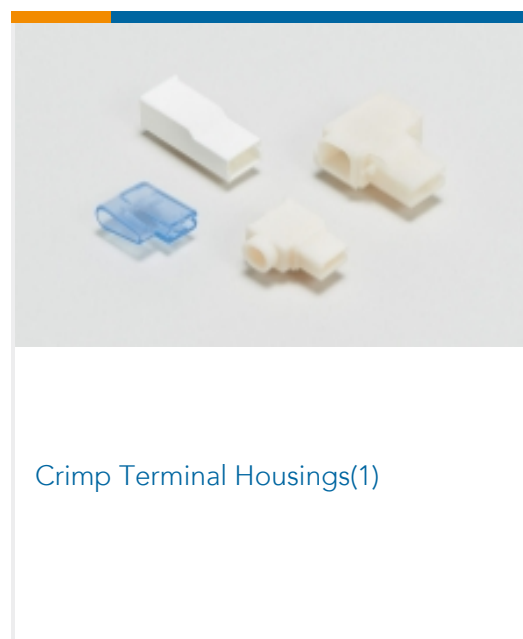
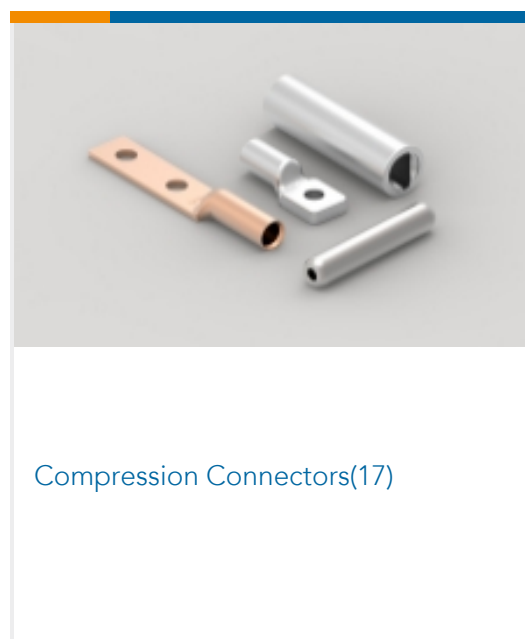

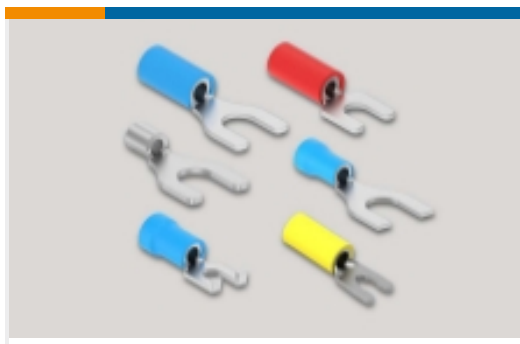

Spade Terminals(233)



Special Purpose Terminals(1)



Splices(46)

Customers Also Bought



TE Part #3-644043-4
04P MTA100 CONN ASSY LF

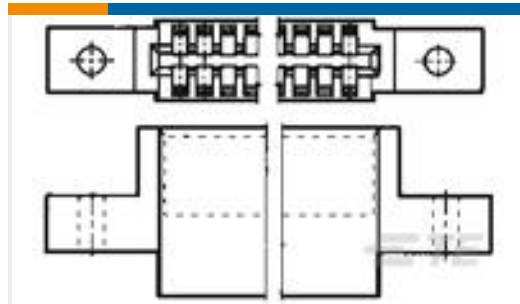

TE Part #2-583718-7
TW-LEAF CRP HSG 32 POS 100C/L

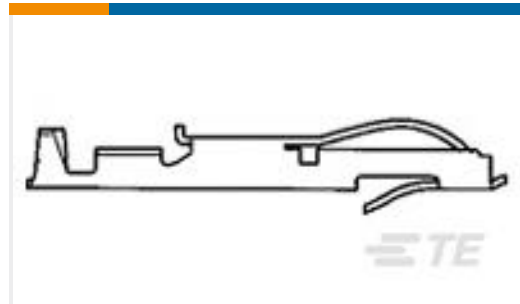

TE Part #583853-2
CONT.CRP.SNAP TW.LF.STRIP



TE Part #E21385-000
B-155-06

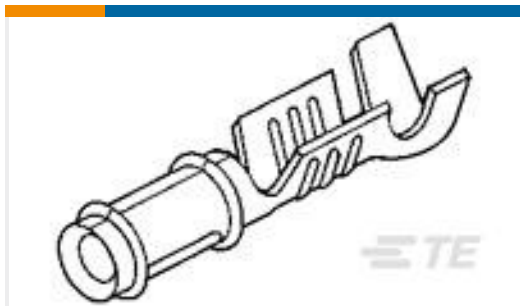

TE Part #170136-2
1.47MM DIA PIN RECEPT STRIP



TE Part #ZPF000000000104061
DS 07-7 S-A086



TE Part #1-1414415-0
RESOLVER V23401-U6119-B609

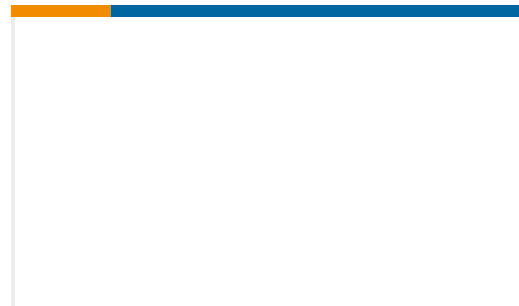

TE Part #AAC7879-00
PE93-10.0-T

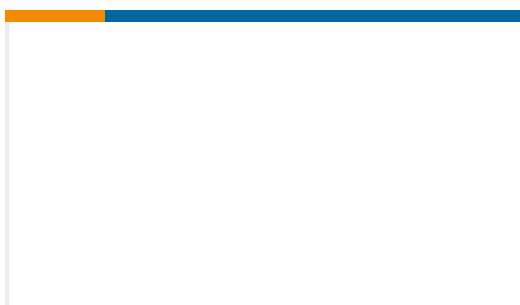

TE Part #AAC7882-00
PE93-12.5-T

Documents

Product Drawings

[PIDG R 22-16COMM 22-18MIL 5/16](#)

English

CAD Files

Customer View Model

[ENG_CVM_CVM_31895_W.2d_dxf.zip](#)

English

[3D PDF](#)



3D

Customer View Model

[ENG_CVM_CVM_31895_W.3d_igs.zip](#)

English

Customer View Model

[ENG_CVM_CVM_31895_W.3d_stp.zip](#)

English

By downloading the CAD file I accept and agree to the [Terms and Conditions](#) of use.

Datasheets & Catalog Pages

[PIDG TERMINALS & SPLICES Quick Reference Guide](#)

English

Product Specifications

[Application Specification](#)

English

Product Environmental Compliance

[MD_31895_10312017848_dmtec](#)

English

[MD_31895_10312017848_dmtec](#)

English

Agency Approvals

[UL Report](#)

English

[UL Report](#)

English