



Application Tooling > Insertion & Extraction Tools



Insertion & Extraction Tool Type: **Contact Extraction**

Insertion & Extraction Tool Application: **Contact-to-Housing**

## Features

### Product Type Features

Insertion & Extraction Tool Type	Contact Extraction
Insertion & Extraction Tool Application	Contact-to-Housing

## Product Compliance

[For compliance documentation, visit the product page on TE.com>](#)

EU RoHS Directive 2011/65/EU	Out of Scope
EU ELV Directive 2000/53/EC	Out of Scope
China RoHS 2 Directive MIIT Order No 32, 2016	Not reviewed for China RoHS compliance
EU REACH Regulation (EC) No. 1907/2006	Current ECHA Candidate List: JAN 2023 (233) Candidate List Declared Against: JUL 2021 (219) Does not contain REACH SVHC
Halogen Content	Not Yet Reviewed for halogen content
Solder Process Capability	Not applicable for solder process capability

### Product Compliance Disclaimer

This information is provided based on reasonable inquiry of our suppliers and represents our current actual knowledge based on the information they provided. This information is subject to change. The part numbers that TE has identified as EU RoHS compliant have a maximum concentration of 0.1% by weight in homogenous materials for lead, hexavalent chromium, mercury, PBB, PBDE, DBP, BBP, DEHP, DIBP, and 0.01% for cadmium, or qualify for an exemption to these limits as defined in the Annexes of Directive 2011/65/EU (RoHS2). Finished electrical and electronic equipment products will be CE marked as required by Directive 2011/65/EU. Components may not be CE marked. Additionally, the part numbers that TE has identified as EU ELV compliant have a maximum concentration of 0.1% by weight in homogenous materials for lead, hexavalent chromium, and mercury, and 0.01% for cadmium, or qualify for an exemption to these limits as defined in the Annexes of Directive 2000/53/EC (ELV). Regarding the REACH Regulation, the information TE provides

on SVHC in articles for this part number is based on the latest European Chemicals Agency (ECHA) 'Guidance on requirements for substances in articles' posted at this URL: <https://echa.europa.eu/guidance-documents/guidance-on-reach>

## Compatible Parts



TE Part # 770144-1  
.093 CP&S SOK PTPBR L/P 20-14



TE Part # 770147-1  
.093 CP&S PIN PTPBR LP 24-18



TE Part # 350416-1  
.093 COMM P&S PIN 14-20 PTPBR



TE Part # 350415-1  
.093 COMM P&S SOK 14-20 PTPBR



TE Part # 350418-1  
.093 COMM P&S PIN 18-24 PTPBR



TE Part # 350417-1  
.093 COMM P&S SOK 18-24 PTPBR



TE Part # 350415-5  
.093 COMM P&S SOK 20-14 AUBR



TE Part # 770146-1  
.093 CP&S SOK PTPBR LP 24-18



TE Part # 350416-5  
.093 COMM P&S PIN AU/NI/BR



TE Part # 770144-5  
.093 CP&S SOC AUBR L/P 20-14



TE Part # 350415-6  
.093 COMM P&S SOK 14-20 PTPHBZ



TE Part # 350417-5  
.093 COMM P&S SOK AU/NI/BR



TE Part # 770145-1  
.093 COMM P&S PIN PTPBR LP



TE Part # 770145-5  
.093 CP&S PIN AUBR LP 20-14



TE Part # 770146-5  
.093 CP&S SOK AUBR LP 24-18



TE Part # 770147-5  
.093 CP&S PIN AUBR LP 24-18



TE Part # 350417-3  
.093 COMM P&S SOK 18-24 AUNIBR



TE Part # 350418-5  
.093 COMM P&S PIN AU/NI/BR



TE Part # 770144-6  
.093 CP&S SOC PTPPHBZ LP 20-14

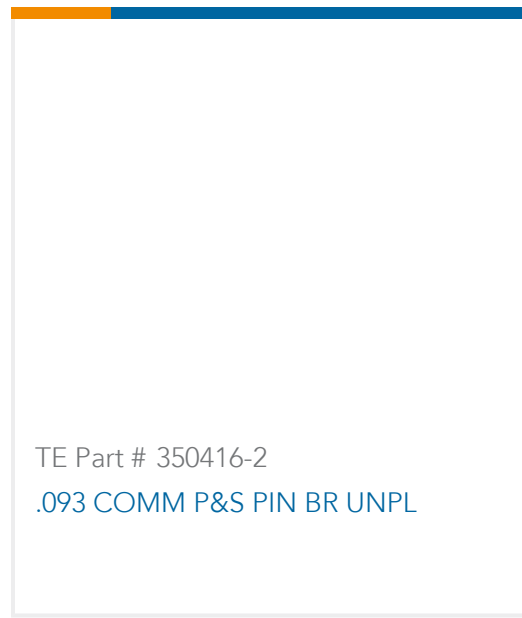

TE Part # 350416-2  
.093 COMM P&S PIN BR UNPL

## Also in the Series | Commercial Pin and Socket Connectors

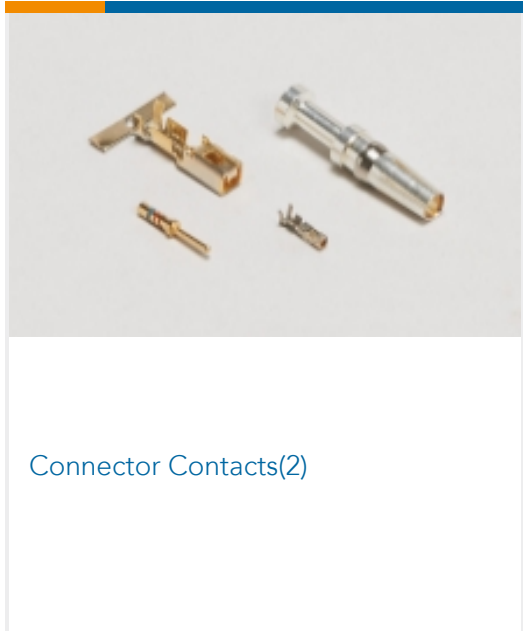

Connector Contacts(2)



Crimp Wire Pins, Tabs & Ferrules(1)

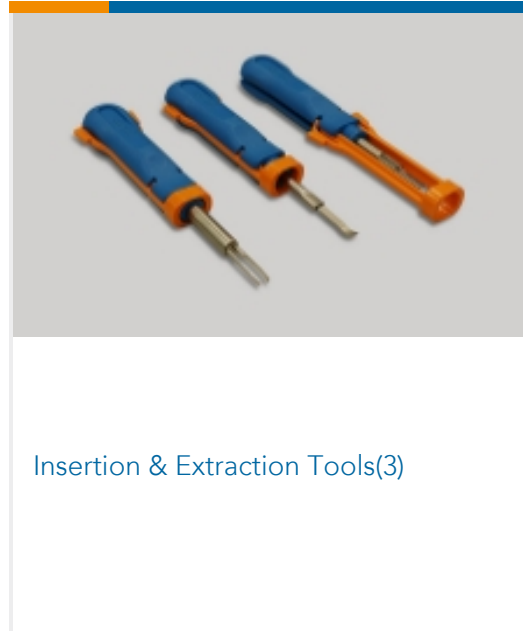

Insertion & Extraction Tools(3)

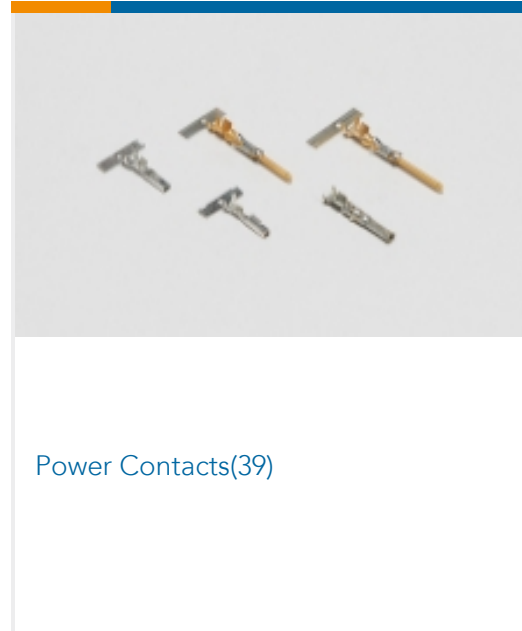

Power Contacts(39)

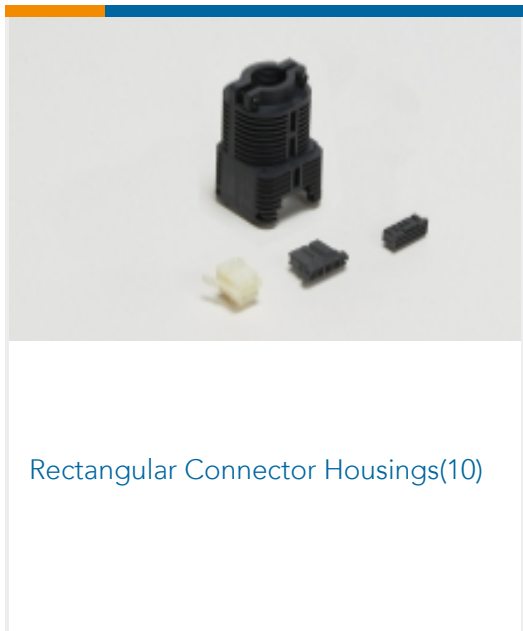

Rectangular Connector Housings(10)



Rectangular Power Connectors(84)

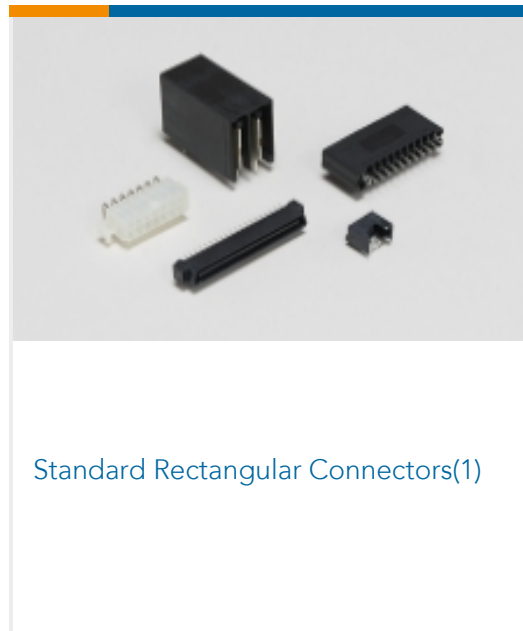

Standard Rectangular Connectors(1)

## Customers Also Bought



TE Part #91503-1  
CCII AMPLIMITE 20 DF PIN SKT 28-20 ASSY



TE Part #91519-1  
CCII TYPE III+ PIN SKT 18-14 ASSY

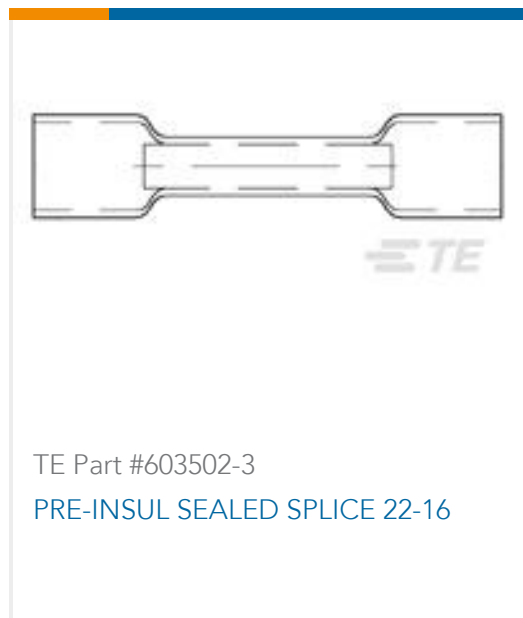

TE Part #603502-3  
PRE-INSUL SEALED SPLICE 22-16



TE Part #770083-1  
05P .093 COMM P&S RECPT HSG



TE Part #770084-1  
05P .093 COMM P&S PLUG HSG



TE Part #926298-7  
UNIVERSAL MATE-N-LOK 4 WAY PLUG



TE Part #91505-1  
CCII TYPE III+ 24-16 ASSY



TE Part #1742898-1  
AMVAR SPLC 10M-22M 0295 TPBR

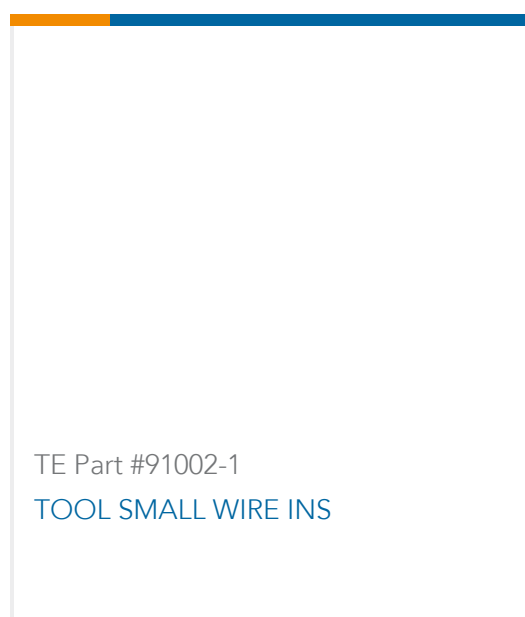

## Documents

### Instruction Sheets

[Instruction Sheet \(U.S.\)](#)

English