

316455-1 ✓ ACTIVE

MATE-N-LOK | Mini-Universal MATE-N-LOK

TE Internal #: 316455-1

Cable Clamp, 9 Position, UL 94V-0, Mini-Universal MATE-N-LOK

[View on TE.com >](#)



Connectors > Connector Accessories > Connector Strain Relief



Strain Relief Accessory Type: **Cable Clamp**

Number of Positions: **9**

UL Flammability Rating: **UL 94V-0**

Packaging Method: **Bag**

Packaging Quantity: **500**

Features

Product Type Features

Strain Relief Accessory Type	Cable Clamp
------------------------------	-------------

Configuration Features

Number of Positions	9
---------------------	---

Usage Conditions

Operating Temperature Range	-20 – 105 °C[-4 – 221 °F]
-----------------------------	---------------------------

Industry Standards

UL Flammability Rating	UL 94V-0
------------------------	----------

Packaging Features

Packaging Method	Bag
------------------	-----

Packaging Quantity	500
--------------------	-----

Product Compliance

[For compliance documentation, visit the product page on TE.com>](#)

EU RoHS Directive 2011/65/EU	Compliant
------------------------------	-----------

EU ELV Directive 2000/53/EC	Compliant
-----------------------------	-----------

China RoHS 2 Directive MIIT Order No 32, 2016	No Restricted Materials Above Threshold
EU REACH Regulation (EC) No. 1907/2006	Current ECHA Candidate List: JUNE 2023 (235) Candidate List Declared Against: JUNE 2023 (235) Does not contain REACH SVHC
Halogen Content	Not Low Halogen - contains Br or Cl > 900 ppm.
Solder Process Capability	Not applicable for solder process capability

Product Compliance Disclaimer

This information is provided based on reasonable inquiry of our suppliers and represents our current actual knowledge based on the information they provided. This information is subject to change. The part numbers that TE has identified as EU RoHS compliant have a maximum concentration of 0.1% by weight in homogenous materials for lead, hexavalent chromium, mercury, PBB, PBDE, DBP, BBP, DEHP, DIBP, and 0.01% for cadmium, or qualify for an exemption to these limits as defined in the Annexes of Directive 2011/65/EU (RoHS2). Finished electrical and electronic equipment products will be CE marked as required by Directive 2011/65/EU. Components may not be CE marked. Additionally, the part numbers that TE has identified as EU ELV compliant have a maximum concentration of 0.1% by weight in homogenous materials for lead, hexavalent chromium, and mercury, and 0.01% for cadmium, or qualify for an exemption to these limits as defined in the Annexes of Directive 2000/53/EC (ELV). Regarding the REACH Regulation, the information TE provides on SVHC in articles for this part number is based on the latest European Chemicals Agency (ECHA) 'Guidance on requirements for substances in articles' posted at this URL: <https://echa.europa.eu/guidance-documents/guidance-on-reach>

Compatible Parts



TE Part # 172161-1
9 CIR UNIV M-N-L CAP



TE Part # 1-172161-9
MINI UNIVERSAL M-N-L CAP 9P



TE Part # 794370-1
08P MINI UMNL STR RELIEF HNGD

Also in the Series | Mini-Universal MATE-N-LOK



Connector Caps & Covers(2)

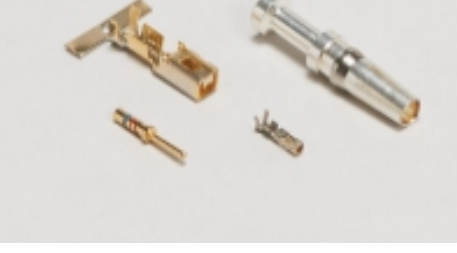

Connector Contacts(8)



Connector Seals & Cavity Plugs(17)



Connector Strain Relief(2)



Insertion & Extraction Tools(1)

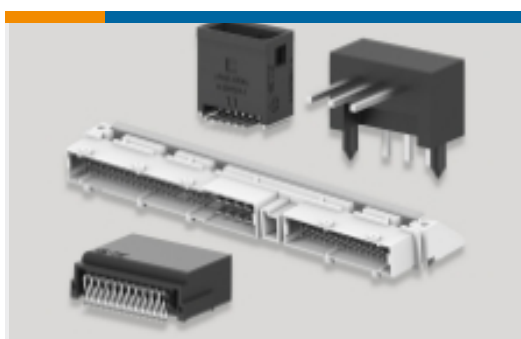

PCB Headers & Receptacles(1)

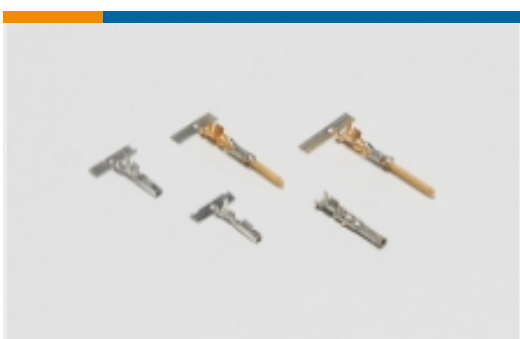

Power Contacts(84)

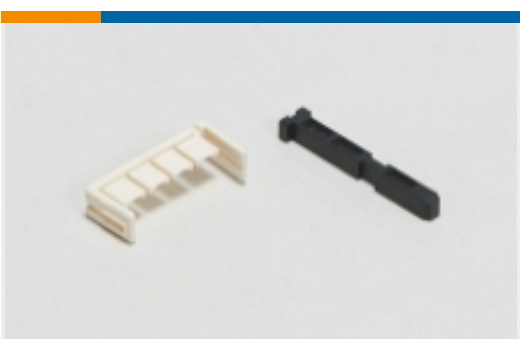

Rectangular Connector Keying Plugs(2)



Rectangular Connector Locking(2)



Rectangular Power Connectors(244)

Customers Also Bought

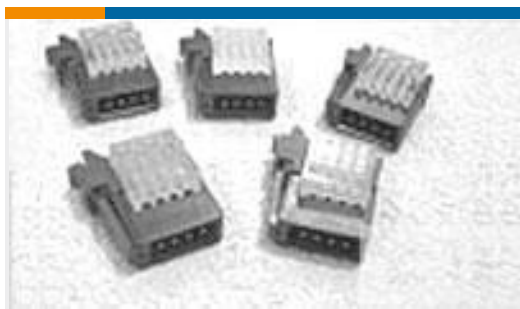

TE Part #3-1473562-4
RITS CONN. PLUG ASSY 4P ORANGE



TE Part #172161-1
9 CIR UNIV M-N-L CAP

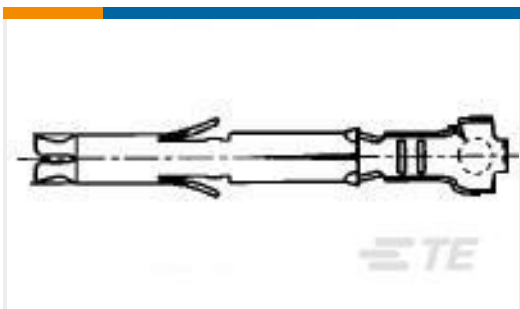

TE Part #170365-1
MINI UNIVERSAL M-N-L SOCKET LP

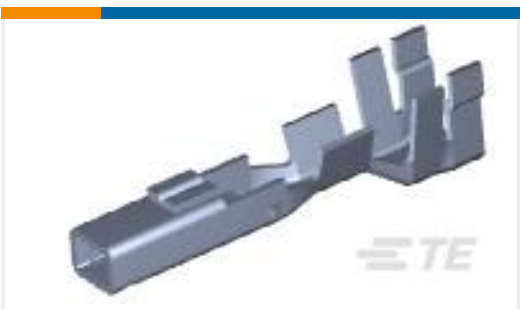

TE Part #179592-1
AMP POWER D/LOCK REC CONT. LP



TE Part #170892-1
187 FASTON HSG.,REC.,NATURAL

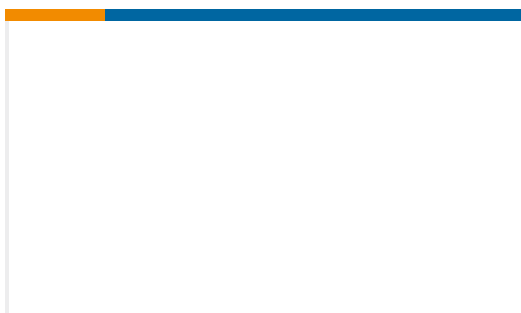

TE Part #2260862-2
F07 APF CABLE ASSY 1M

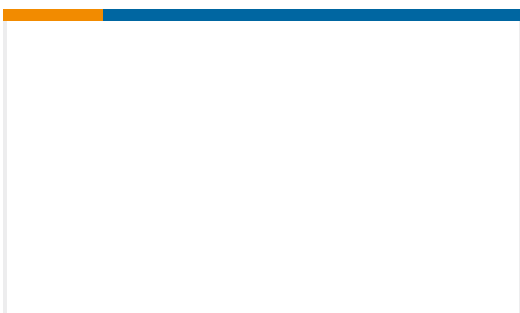

TE Part #1-2260862-0
F07 APF CABLE ASSY 0.15M

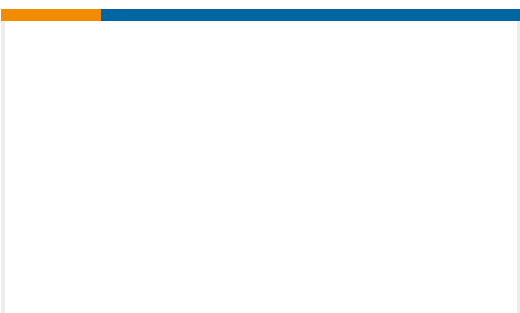

TE Part #2260862-1
F07 APF CABLE ASSY 0.5M

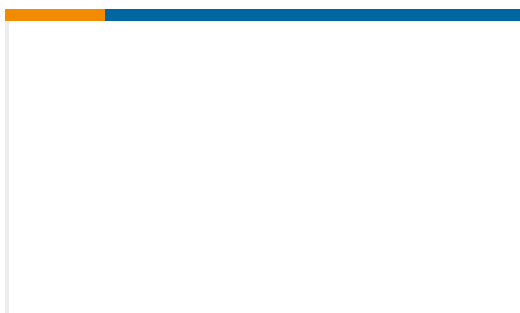

TE Part #1-2260862-1
F07 APF CABLE ASSY 0.3M

Documents



CAD Files

3D PDF

3D

Customer View Model

[ENG_CVM_CVM_316455-1_A_c-316455-1-a.2d_dxf.zip](#)

English

Customer View Model

[ENG_CVM_CVM_316455-1_A_c-316455-1-a.3d_igs.zip](#)

English

Customer View Model

[ENG_CVM_CVM_316455-1_A_c-316455-1-a.3d_stp.zip](#)

English

By downloading the CAD file I accept and agree to the [Terms and Conditions](#) of use.

Datasheets & Catalog Pages

[SOFT_SHELL_PIN_AND_SOCKET_CONNECTORS_CATALOG](#)

English

Product Specifications

[Application Specification](#)

English

Product Environmental Compliance

[TE Material Declaration](#)

English