



Terminals & Splices > Ring Terminals



Ring Terminal Product Type: Closed Ring Tongue Terminal

Wire Size: 509 – 3260 CMA

Stud Size: #10

### Features

#### Product Type Features

Ring Terminal Product Type	Closed Ring Tongue Terminal
Stud Size	#10
Sealable	No
Wire Insulation Support Retention Type	Non-Insulation Support

#### Configuration Features

Number of Holes	1
-----------------	---

#### Body Features

Product Weight	.567 g
----------------	--------

#### Contact Features

Barrel Type	Closed
Terminal Orientation	Straight
Terminal Plating Material	Tin

#### Mechanical Attachment

Wire Insulation Support	Without
-------------------------	---------

#### Dimensions



Wire Size	509 – 3260 CMA
Stud Diameter	5 mm [.197 in]
Tongue Thickness	.79 mm [.031 in]
Product Length	15.77 mm [.621 in]
Barrel Inside Diameter	1.65 mm [.065 in]

### Usage Conditions

Insulation Option	Uninsulated
Operating Temperature Range	170 °C [338 °F]

### Operation/Application

Compatible With Wire Base Material	Copper
Compatible With Wire Plating Material	Tin

### Industry Standards

Government Qualified Terminal	No
-------------------------------	----

### Packaging Features

Packaging Quantity	1000
Packaging Method	Loose Piece

### Other

Line	Budget
------	--------

## Product Compliance

[For compliance documentation, visit the product page on TE.com>](#)

EU RoHS Directive 2011/65/EU	Compliant
EU ELV Directive 2000/53/EC	Compliant
China RoHS 2 Directive MIIT Order No 32, 2016	No Restricted Materials Above Threshold
EU REACH Regulation (EC) No. 1907/2006	Current ECHA Candidate List: JUNE 2023 (235) Candidate List Declared Against: JUNE 2023 (235) Does not contain REACH SVHC
Halogen Content	Low Halogen - Br, Cl, F, I < 900 ppm per homogenous material. Also BFR/CFR/PVC Free
Solder Process Capability	Not applicable for solder process capability

Product Compliance Disclaimer

This information is provided based on reasonable inquiry of our suppliers and represents our current actual knowledge based on the information they provided. This information is subject to change. The part numbers that TE has identified as EU RoHS compliant have a maximum concentration of 0.1% by weight in homogenous materials for lead, hexavalent chromium, mercury, PBB, PBDE, DBP, BBP, DEHP, DIBP, and 0.01% for cadmium, or qualify for an exemption to these limits as defined in the Annexes of Directive 2011/65/EU (RoHS2). Finished electrical and electronic equipment products will be CE marked as required by Directive 2011/65/EU. Components may not be CE marked. Additionally, the part numbers that TE has identified as EU ELV compliant have a maximum concentration of 0.1% by weight in homogenous materials for lead, hexavalent chromium, and mercury, and 0.01% for cadmium, or qualify for an exemption to these limits as defined in the Annexes of Directive 2000/53/EC (ELV). Regarding the REACH Regulation, the information TE provides on SVHC in articles for this part number is based on the latest European Chemicals Agency (ECHA) 'Guidance on requirements for substances in articles' posted at this URL: <https://echa.europa.eu/guidance-documents/guidance-on-reach>

## Compatible Parts

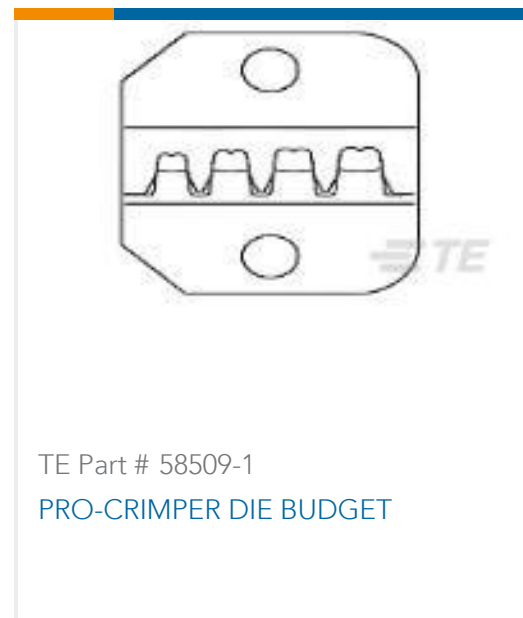

## Also in the Series | SOLISTRAND Budget

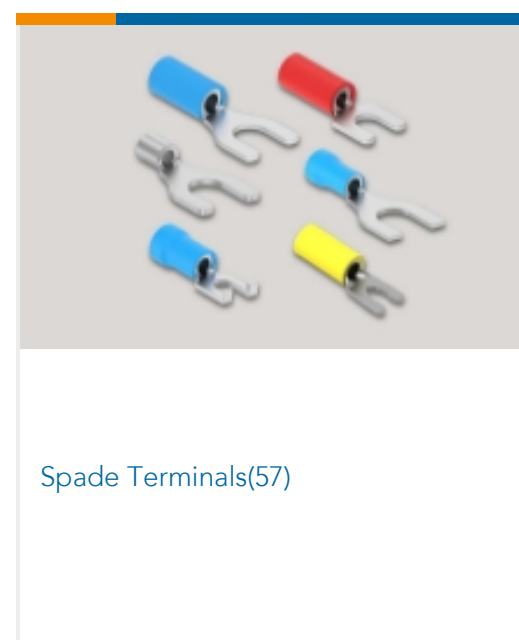
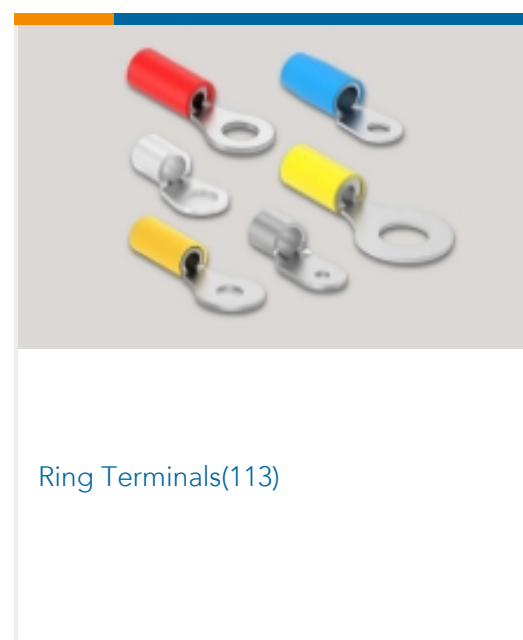
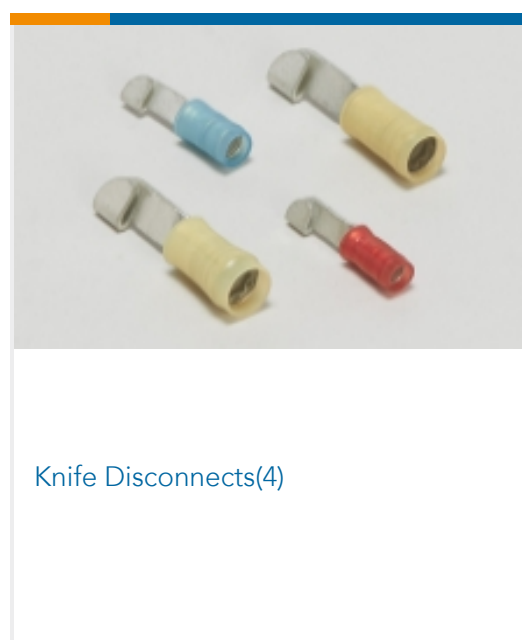

## Customers Also Bought

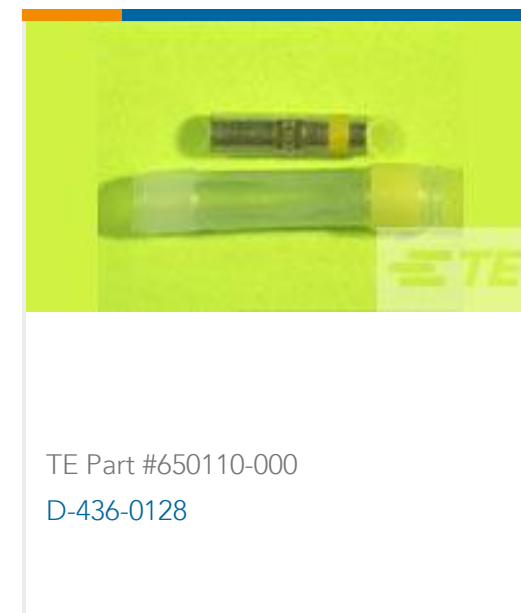
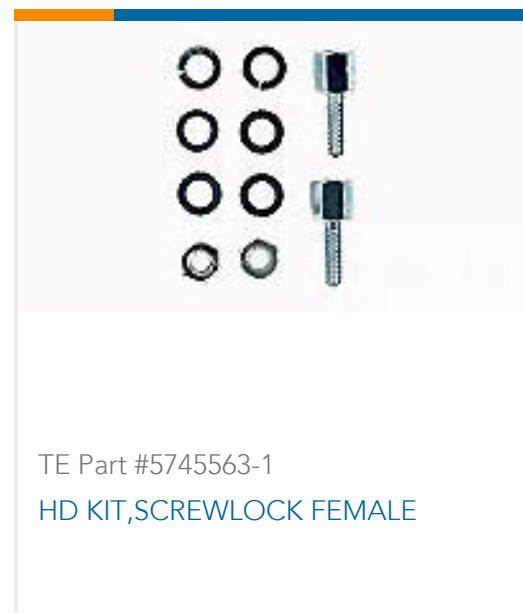

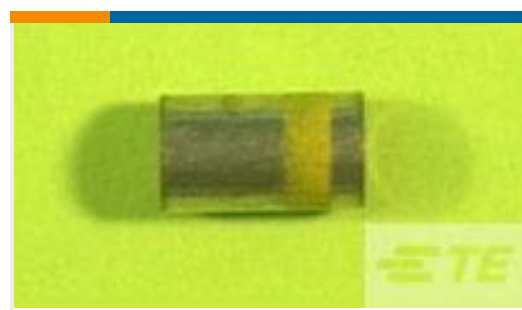

TE Part #680104-000  
D-609-03



TE Part #1-1337607-0  
SMC Str Plg PS 50Ohm Gold Pltd  
RG174A/U,



TE Part #2399607-5  
2POS,HVP1400,ASSY,180DEG,COD J  
/K



TE Part #60295-1  
FASTIN FASTON 250 REC 22-18 AWG  
BR



TE Part #2-1768020-1  
ESSW70-052

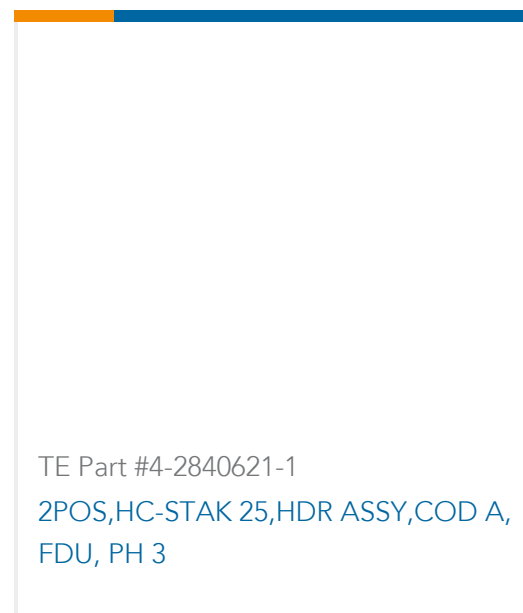

TE Part #4-2840621-1  
2POS,HC-STAK 25,HDR ASSY,COD A,  
FDU, PH 3

## Documents

### Product Drawings

[BUDG R 22-16 COMM 22-18 MIL 10](#)

English

### CAD Files

[3D PDF](#)

3D

Customer View Model

[ENG\\_CVM\\_CVM\\_30693\\_BN.2d\\_dxf.zip](#)

English

Customer View Model

[ENG\\_CVM\\_CVM\\_30693\\_BN.3d\\_igs.zip](#)

English

Customer View Model

[ENG\\_CVM\\_CVM\\_30693\\_BN.3d\\_stp.zip](#)

English

By downloading the CAD file I accept and agree to the [Terms and Conditions](#) of use.

### Product Environmental Compliance

[TE Material Declaration](#)

English

### Instruction Sheets

[Instruction Sheet \(U.S.\)](#)

English

### Agency Approvals

[UL Report](#)

30693

Closed Ring Tongue Terminal, 22 AWG, #10 Stud Size, 5 mm [.197 in] Stud Diameter,  
Closed Barrel, Straight, Tin, Uninsulated, SOLISTRAND Budget



English