

3-644662-4 ✓ ACTIVE



MTA 156

TE Internal #: 3-644662-4

Rectangular Power Connectors, Connector Assembly, Receptacle, Wire-to-Board, 4 Position, 3.96 mm [.156 in] Centerline, Wire & Cable, UL 94V-2, MTA 156

[View on TE.com >](#)

Connectors > Power Connectors > Rectangular Power > Rectangular Power Connectors

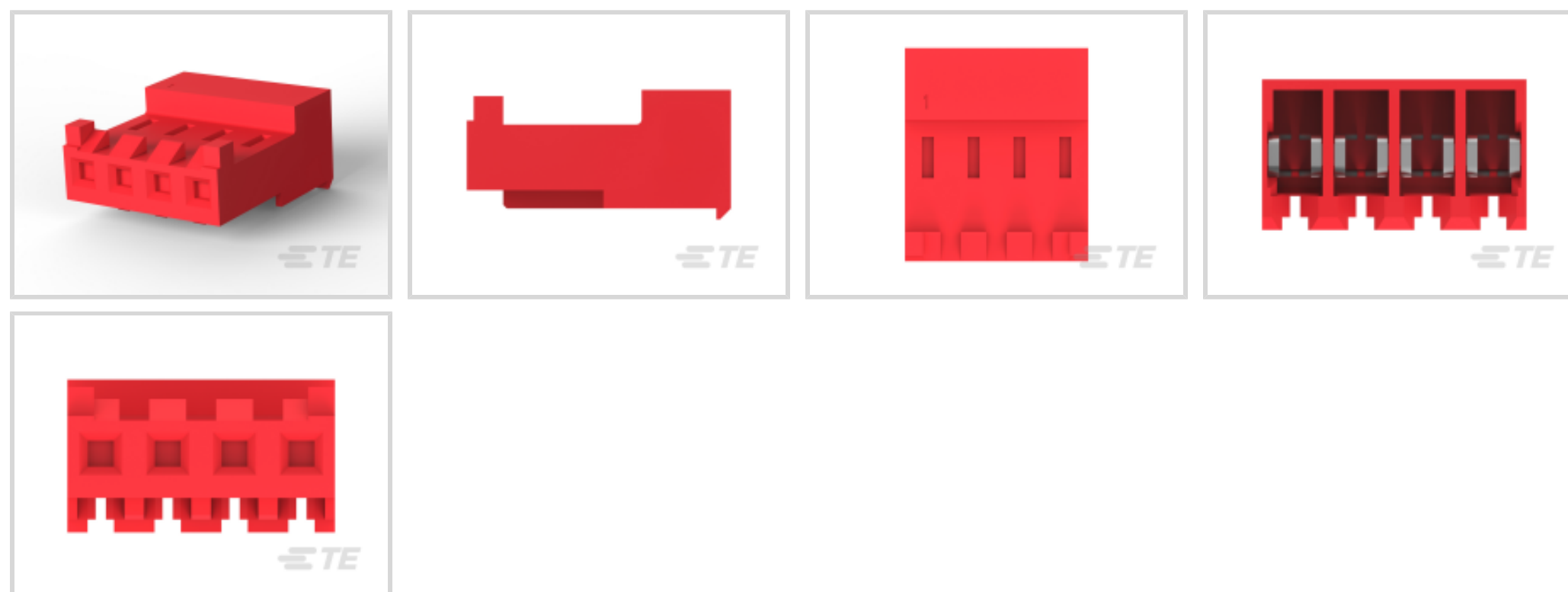

Rectangular Power Connector Type: **Connector Assembly**

Connector & Housing Type: **Receptacle**

Connector System: **Wire-to-Board**

Number of Positions: **4**

Centerline (Pitch): **3.96 mm [.156 in]**

Features

Product Type Features

Compatible With Discrete Wire Type	Stranded
Rectangular Power Connector Type	Connector Assembly
Connector & Housing Type	Receptacle
Connector System	Wire-to-Board
Sealable	No
Connector & Contact Terminates To	Wire & Cable

Configuration Features

Number of Positions	4
Number of Power Positions	4
Number of Signal Positions	0
Number of Rows	1

Electrical Characteristics

Operating Voltage	600 VAC
-------------------	---------

Body Features



Cable Exit Angle	90°
Connector Profile	Standard

Contact Features

Contact Layout	Inline
Contact Underplating Material Thickness	1.27 – 1.77 μm[1.27 – 1.77 μin]
Wire Contact Termination Area Plating Thickness	.76 μm[29.92 μin]
Contact Mating Area Plating Material	Gold, Gold Flash over Palladium Nickel
Contact Underplating Material	Nickel
Contact Base Material	Copper Alloy
Contact Current Rating (Max)	7 A
Contact Retention Within Housing	With
Contact Type	Receptacle
Wire Contact Termination Area Plating Material	Tin
Contact Mating Area Plating Material Thickness	.76 μm[30 μin]

Termination Features

Termination Method to Wire & Cable	Insulation Displacement (IDC)
------------------------------------	-------------------------------

Mechanical Attachment

Strain Relief	With
Mating Alignment Type	Polarizing Tab
Mating Retention	With
Mating Alignment	With
Contact Retention Type Within Housing	Locking Lance
PCB Mount Alignment	Without
Panel Mount Feature	Without
PCB Mount Retention	Without
Mating Retention Type	Locking Ramp
Connector Mounting Type	Cable Mount (Free-Hanging)

Housing Features

Wire & Cable IDC Installation Type	Closed End
Centerline (Pitch)	3.96 mm[.156 in]
Housing Color	Red
Housing Material	Nylon



Dimensions

Connector Height	9.02 mm [.355 in]
Product Length	15.85 mm [.624 in]
Compatible Insulation Diameter Range	2.41 mm [.095 in]
Wire Size	.3 – .4 mm ²

Usage Conditions

Operating Temperature Range	-55 – 105 °C [-67 – 221 °F]
-----------------------------	-----------------------------

Operation/Application

Circuit Application	Power & Signal
---------------------	----------------

Industry Standards

CSA Rating	Certified, LR 7189
UL Rating	Recognized
Agency/Standard	CSA, UL
Approved Standards	UL E28476
UL Flammability Rating	UL 94V-2
Glow Wire Rating	Standard Part - Not Glow Wire

Packaging Features

Packaging Quantity	250
Packaging Method	Bag

Product Compliance

[For compliance documentation, visit the product page on TE.com>](#)

EU RoHS Directive 2011/65/EU	Compliant
EU ELV Directive 2000/53/EC	Compliant
China RoHS 2 Directive MIIT Order No 32, 2016	No Restricted Materials Above Threshold
EU REACH Regulation (EC) No. 1907/2006	Current ECHA Candidate List: JUNE 2023 (235) Candidate List Declared Against: JUNE 2023 (235) Does not contain REACH SVHC
Halogen Content	BFR/CFR/PVC Free, but Br/Cl >900 ppm in other sources.
Solder Process Capability	Not applicable for solder process capability

Product Compliance Disclaimer

This information is provided based on reasonable inquiry of our suppliers and represents our current actual knowledge based on the information they provided. This information is subject to change. The part numbers that TE has identified as EU RoHS compliant have a maximum concentration of 0.1% by weight in homogenous materials for lead, hexavalent chromium, mercury, PBB, PBDE, DBP, BBP, DEHP, DIBP, and 0.01% for cadmium, or qualify for an exemption to these limits as defined in the Annexes of Directive 2011/65/EU (RoHS2). Finished electrical and electronic equipment products will be CE marked as required by Directive 2011/65/EU. Components may not be CE marked. Additionally, the part numbers that TE has identified as EU ELV compliant have a maximum concentration of 0.1% by weight in homogenous materials for lead, hexavalent chromium, and mercury, and 0.01% for cadmium, or qualify for an exemption to these limits as defined in the Annexes of Directive 2000/53/EC (ELV). Regarding the REACH Regulation, the information TE provides on SVHC in articles for this part number is based on the latest European Chemicals Agency (ECHA) 'Guidance on requirements for substances in articles' posted at this URL: <https://echa.europa.eu/guidance-documents/guidance-on-reach>

Compatible Parts



TE Part # 58074-1
MTA 50/100/156 MANUAL TOOL FRAME



TE Part # 3-641208-4
04P MTA156 HDR ASSY FL ST 30AU



TE Part # 3-641209-4
04P MTA156 HDR ASSY FL ST LF



TE Part # 640551-4
04P MTA156 COVER



TE Part # 640643-4
04P MTA156 COVER F/T



TE Part # 3-641210-4
04P MTA156 HDR FLRA FB 30AU LF



TE Part # 643071-4
04P MTA156 FD-THRU COVER



TE Part # 643067-4
04P MTA156 CMOLDED COVER



TE Part # 58247-3
MTA 156 CRIMP HEAD PRODUCTION RBBN CABLE



TE Part # 643493-1
04P MTA156 HDR ASSY STR W/O#2



TE Part # 643493-4
04P MTA156 HDR ASSY STR W/O#3



TE Part # 3-641202-4
04P MTA156 HDR ASSY PL 30AU LF



TE Part # 3-644631-4
04P MTA156 HDR ASSY STR LF



TE Part # 3-644633-4
04P MTA156 HDR ASSY R/A LF



TE Part # 3-644759-4
04P MTA156 HDR ASSY STR LF



TE Part # 3-644760-4
04P MTA156 HDR ASSY FL ST LF



TE Part # 3-644761-4
04P MTA156 HDR ASSY R/A F/L LF



TE Part # 58040-1
MTA 156 ARBOR FIXTURE DISCRETE RBN CABLE



TE Part # 58247-2
MTA 156 CRIMP HEAD PRODUCTION DISCRETE



TE Part # 58576-1
MTA 156 PNEUMATIC TOOL FOR BOARD FIXTURE

Also in the Series | MTA 156

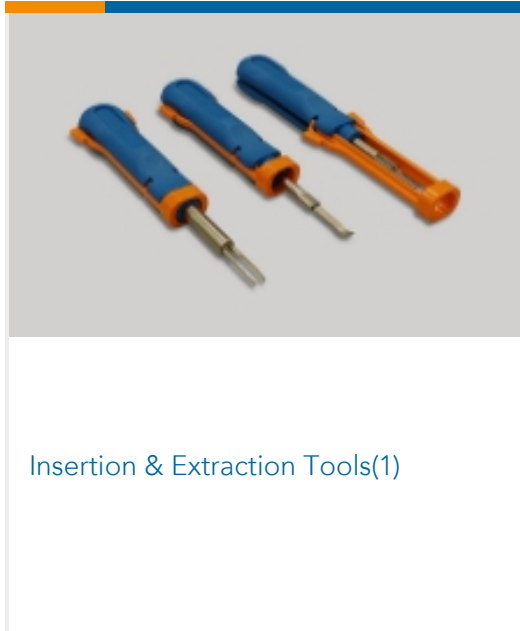

Insertion & Extraction Tools(1)



PCB Connector Covers(88)

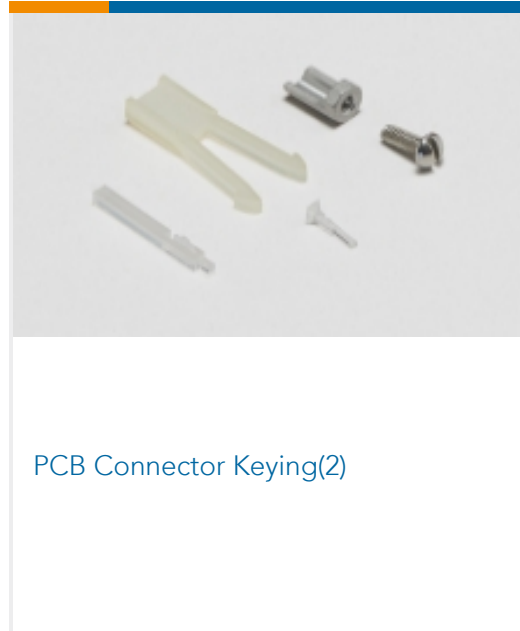

PCB Connector Keying(2)



PCB Connector Mounting(1)



PCB Headers & Receptacles(316)

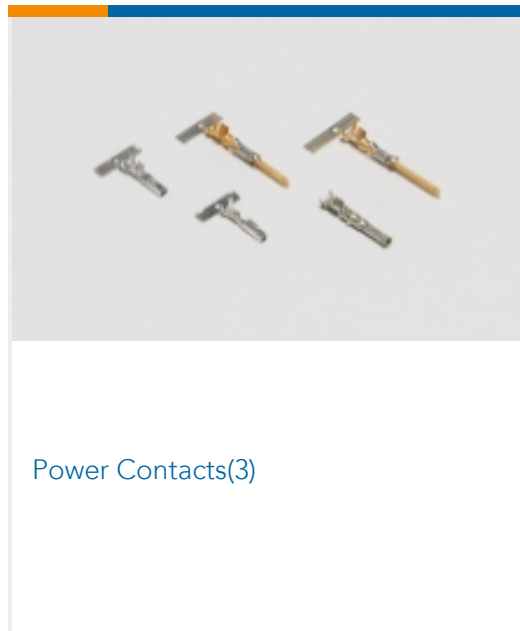

Power Contacts(3)



Rectangular Power Connectors(699)

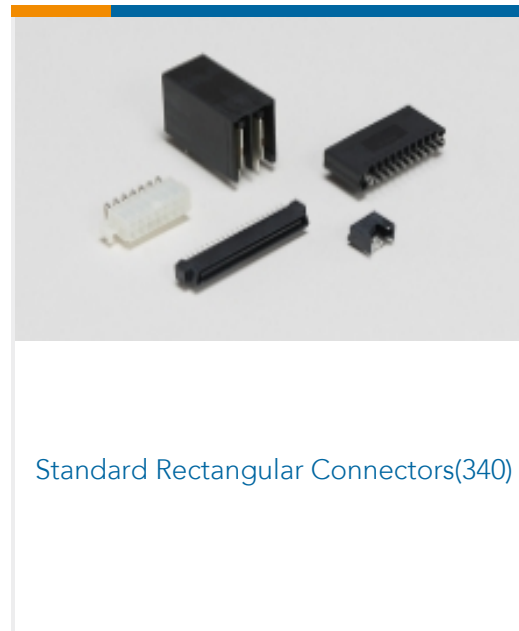

Standard Rectangular Connectors(340)

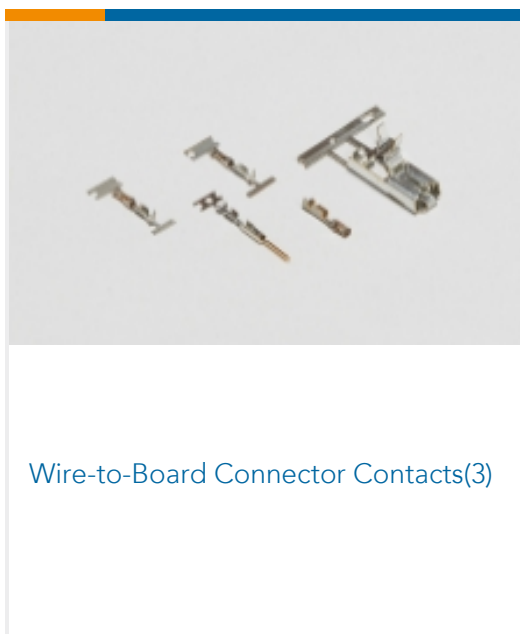

Wire-to-Board Connector Contacts(3)

Customers Also Bought



TE Part #173977-2
CT CONN MT REC ASSY 2P



TE Part #487378-3
004 HOUSING FFC RCPT 100CL SR



TE Part #3-644662-8
08P MTA156 CONN ASSY 22AWG LF



TE Part #350778-1
02P UMNL CAP HSG

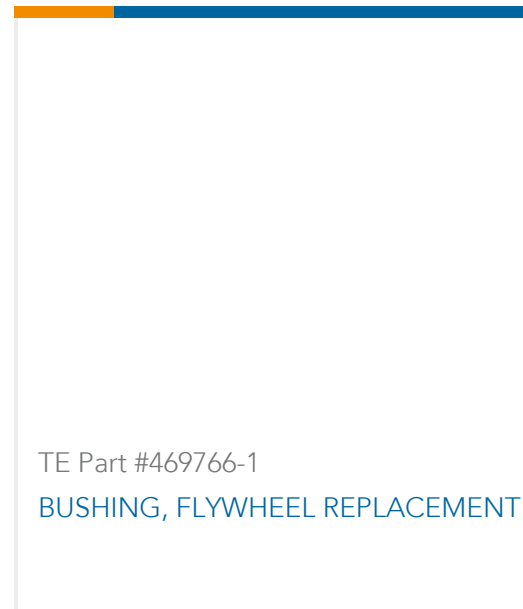
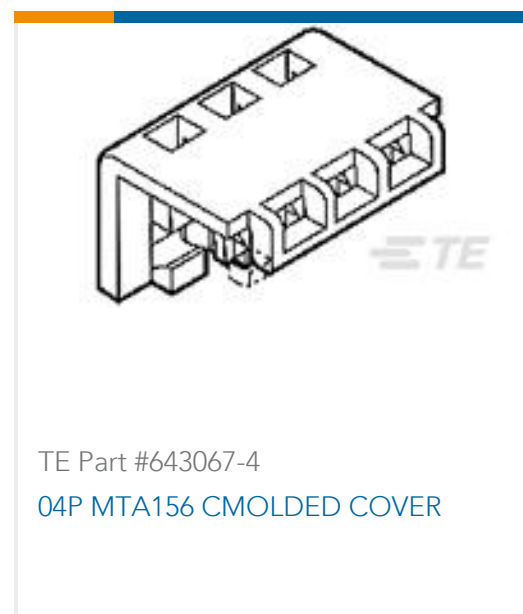

Documents

Product Drawings

04P MTA156 CONN ASSY 22AWG LF

English

CAD Files

3D PDF

3D

Customer View Model

[ENG_CVM_CVM_3-644662-4_J.2d_dxf.zip](#)

English

Customer View Model

[ENG_CVM_CVM_3-644662-4_J.3d_igs.zip](#)

English

Customer View Model

[ENG_CVM_CVM_3-644662-4_J.3d_stp.zip](#)

English

By downloading the CAD file I accept and agree to the [Terms and Conditions](#) of use.

Product Specifications

Application Specification

Japanese

Application Specification

English

[MTA 156 Ribbon Cable Connector Assemblies \(English And Spanish\)](#)

English

[MTA 156 Ribbon Cable Connector Assemblies \(English And Spanish\)](#)

Japanese



[Agency Approvals](#)

[Agency Approval Document](#)

English