

3-641220-4 ✓ ACTIVE



## MTA 156

TE Internal #: 3-641220-4

Rectangular Power Connectors, Connector Assembly, Receptacle, Wire-to-Board, 4 Position, 3.96 mm [.156 in] Centerline, Wire & Cable, UL 94V-2, MTA 156

[View on TE.com >](#)

Connectors > Power Connectors > Rectangular Power > Rectangular Power Connectors



Rectangular Power Connector Type: **Connector Assembly**

Connector & Housing Type: **Receptacle**

Connector System: **Wire-to-Board**

Number of Positions: **4**

Centerline (Pitch): **3.96 mm [.156 in]**

### Features

#### Product Type Features

Compatible With Discrete Wire Type	Stranded
Rectangular Power Connector Type	Connector Assembly
Connector & Housing Type	Receptacle
Connector System	Wire-to-Board
Sealable	No
Connector & Contact Terminates To	Wire & Cable

#### Configuration Features

Number of Positions	4
Number of Power Positions	4
Number of Rows	1

#### Electrical Characteristics

Operating Voltage	600 VAC
-------------------	---------

#### Body Features

Cable Exit Angle	90°
------------------	-----



Connector Profile	Standard
<b>Contact Features</b>	
Contact Layout	Inline
Contact Underplating Material Thickness	1.27 – 1.77 $\mu\text{m}$ [1.27 – 1.77 $\mu\text{in}$ ]
Wire Contact Termination Area Plating Thickness	2.03 – 5.08 $\mu\text{m}$ [80 – 200 $\mu\text{in}$ ]
Contact Mating Area Plating Material	Gold, Gold Flash over Palladium Nickel
Contact Underplating Material	Nickel
Contact Base Material	Copper Alloy
Contact Current Rating (Max)	7 A
Contact Retention Within Housing	With
Contact Type	Receptacle
Wire Contact Termination Area Plating Material	Tin
Contact Mating Area Plating Material Thickness	.76 $\mu\text{m}$ [30 $\mu\text{in}$ ]
<b>Termination Features</b>	
Termination Method to Wire & Cable	Insulation Displacement (IDC)
<b>Mechanical Attachment</b>	
Strain Relief	With
Mating Retention	With
Mating Alignment	Without
Contact Retention Type Within Housing	Locking Lance
PCB Mount Alignment	Without
Panel Mount Feature	Without
PCB Mount Retention	Without
Mating Retention Type	Locking Ramp
Connector Mounting Type	Cable Mount (Free-Hanging)
<b>Housing Features</b>	
Wire & Cable IDC Installation Type	Closed End
Centerline (Pitch)	3.96 mm [.156 in]
Housing Color	White
Housing Material	Nylon
<b>Dimensions</b>	
Connector Height	9.02 mm [.355 in]



Product Length	15.85 mm[.624 in]
----------------	-------------------

Compatible Insulation Diameter Range	2.41 mm[.095 in]
--------------------------------------	------------------

Wire Size	.2 mm <sup>2</sup>
-----------	--------------------

### Usage Conditions

Operating Temperature Range	-55 – 105 °C[-67 – 221 °F]
-----------------------------	----------------------------

### Operation/Application

Circuit Application	Power
---------------------	-------

### Industry Standards

CSA Rating	Certified, LR 7189
------------	--------------------

UL Rating	Recognized
-----------	------------

Agency/Standard	CSA, UL
-----------------	---------

Approved Standards	UL E28476
--------------------	-----------

UL Flammability Rating	UL 94V-2
------------------------	----------

Glow Wire Rating	Standard Part - Not Glow Wire
------------------	-------------------------------

### Packaging Features

Packaging Quantity	250
--------------------	-----

Packaging Method	Bag
------------------	-----

### Product Compliance

[For compliance documentation, visit the product page on TE.com>](#)

EU RoHS Directive 2011/65/EU	Compliant
------------------------------	-----------

EU ELV Directive 2000/53/EC	Compliant
-----------------------------	-----------

China RoHS 2 Directive MIIT Order No 32, 2016	No Restricted Materials Above Threshold
---	---

EU REACH Regulation (EC) No. 1907/2006	Current ECHA Candidate List: JUNE 2023 (235) Candidate List Declared Against: JAN 2023 (233) Does not contain REACH SVHC
--	--

Halogen Content	Low Halogen - Br, Cl, F, I < 900 ppm per homogenous material. Also BFR/CFR/PVC Free
-----------------	---







Solder Process Capability	Not applicable for solder process capability
---------------------------	--

#### Product Compliance Disclaimer

This information is provided based on reasonable inquiry of our suppliers and represents our current actual knowledge based on the information they provided. This information is subject to change. The part numbers that TE has identified as

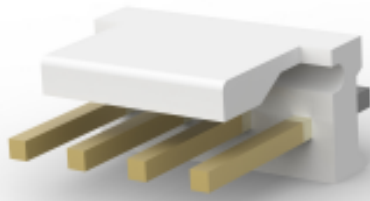
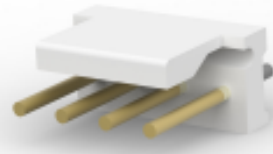
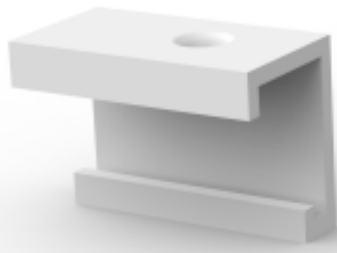
EU RoHS compliant have a maximum concentration of 0.1% by weight in homogenous materials for lead, hexavalent chromium, mercury, PBB, PBDE, DBP, BBP, DEHP, DIBP, and 0.01% for cadmium, or qualify for an exemption to these limits as defined in the Annexes of Directive 2011/65/EU (RoHS2). Finished electrical and electronic equipment products will be CE marked as required by Directive 2011/65/EU. Components may not be CE marked. Additionally, the part numbers that TE has identified as EU ELV compliant have a maximum concentration of 0.1% by weight in homogenous materials for lead, hexavalent chromium, and mercury, and 0.01% for cadmium, or qualify for an exemption to these limits as defined in the Annexes of Directive 2000/53/EC (ELV). Regarding the REACH Regulation, the information TE provides on SVHC in articles for this part number is based on the latest European Chemicals Agency (ECHA) 'Guidance on requirements for substances in articles' posted at this URL: <https://echa.europa.eu/guidance-documents/guidance-on-reach>

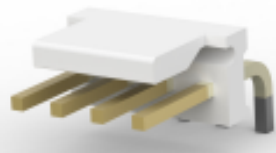
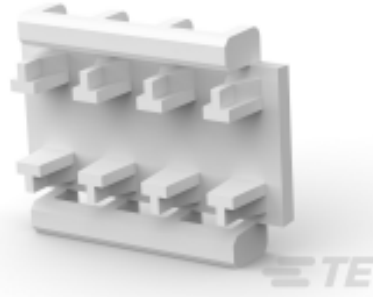
## Compatible Parts

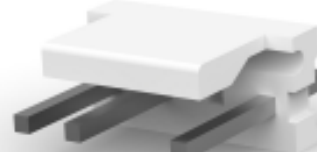
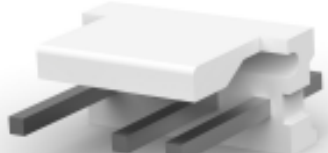
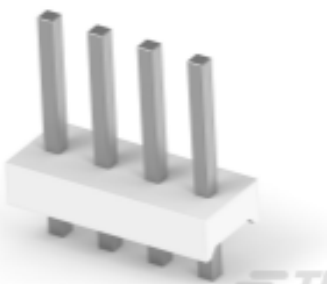
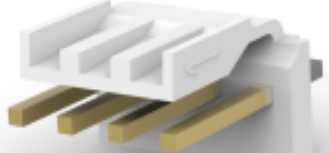
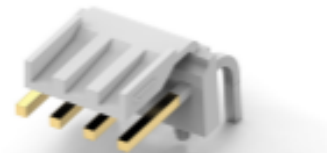
 <p>TE Part # 58074-1 MTA 50/100/156 MANUAL TOOL FRAME</p>	 <p>TE Part # 59804-1 MAINTENANCE TOOL</p>	 <p>TE Part # 643067-4 04P MTA156 CMOLDED COVER</p>	 <p>TE Part # 3-641208-4 04P MTA156 HDR ASSY FL ST 30AU</p>
 <p>TE Part # 3-641209-4 04P MTA156 HDR ASSY FL ST LF</p>	 <p>TE Part # 640551-4 04P MTA156 COVER</p>	 <p>TE Part # 640643-4 04P MTA156 COVER F/T</p>	 <p>TE Part # 3-641210-4 04P MTA156 HDR FLRA FB 30AU LF</p>
 <p>TE Part # 643071-4 04P MTA156 FD-THRU COVER</p>	 <p>TE Part # 58247-1 MTA 156 CRIMP HEAD REPAIR DISCRETE</p>	 <p>TE Part # 58247-3 MTA 156 CRIMP HEAD PRODUCTION RBBN CABLE</p>	 <p>TE Part # 643493-1 04P MTA156 HDR ASSY STR W/O#2</p>
 <p>TE Part # 643493-4 04P MTA156 HDR ASSY STR W/O#3</p>	 <p>TE Part # 3-641202-4 04P MTA156 HDR ASSY PL 30AU LF</p>	 <p>TE Part # 3-644631-4 04P MTA156 HDR ASSY STR LF</p>	 <p>TE Part # 3-644633-4 04P MTA156 HDR ASSY R/A LF</p>





TE Part # 3-644759-4  
04P MTA156 HDR ASSY STR LF



TE Part # 3-644760-4  
04P MTA156 HDR ASSY FL ST LF



TE Part # 3-644761-4  
04P MTA156 HDR ASSY R/A F/L LF



TE Part # 3-644807-4  
04P MTA156 PSTD CONN 18AWG LF

Also in the Series | **MTA 156**



Connector Caps & Covers(88)

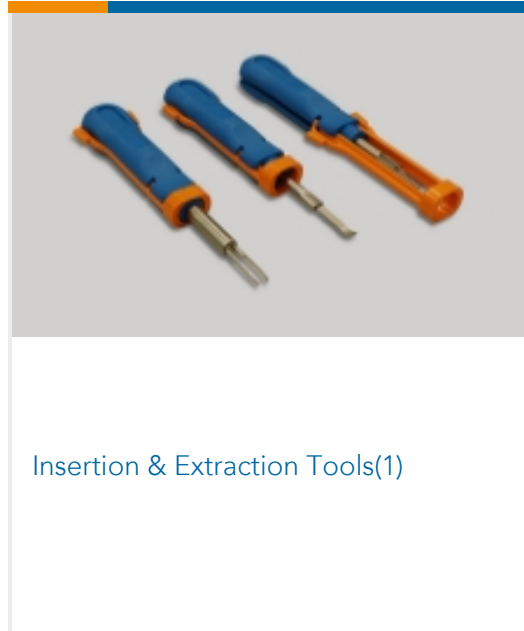

Insertion & Extraction Tools(1)

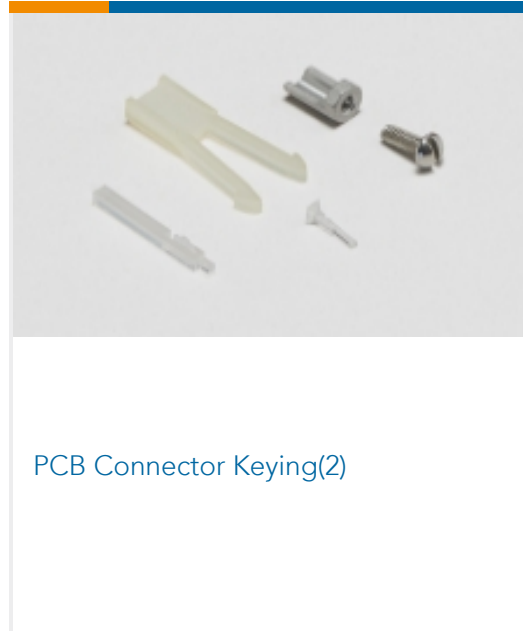

PCB Connector Keying(2)

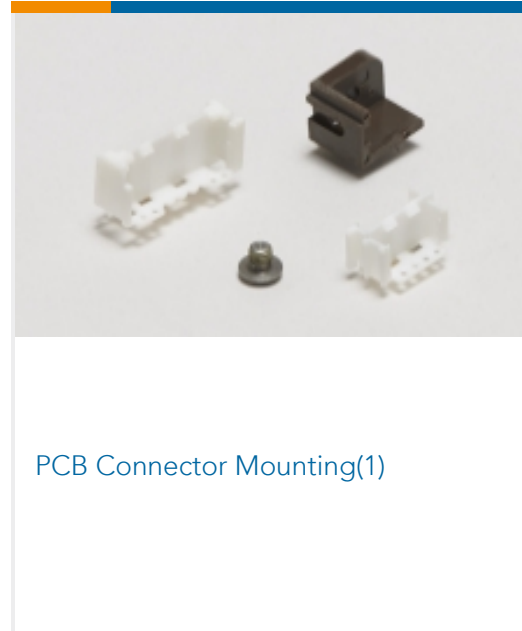

PCB Connector Mounting(1)



PCB Headers & Receptacles(314)

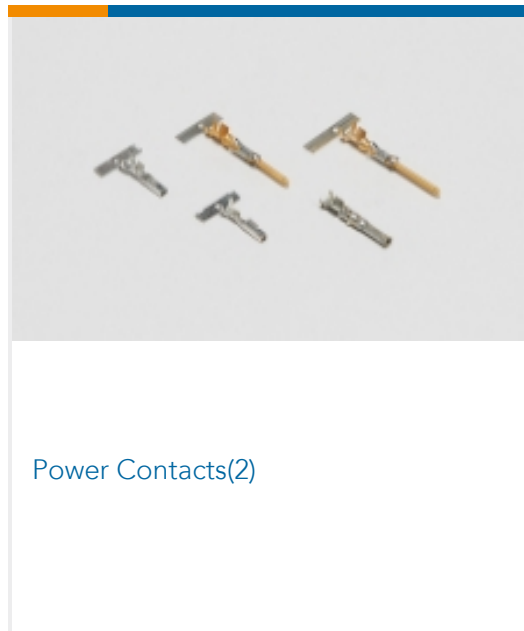

Power Contacts(2)



Rectangular Power Connectors(698)

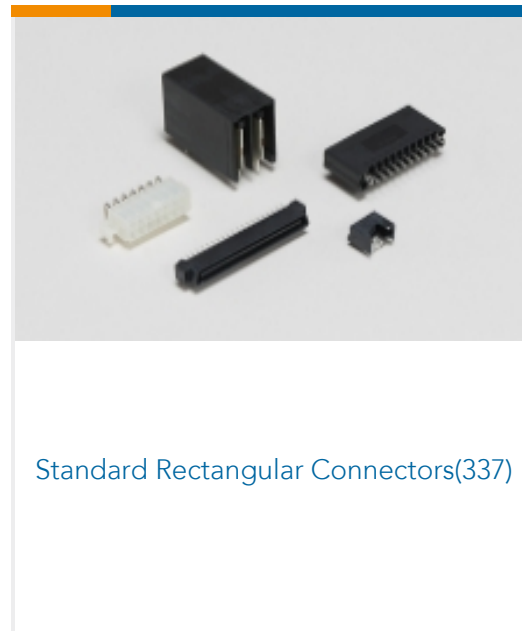

Standard Rectangular Connectors(337)

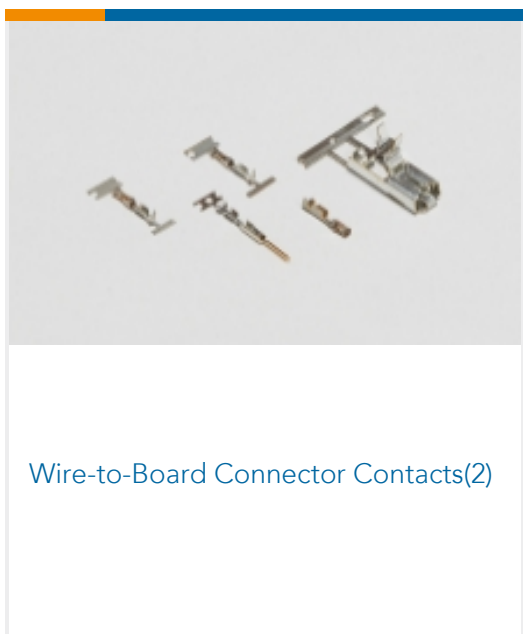

Wire-to-Board Connector Contacts(2)

Customers Also Bought



TE Part #206433-1  
CPC RECPT ASSEMBLY SIZE 11-8



TE Part #206425-1  
17-3 RECPT. REV SEX



TE Part #2-6609106-1  
PS0SSSHXA=C1109

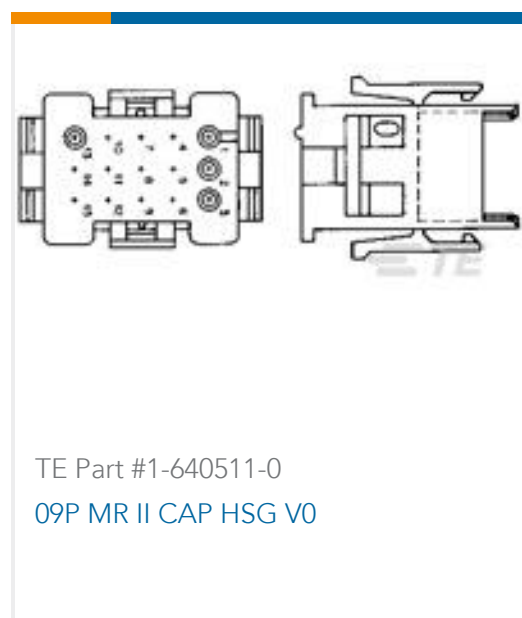

TE Part #1-640511-0  
09P MR II CAP HSG V0

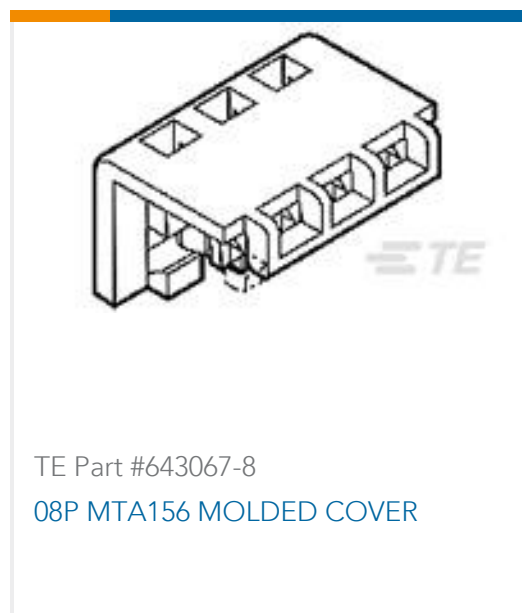
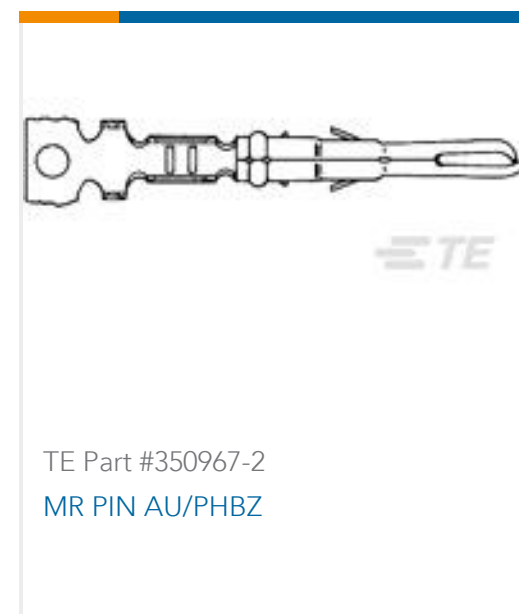
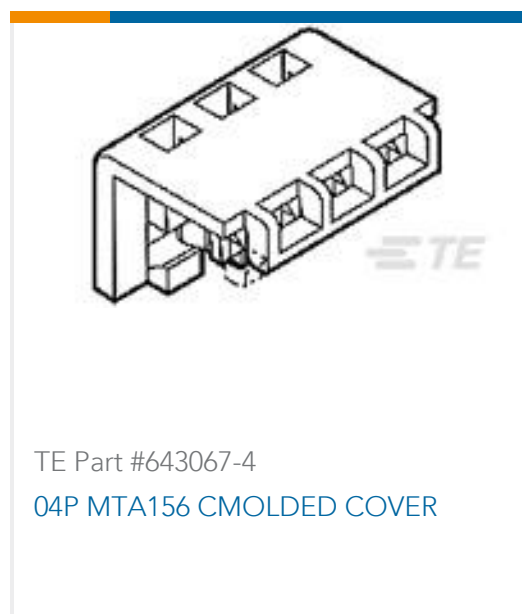

## Documents

### Product Drawings

#### 04P MTA156 CONN ASSY 24AWG LF

English

### CAD Files

#### 3D PDF

3D

#### Customer View Model

[ENG\\_CVM\\_CVM\\_3-641220-4\\_N.2d\\_dxf.zip](#)

English

#### Customer View Model

[ENG\\_CVM\\_CVM\\_3-641220-4\\_N.3d\\_igs.zip](#)

English

#### Customer View Model

[ENG\\_CVM\\_CVM\\_3-641220-4\\_N.3d\\_stp.zip](#)

English

By downloading the CAD file I accept and agree to the [Terms and Conditions](#) of use.

### Product Specifications

#### Application Specification

Japanese

#### Application Specification

English

#### MTA 156 Ribbon Cable Connector Assemblies (English And Spanish)

English

#### MTA 156 Ribbon Cable Connector Assemblies (English And Spanish)

Japanese



---

**Product Environmental Compliance**

[TE Material Declaration](#)

English

---

**Agency Approvals**

[Agency Approval Document](#)

English