



MTA 100

TE Internal #: 3-641192-6

Standard Rectangular Connectors, Connector Assembly, Receptacle, Mating Retention, Insulation Displacement (IDC), Wire-to-Board, MTA 100

[View on TE.com >](#)

Connectors > Rectangular Connectors > Standard Rectangular Connectors > Nylon Gold Plated Receptacle: 2.54 mm, no Mating Alignment

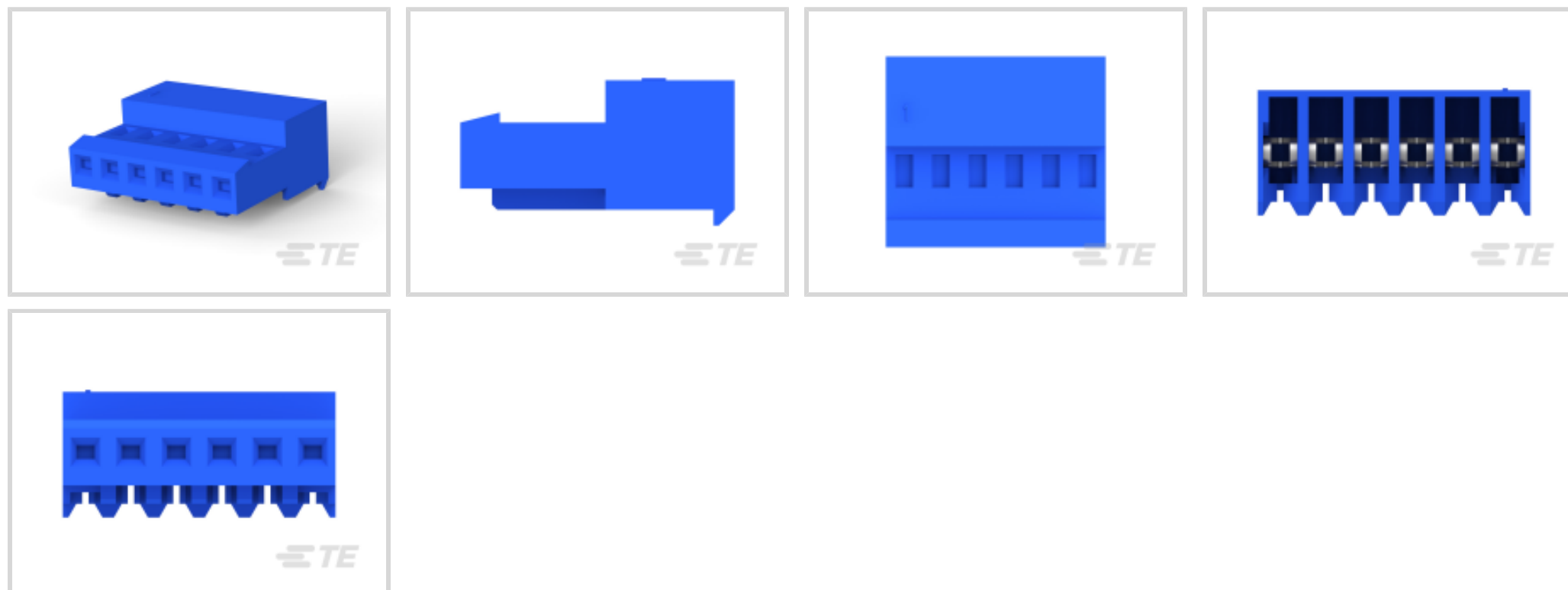

Connector Product Type: **Connector Assembly**

Connector & Housing Type: **Receptacle**

Mating Alignment: **Without**

Mating Retention: **With**

Mating Retention Type: **Locking Ramp**

[All Nylon Gold Plated Receptacle: 2.54 mm, no Mating Alignment \(89\)](#)

## Features

### Product Type Features

|                                    |                    |
|------------------------------------|--------------------|
| Compatible With Discrete Wire Type | Stranded           |
| Connector Product Type             | Connector Assembly |
| Connector & Housing Type           | Receptacle         |
| Connector System                   | Wire-to-Board      |
| Insertion Force Type               | Normal             |
| Sealable                           | No                 |
| Connector & Contact Terminates To  | Wire & Cable       |

### Configuration Features

|                     |     |
|---------------------|-----|
| Number of Cavities  | 6   |
| Contacts Preloaded  | Yes |
| Number of Positions | 6   |
| Number of Rows      | 1   |



### Electrical Characteristics

|                   |         |
|-------------------|---------|
| Operating Voltage | 250 VAC |
|-------------------|---------|

### Contact Features

|  |  |
|--|--|
| Contact Type                                   | Receptacle                             |
| Wire Contact Termination Area Plating Material | Tin                                    |
| Contact Underplating Material                  | Nickel                                 |
| Contact Mating Area Plating Material           | Gold, Gold Flash over Palladium Nickel |
| Contact Retention Within Housing               | With                                   |
| Contact Current Rating (Max)                   | 5 A                                    |

### Termination Features

|                                    |                               |
|------------------------------------|-------------------------------|
| Termination Method to Wire & Cable | Insulation Displacement (IDC) |
|------------------------------------|-------------------------------|

### Mechanical Attachment

|                         |                            |
|-------------------------|----------------------------|
| Mating Alignment        | Without                    |
| Mating Retention        | With                       |
| Mating Retention Type   | Locking Ramp               |
| Connector Mounting Type | Cable Mount (Free-Hanging) |

### Housing Features

|                    |                |
|--------------------|----------------|
| Housing Material   | Nylon          |
| Housing Color      | Blue           |
| Centerline (Pitch) | 2.54 mm[.1 in] |

### Dimensions

|                  |                           |
|------------------|---------------------------|
| Connector Height | 13.21 mm[.52 in]          |
| Product Width    | 7.75 mm[.305 in]          |
| Product Length   | 15.42 mm[.6 in]           |
| Wire Size        | .12 – .15 mm <sup>2</sup> |

### Usage Conditions

|                             |                            |
|-----------------------------|----------------------------|
| Operating Temperature Range | -55 – 105 °C[-67 – 221 °F] |
|-----------------------------|----------------------------|

### Operation/Application

|                     |        |
|---------------------|--------|
| Shielded            | No     |
| Circuit Application | Signal |

### Industry Standards

|            |         |
|------------|---------|
| CSA Rating | LR 7189 |
|------------|---------|



|                        |            |
|------------------------|------------|
| UL Rating              | Recognized |
| Agency/Standard        | CSA, UL    |
| Approved Standards     | UL E28476  |
| UL Flammability Rating | UL 94V-2   |

### Packaging Features

|                    |         |
|--------------------|---------|
| Packaging Quantity | 500     |
| Packaging Method   | Bag/Box |

### Product Compliance

[For compliance documentation, visit the product page on TE.com>](#)

|   |   |
|---|---|
| EU RoHS Directive 2011/65/EU                  | Compliant   |
| EU ELV Directive 2000/53/EC                   | Compliant   |
| China RoHS 2 Directive MIIT Order No 32, 2016 | No Restricted Materials Above Threshold   |
| EU REACH Regulation (EC) No. 1907/2006        | Current ECHA Candidate List: JUNE 2023 (235)<br>Candidate List Declared Against: JUNE 2023 (235)<br>Does not contain REACH SVHC |
| Halogen Content                               | Low Halogen - Br, Cl, F, I < 900 ppm per homogenous material. Also BFR/CFR/PVC Free   |
| Solder Process Capability                     | Not applicable for solder process capability  |

#### Product Compliance Disclaimer

This information is provided based on reasonable inquiry of our suppliers and represents our current actual knowledge based on the information they provided. This information is subject to change. The part numbers that TE has identified as EU RoHS compliant have a maximum concentration of 0.1% by weight in homogenous materials for lead, hexavalent chromium, mercury, PBB, PBDE, DBP, BBP, DEHP, DIBP, and 0.01% for cadmium, or qualify for an exemption to these limits as defined in the Annexes of Directive 2011/65/EU (RoHS2). Finished electrical and electronic equipment products will be CE marked as required by Directive 2011/65/EU. Components may not be CE marked. Additionally, the part numbers that TE has identified as EU ELV compliant have a maximum concentration of 0.1% by weight in homogenous materials for lead, hexavalent chromium, and mercury, and 0.01% for cadmium, or qualify for an exemption to these limits as defined in the Annexes of Directive 2000/53/EC (ELV). Regarding the REACH Regulation, the information TE provides on SVHC in articles for this part number is based on the latest European Chemicals Agency (ECHA) 'Guidance on requirements for substances in articles' posted at this URL: <https://echa.europa.eu/guidance-documents/guidance-on-reach>

### Compatible Parts



TE Part # CAT-104MTA-PLSCC  
Polyester PCB Connector Covers: 2.54 mm, MTA 100



TE Part # CAT-104MTA-PVUNH  
PCB Header: Polyester, Vertical, Unshrouded, No Mating Alignment



TE Part # CAT-104MTA-NYLCC  
Nylon PCB Connector Covers: 2.54 mm, MTA 100



TE Part # 3-647167-6  
06P MTA100 HDR ASSY SM 15AU LF



TE Part # 58074-1  
MTA 50/100/156 MANUAL TOOL FRAME



TE Part # CAT-104MTA-PRUSH  
PCB Header: Polyester, Right Angle, Unshrouded



TE Part # 3-647078-6  
06P MTA100 HDR HT FL 15AU LF



TE Part # 58246-3  
MTA 100 CRIMP HEAD PRODUCTION RBBN CABLE



TE Part # 58579-1  
MTA 100 MANUAL TOOL ASSEMBLY DISCRETE



TE Part # 58039-1  
MTA 100 ARBOR FIXTURE DISCRETE RBN CABLE



TE Part # 58246-2  
MTA 100 CRIMP HEAD PRODUCTION DISCRETE

Also in the Series | **MTA 100**



Connector Caps & Covers(69)



Insertion & Extraction Tools(2)



PCB Connector Keying(1)



PCB Headers & Receptacles(440)



Standard Rectangular Connectors(495)



Wire-to-Board Connector Assemblies & Housings(1)

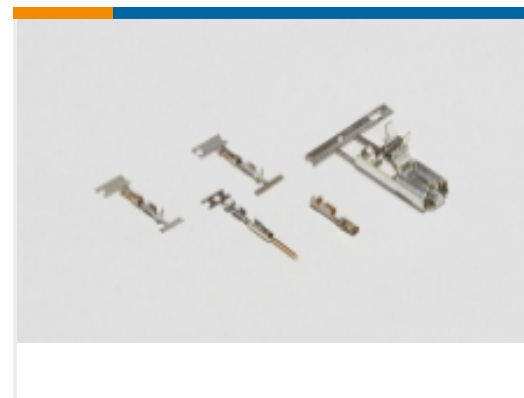

Wire-to-Board Connector Contacts(8)

Customers Also Bought

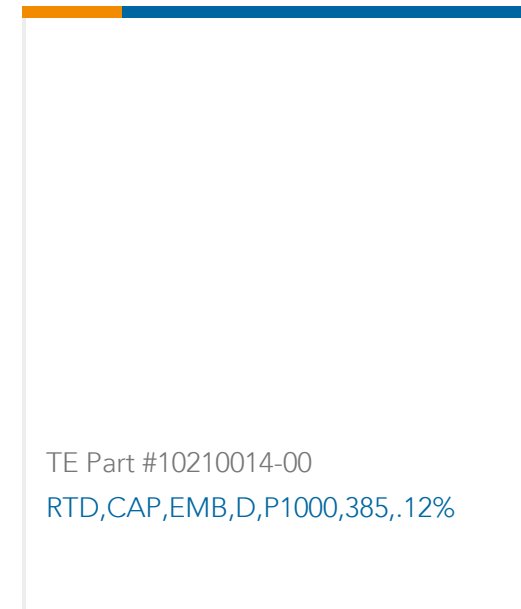
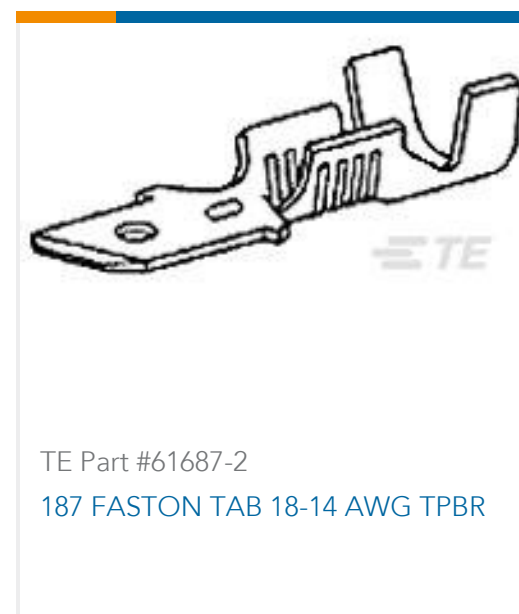

## Documents

### Product Drawings

#### 06P MTA100 CONN ASSY BLU LF

English

### CAD Files

#### 3D PDF

3D

#### Customer View Model

[ENG\\_CVM\\_CVM\\_3-641192-6\\_AA.2d\\_dxf.zip](#)

English

#### Customer View Model

[ENG\\_CVM\\_CVM\\_3-641192-6\\_AA.3d\\_igs.zip](#)

English

#### Customer View Model

[ENG\\_CVM\\_CVM\\_3-641192-6\\_AA.3d\\_stp.zip](#)

English

By downloading the CAD file I accept and agree to the [Terms and Conditions](#) of use.

### Product Specifications

#### Application Specification

English

### Product Environmental Compliance

#### Product Compliance Document

English

#### Product Compliance Document

English



[Agency Approvals](#)

[CSA Certificate](#)

English