



MTA 156

TE Internal #: 3-640601-9

Standard Rectangular Connectors, Connector Assembly, Receptacle, Mating Retention, Insulation Displacement (IDC), Wire-to-Board, Tin, Normal, MTA 156

[View on TE.com >](#)

Connectors > Rectangular Connectors > Standard Rectangular Connectors

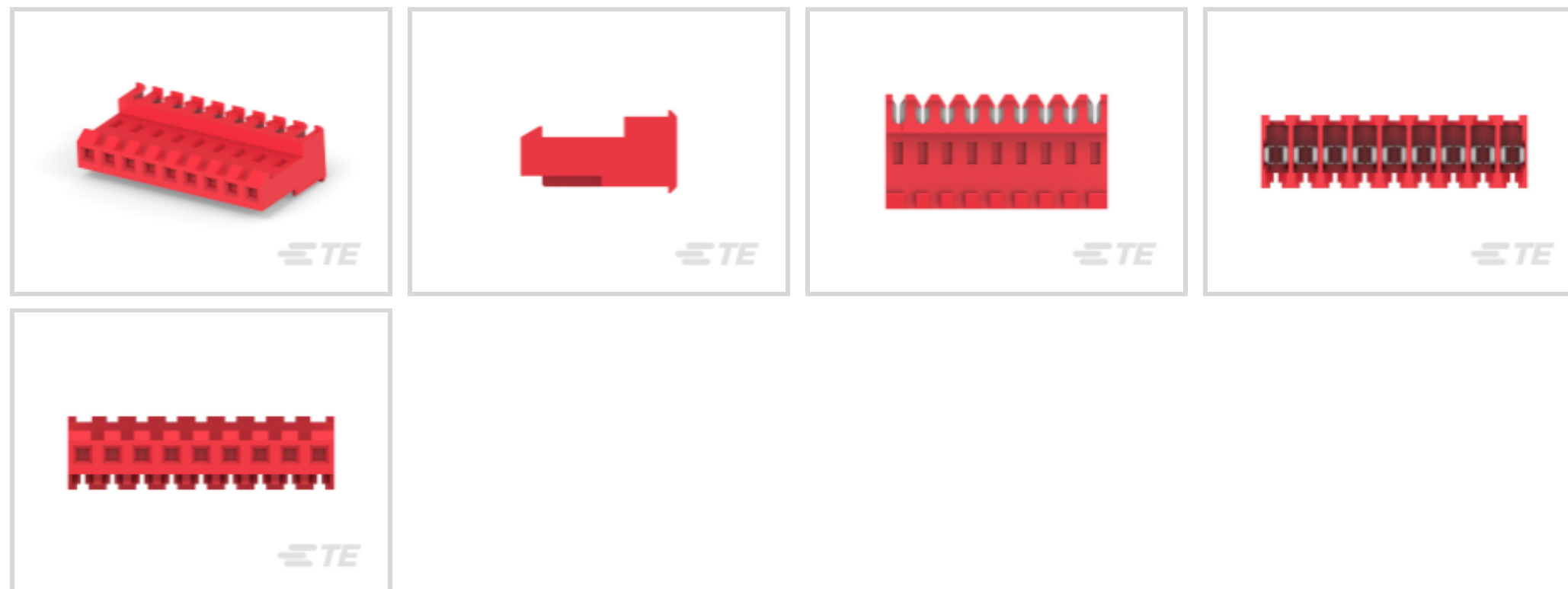

Connector Product Type: **Connector Assembly**

Connector & Housing Type: **Receptacle**

Mating Alignment: **Without**

Mating Retention: **With**

Mating Retention Type: **Locking Ramp**

**Features**

**Product Type Features**

Compatible With Discrete Wire Type	Stranded
Connector Product Type	Connector Assembly
Connector & Housing Type	Receptacle
Connector System	Wire-to-Board
Insertion Force Type	Normal
Sealable	No
Connector & Contact Terminates To	Wire & Cable

**Configuration Features**

Number of Cavities	9
Contacts Preloaded	Yes
Number of Positions	9
Number of Rows	1

**Electrical Characteristics**

Operating Voltage	600 VAC
-------------------	---------



### Contact Features

Contact Type	Receptacle
Wire Contact Termination Area Plating Material	Tin
Contact Underplating Material	Nickel
Contact Mating Area Plating Material	Tin
Contact Retention Within Housing	With
Contact Current Rating (Max)	7 A

### Termination Features

Termination Method to Wire & Cable	Insulation Displacement (IDC)
------------------------------------	-------------------------------

### Mechanical Attachment

Contact Retention Type Within Housing	Locking Lance
Mating Alignment	Without
Mating Retention	With
Mating Retention Type	Locking Ramp
Connector Mounting Type	Cable Mount (Free-Hanging)

### Housing Features

Housing Material	Nylon
Housing Color	Red
Centerline (Pitch)	3.96 mm[.156 in]

### Dimensions

Connector Height	18.42 mm[.725 in]
Product Width	9.78 mm[.385 in]
Product Length	35.66 mm[1.404 in]
Wire Size	.3 – .4 mm <sup>2</sup>

### Usage Conditions

Operating Temperature Range	-55 – 105 °C[-67 – 221 °F]
-----------------------------	----------------------------

### Operation/Application

Shielded	No
Circuit Application	Signal

### Industry Standards

CSA Rating	LR 7189
UL Rating	Recognized



Agency/Standard	CSA, UL
Approved Standards	UL E28476
UL Flammability Rating	UL 94V-2

### Packaging Features

Packaging Quantity	250
Packaging Method	Bag/Box

### Product Compliance

[For compliance documentation, visit the product page on TE.com>](#)

EU RoHS Directive 2011/65/EU	Compliant
EU ELV Directive 2000/53/EC	Compliant
China RoHS 2 Directive MIIT Order No 32, 2016	No Restricted Materials Above Threshold
EU REACH Regulation (EC) No. 1907/2006	Current ECHA Candidate List: JUNE 2023 (235) Candidate List Declared Against: JUNE 2023 (235) Does not contain REACH SVHC
Halogen Content	BFR/CFR/PVC Free, but Br/Cl >900 ppm in other sources.
Solder Process Capability	Not applicable for solder process capability

#### Product Compliance Disclaimer

This information is provided based on reasonable inquiry of our suppliers and represents our current actual knowledge based on the information they provided. This information is subject to change. The part numbers that TE has identified as EU RoHS compliant have a maximum concentration of 0.1% by weight in homogenous materials for lead, hexavalent chromium, mercury, PBB, PBDE, DBP, BBP, DEHP, DIBP, and 0.01% for cadmium, or qualify for an exemption to these limits as defined in the Annexes of Directive 2011/65/EU (RoHS2). Finished electrical and electronic equipment products will be CE marked as required by Directive 2011/65/EU. Components may not be CE marked. Additionally, the part numbers that TE has identified as EU ELV compliant have a maximum concentration of 0.1% by weight in homogenous materials for lead, hexavalent chromium, and mercury, and 0.01% for cadmium, or qualify for an exemption to these limits as defined in the Annexes of Directive 2000/53/EC (ELV). Regarding the REACH Regulation, the information TE provides on SVHC in articles for this part number is based on the latest European Chemicals Agency (ECHA) 'Guidance on requirements for substances in articles' posted at this URL: <https://echa.europa.eu/guidance-documents/guidance-on-reach>

### Compatible Parts



TE Part # 58074-1  
MTA 50/100/156 MANUAL TOOL FRAME



TE Part # 59804-1  
MAINTENANCE TOOL



TE Part # 58443-1  
MTA 156 CRIMP HEAD PRODUCTION FEED THRU



TE Part # 640388-9  
09P MTA156 HDR ASSY RN STR F/L FEED THRU



TE Part # 640643-9  
09P MTA156 COVER F/T



TE Part # 640445-9  
09P MTA156 HDR ASSY FL/STR SN



TE Part # 640383-9  
09P MTA156 HDR ASSY STR SQ SN



TE Part # 640551-9  
09P MTA156 COVER



TE Part # 643067-9  
09P MTA156 MOLDED COVER



TE Part # 643071-9  
09P MTA156 FD-THRU COVER



TE Part # 3-641438-9  
09P MTA156 PSTD CONN ASSY WHT



TE Part # 640385-9  
09P MTA156 HDR ASSY SQ R/A



TE Part # 640389-9  
09P MTA156 HDR ASSY SQ R/A F/L



TE Part # 640384-9  
09P MTA156 HDR ASSY STR RND SN



TE Part # 644752-9  
09P MTA156 HDR ASSY SQ STR F/L



TE Part # 3-644615-9  
09P MTA156 POL HDR ASSY LF



TE Part # 3-641435-9  
09P MTA156 CONN ASSY ORNG



TE Part # 2-647123-9  
09P MTA156 SHRD HDR ASSY SQ SN



TE Part # 641936-6  
09P MTA156 HDR ASSY F/L W/O#8



TE Part # 2-647125-9  
09P MTA156 SHRD HDR ASSY LF

Also in the Series | **MTA 156**





Connector Caps & Covers(88)

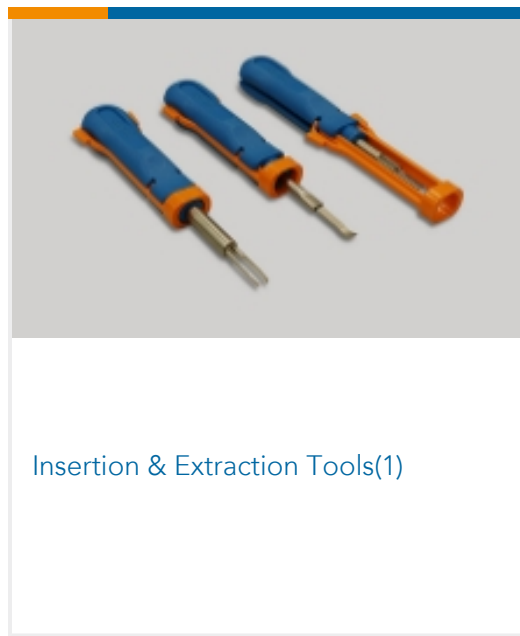

Insertion & Extraction Tools(1)

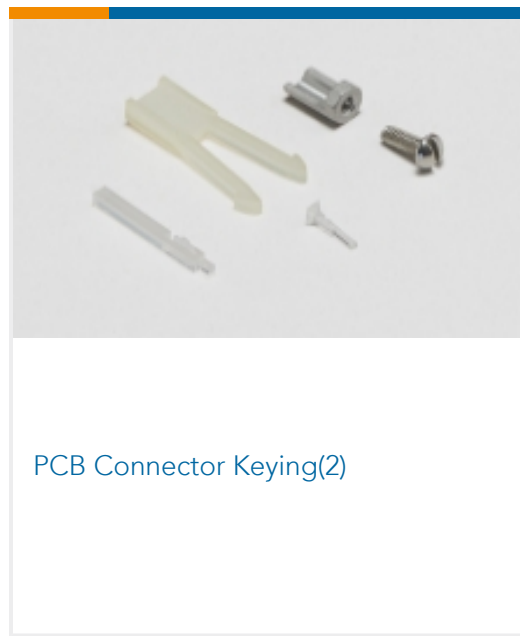

PCB Connector Keying(2)



PCB Connector Mounting(1)



PCB Headers & Receptacles(314)

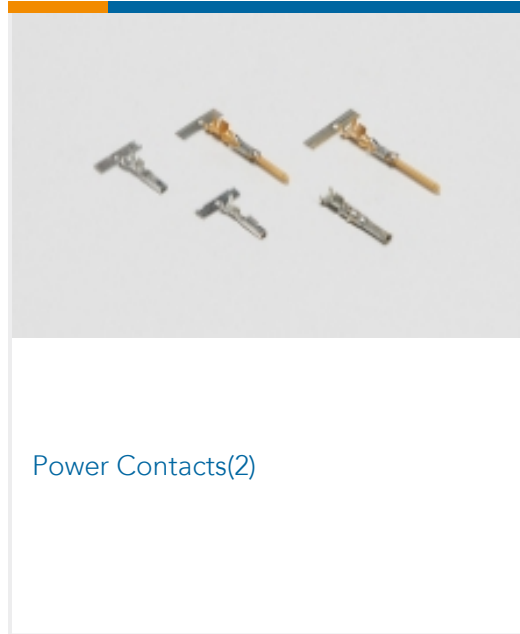

Power Contacts(2)



Rectangular Power Connectors(698)

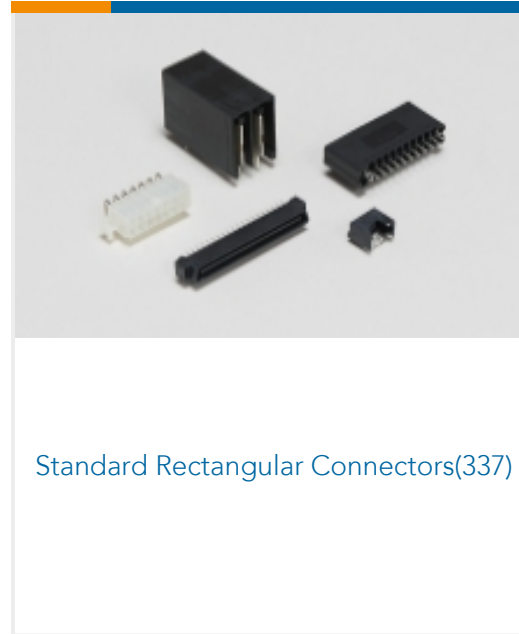

Standard Rectangular Connectors(337)

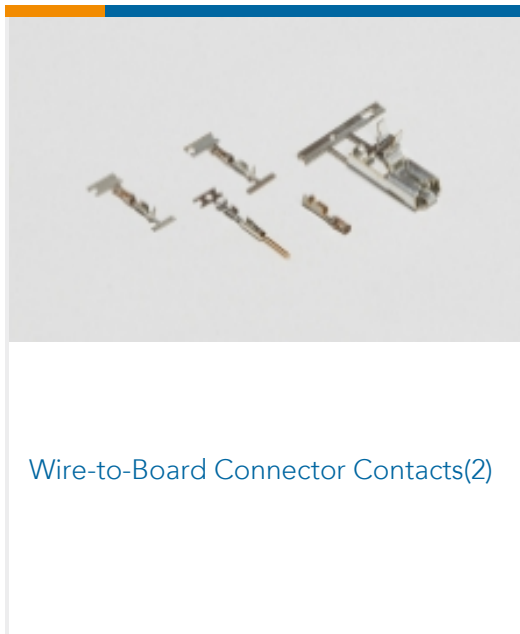

Wire-to-Board Connector Contacts(2)

### Customers Also Bought



TE Part #205843-1  
CPC RECPT ASSEMBLY SIZE 23-63

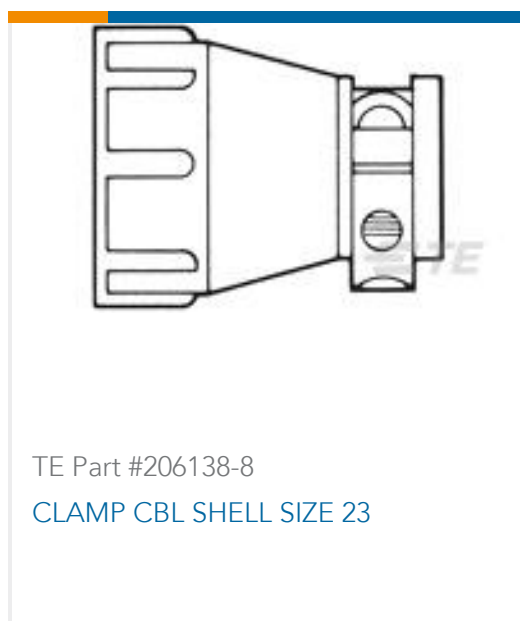

TE Part #206138-8  
CLAMP CBL SHELL SIZE 23



TE Part #205842-1  
CPC PLUG ASSEMBLY SIZE 23-63



TE Part #1-640385-0  
10P MTA156 HDR ASSY SQ R/A



TE Part #3-640602-4  
04P MTA156 CONN ASSY 24AWG LF



TE Part #34156  
PG SPD 22-16 COMM 22-18 MIL 10



TE Part #1658620-9  
40 NOVO MIL 15DP, LEAD FREE



TE Part #4-640601-0  
10P MTA156 CONN ASSY 22AWG LF



## Documents

### Product Drawings

[09P MTA156 CONN ASSY 22AWG LF](#)

English

### CAD Files

[3D PDF](#)

3D

Customer View Model

[ENG\\_CVM\\_CVM\\_3-640601-9\\_R.2d\\_dxf.zip](#)

English

Customer View Model

[ENG\\_CVM\\_CVM\\_3-640601-9\\_R.3d\\_igs.zip](#)

English

Customer View Model

[ENG\\_CVM\\_CVM\\_3-640601-9\\_R.3d\\_stp.zip](#)

English

By downloading the CAD file I accept and agree to the [Terms and Conditions](#) of use.

### Product Specifications

[Application Specification](#)

Japanese

[Application Specification](#)

English

[MTA 156 Ribbon Cable Connector Assemblies \(English And Spanish\)](#)

English

[MTA 156 Ribbon Cable Connector Assemblies \(English And Spanish\)](#)

Japanese

### Agency Approvals

[Agency Approval Document](#)

English