

3-640431-4 ✓ ACTIVE

MTA 156

TE Internal #: 3-640431-4

Rectangular Power Connectors, Connector Assembly, Receptacle, Wire-to-Board, 4 Position, 3.96 mm [.156 in] Centerline, Wire & Cable, UL 94V-2, MTA 156

[View on TE.com >](#)



Connectors > Power Connectors > Rectangular Power > Rectangular Power Connectors



Rectangular Power Connector Type: **Connector Assembly**

Connector & Housing Type: **Receptacle**

Connector System: **Wire-to-Board**

Number of Positions: **4**

Centerline (Pitch): **3.96 mm [.156 in]**

Features

Product Type Features

Compatible With Discrete Wire Type	Stranded
Rectangular Power Connector Type	Connector Assembly
Connector & Housing Type	Receptacle
Connector System	Wire-to-Board
Sealable	No
Connector & Contact Terminates To	Wire & Cable

Configuration Features

Number of Positions	4
Number of Power Positions	4
Number of Rows	1

Electrical Characteristics

Operating Voltage	600 VAC
-------------------	---------

Body Features

Cable Exit Angle	90°
------------------	-----



Connector Profile	Standard
Contact Features	
Contact Layout	Inline
Wire Contact Termination Area Plating Thickness	2.03 – 5.08 μm [80 – 200 μin]
Contact Mating Area Plating Material	Tin
Contact Base Material	Copper Alloy
Contact Current Rating (Max)	7 A
Contact Retention Within Housing	With
Contact Type	Receptacle
Wire Contact Termination Area Plating Material	Tin
Contact Mating Area Plating Material Thickness	2.03 – 5.08 μm [80 – 200 μin]
Termination Features	
Termination Method to Wire & Cable	Insulation Displacement (IDC)
Mechanical Attachment	
Strain Relief	With
Mating Retention	Without
Mating Alignment	Without
Contact Retention Type Within Housing	Locking Lance
PCB Mount Alignment	Without
Panel Mount Feature	Without
PCB Mount Retention	Without
Connector Mounting Type	Cable Mount (Free-Hanging)
Housing Features	
Wire & Cable IDC Installation Type	Closed End
Centerline (Pitch)	3.96 mm[.156 in]
Housing Color	Orange
Housing Material	Nylon
Dimensions	
Connector Height	9.02 mm[.355 in]
Product Length	15.85 mm[.624 in]
Compatible Insulation Diameter Range	2.41 mm[.095 in]
Wire Size	.8 – .9 mm ²



Usage Conditions

Operating Temperature Range	-55 – 105 °C[-67 – 221 °F]
-----------------------------	----------------------------

Operation/Application

Circuit Application	Power
---------------------	-------

Industry Standards

CSA Rating	Certified, LR 7189
UL Rating	Recognized
Agency/Standard	CSA, UL
Approved Standards	UL E28476
UL Flammability Rating	UL 94V-2
Glow Wire Rating	Standard Part - Not Glow Wire

Packaging Features

Packaging Quantity	250
Packaging Method	Bag & Box

Product Compliance

[For compliance documentation, visit the product page on TE.com>](#)

EU RoHS Directive 2011/65/EU	Compliant
EU ELV Directive 2000/53/EC	Compliant
China RoHS 2 Directive MIIT Order No 32, 2016	No Restricted Materials Above Threshold
EU REACH Regulation (EC) No. 1907/2006	Current ECHA Candidate List: JUNE 2023 (235) Candidate List Declared Against: JUNE 2023 (235) Does not contain REACH SVHC
Halogen Content	Low Halogen - Br, Cl, F, I < 900 ppm per homogenous material. Also BFR/CFR/PVC Free
Solder Process Capability	Not applicable for solder process capability

Product Compliance Disclaimer

This information is provided based on reasonable inquiry of our suppliers and represents our current actual knowledge based on the information they provided. This information is subject to change. The part numbers that TE has identified as EU RoHS compliant have a maximum concentration of 0.1% by weight in homogenous materials for lead, hexavalent chromium, mercury, PBB, PBDE, DBP, BBP, DEHP, DIBP, and 0.01% for cadmium, or qualify for an exemption to these limits as defined in the Annexes of Directive 2011/65/EU (RoHS2). Finished electrical and electronic equipment products will be CE marked as required by Directive 2011/65/EU. Components may not be CE marked. Additionally, the part numbers that TE has identified as EU ELV compliant have a maximum concentration of 0.1% by weight in homogenous materials for lead, hexavalent chromium, and mercury, and 0.01% for cadmium, or qualify for an exemption to these limits

as defined in the Annexes of Directive 2000/53/EC (ELV). Regarding the REACH Regulation, the information TE provides on SVHC in articles for this part number is based on the latest European Chemicals Agency (ECHA) 'Guidance on requirements for substances in articles' posted at this URL: <https://echa.europa.eu/guidance-documents/guidance-on-reach>

Compatible Parts



TE Part # 58074-1
MTA 50/100/156 MANUAL TOOL FRAME



TE Part # 59804-1
MAINTENANCE TOOL



TE Part # 3-644613-4
04P MTA156 HDR RA PO WO PEG LF



TE Part # 640387-4
04P MTA156 HDR ASSY SQ R/A



TE Part # 640389-4
04P MTA156 HDR ASSY SQ R/A F/L



TE Part # 644753-4
04P MTA156 HDR ASSY RN STR F/L



TE Part # 2-647127-4
04P MTA156 SHRD HDR ASSY LF



TE Part # 640551-4
04P MTA156 COVER



TE Part # 640388-4
04P MTA156 HDR ASSY RN STR F/L



TE Part # 640643-4
04P MTA156 COVER F/T



TE Part # 640445-4
04P MTA156 HDR ASSY FL/STR SN



TE Part # 644752-4
04P MTA156 HDR ASSY SQ STR F/L



TE Part # 640383-4
04P MTA156 HDR ASSY STR SQ SN



TE Part # 3-644615-4
04P MTA156 POL HDR ASSY LF



TE Part # 2-647123-4
04P MTA156 SHRD HDR ASSY SQ SN



TE Part # 643071-4
04P MTA156 FD-THRU COVER



Also in the Series | **MTA 156**

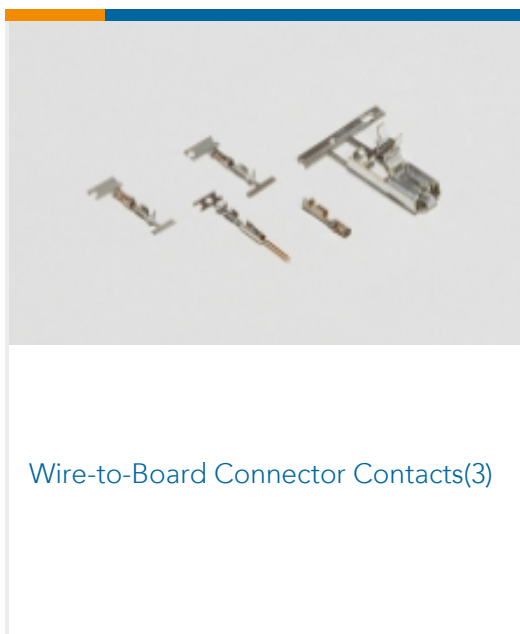
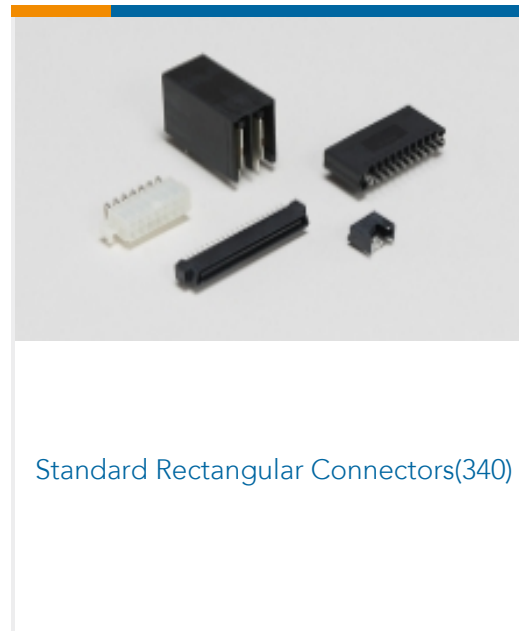
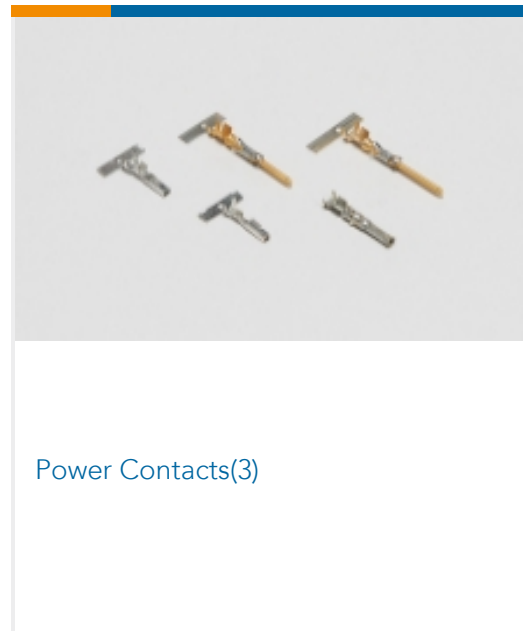
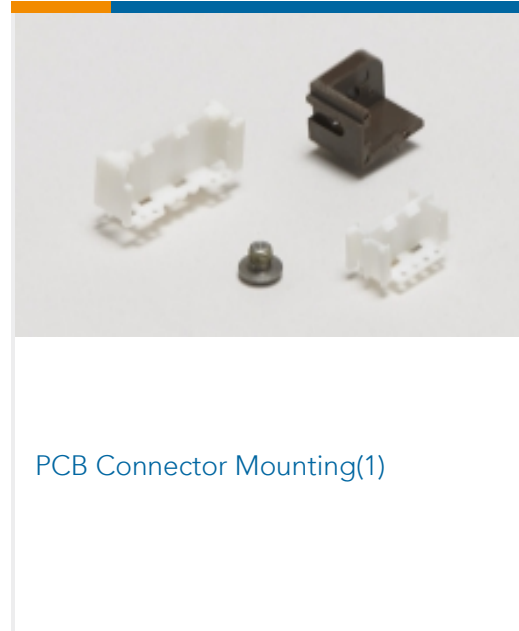
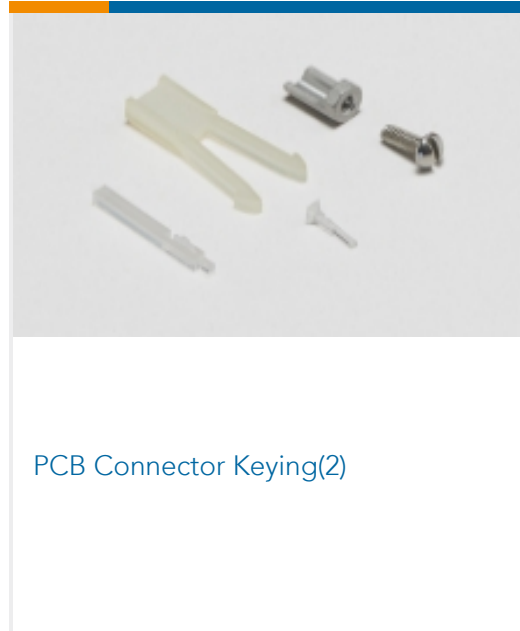
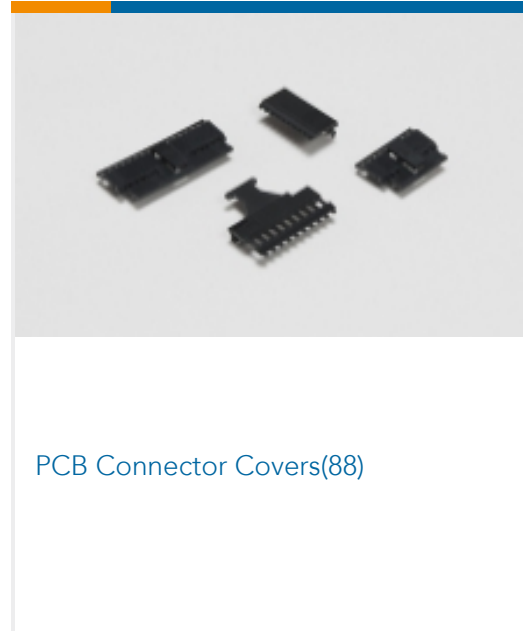
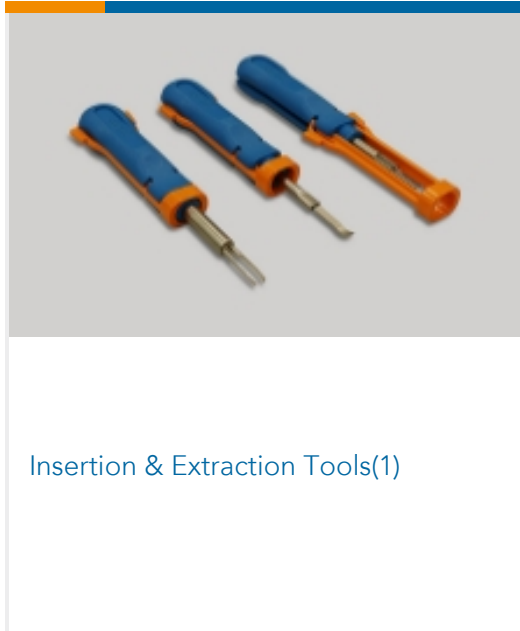

Customers Also Bought

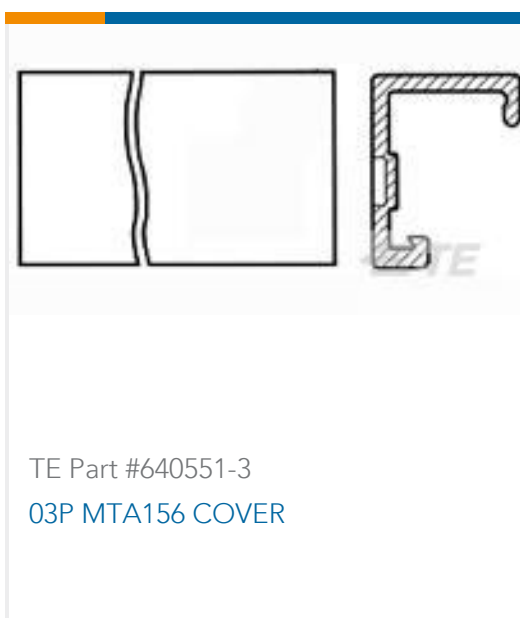



TE Part #964310-1
TIMER, RECEPTACLE AND TAB



TE Part #1241380-2
AMP MCP 1.5K, CONTACT, SWS



TE Part #5-963716-1
MQS0,63 Sn tab LL unseal. 0,5-0,75



TE Part #5052892055
RNF-100-1/16-0-STK

Documents

Product Drawings

[04P MTA156 CONN ASSY 18AWG ORA](#)

English

CAD Files

[3D PDF](#)

3D

Customer View Model

[ENG_CVM_CVM_3-640431-4_L.2d_dxf.zip](#)

English

Customer View Model

[ENG_CVM_CVM_3-640431-4_L.3d_igs.zip](#)

English

Customer View Model

[ENG_CVM_CVM_3-640431-4_L.3d_stp.zip](#)

English

By downloading the CAD file I accept and agree to the [Terms and Conditions](#) of use.

Product Specifications

[Application Specification](#)

Japanese

[Application Specification](#)

English

[MTA 156 Ribbon Cable Connector Assemblies \(English And Spanish\)](#)

English

[MTA 156 Ribbon Cable Connector Assemblies \(English And Spanish\)](#)

Japanese

Product Environmental Compliance

[Product Compliance](#)

English

[Product Compliance](#)

English

Agency Approvals

[CSA Certificate](#)

3-640431-4

Rectangular Power Connectors, Connector Assembly, Receptacle, Wire-to-Board, 4
Position, 3.96 mm [.156 in] Centerline, Wire & Cable, UL 94V-2, MTA 156



English