

3-520133-2 ✓ ACTIVE

Ultra-Fast | Ultra-Fast 250

TE Internal #: 3-520133-2

Quick Disconnects, Receptacle, 16 – 14 AWG Wire Size, 1.31 – 2.08 mm² Wire Size, Mating Tab Width 6.35 mm [.25 in], Flag, Brass, Ultra-Fast 250

[View on TE.com >](#)



Terminals & Splices > Quick Disconnects

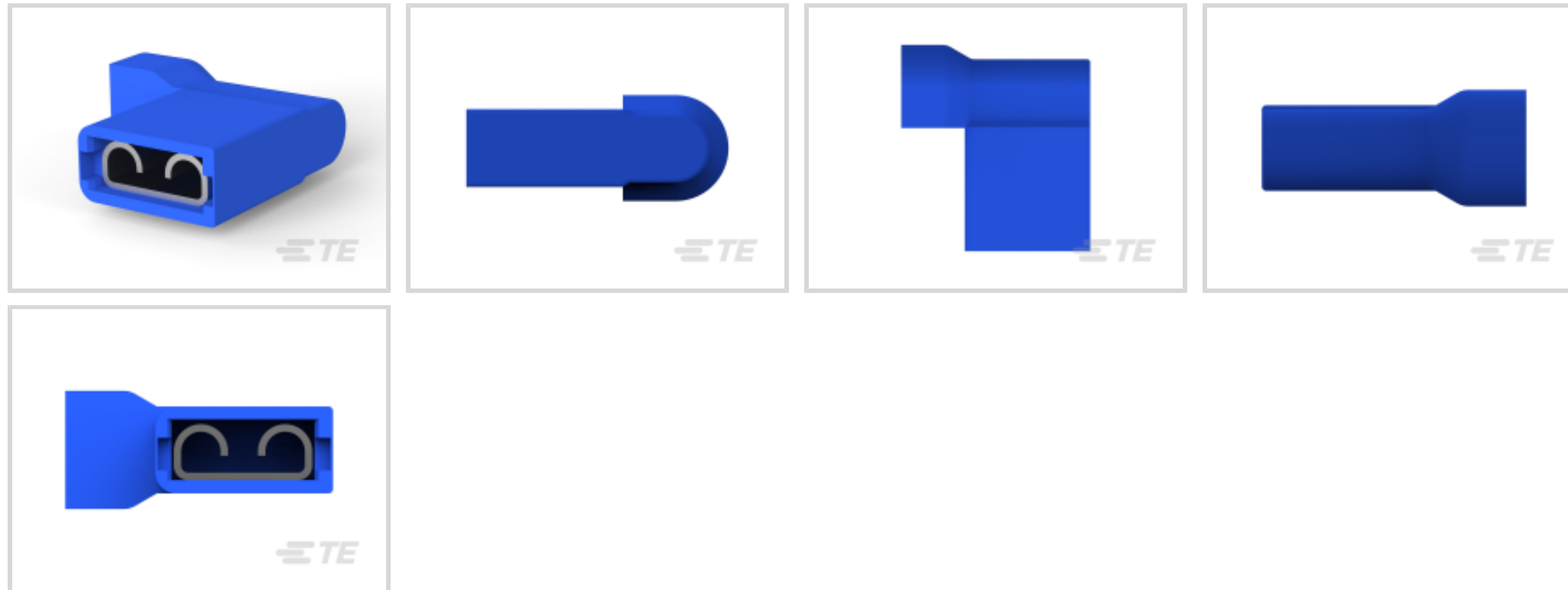

Quick Disconnect Terminal Type: **Receptacle**

Wire Size: 1.31 – 2.08 mm²

Mating Tab Width: 6.35 mm [.25 in]

Mating Tab Thickness: .81 mm [.032 in]

Features

Product Type Features

Insertion Force	Low
-----------------	-----

Configuration Features

Connection Capacity	Single
---------------------	--------

Compatible With Wire & Cable Type	Discrete Wire
-----------------------------------	---------------

Electrical Characteristics

Voltage Rating	600 V
----------------	-------

Body Features

Insulation Material	Nylon
---------------------	-------

Contact Features

Quick Disconnect Terminal Type	Receptacle
--------------------------------	------------

Mating Tab Width	6.35 mm [.25 in]
------------------	------------------

Mating Tab Thickness	.81 mm [.032 in]
----------------------	------------------

Terminal Orientation	Flag
----------------------	------

Contact Base Material	Brass
-----------------------	-------



Terminal Plating Material	Tin
Crimp Type	F-Crimp
Barrel Type	Closed

Termination Features

Product Terminates To	Wire & Cable
-----------------------	--------------

Mechanical Attachment

Wire Insulation Support	With
Mating Retention Type	Dimple

Dimensions

Terminal Material Thickness	.41 mm[.016 in]
Product Length	14.73 mm[.58 in]
Compatible Insulation Diameter Range	4.7 mm[.185 in]
Wire Size	1.31 – 2.08 mm ²

Usage Conditions

Insulation Option	Fully Insulated
Operating Temperature Range	-40 – 110 °C[-40 – 230 °F]

Industry Standards

Agency/Standard	UL
Approved Standards	CSA LR7189, UL E66717
UL Flammability Rating	UL 94V-2

Packaging Features

Packaging Quantity	1000
Packaging Method	Loose Piece/Carton

Other

Barrel Color	Blue
--------------	------

Product Compliance

[For compliance documentation, visit the product page on TE.com>](#)

EU RoHS Directive 2011/65/EU	Compliant
EU ELV Directive 2000/53/EC	Compliant
China RoHS 2 Directive MIIT Order No 32, 2016	No Restricted Materials Above Threshold
EU REACH Regulation (EC) No. 1907/2006	



Current ECHA Candidate List: JUNE 2023 (235)
 Candidate List Declared Against: JUNE 2023 (235)
 Does not contain REACH SVHC

Halogen Content Low Halogen - Br, Cl, F, I < 900 ppm per homogenous material. Also BFR/CFR/PVC Free

Solder Process Capability Not applicable for solder process capability

Product Compliance Disclaimer

This information is provided based on reasonable inquiry of our suppliers and represents our current actual knowledge based on the information they provided. This information is subject to change. The part numbers that TE has identified as EU RoHS compliant have a maximum concentration of 0.1% by weight in homogenous materials for lead, hexavalent chromium, mercury, PBB, PBDE, DBP, BBP, DEHP, DIBP, and 0.01% for cadmium, or qualify for an exemption to these limits as defined in the Annexes of Directive 2011/65/EU (RoHS2). Finished electrical and electronic equipment products will be CE marked as required by Directive 2011/65/EU. Components may not be CE marked. Additionally, the part numbers that TE has identified as EU ELV compliant have a maximum concentration of 0.1% by weight in homogenous materials for lead, hexavalent chromium, and mercury, and 0.01% for cadmium, or qualify for an exemption to these limits as defined in the Annexes of Directive 2000/53/EC (ELV). Regarding the REACH Regulation, the information TE provides on SVHC in articles for this part number is based on the latest European Chemicals Agency (ECHA) 'Guidance on requirements for substances in articles' posted at this URL: <https://echa.europa.eu/guidance-documents/guidance-on-reach>

Compatible Parts



Also in the Series | Ultra-Fast 250

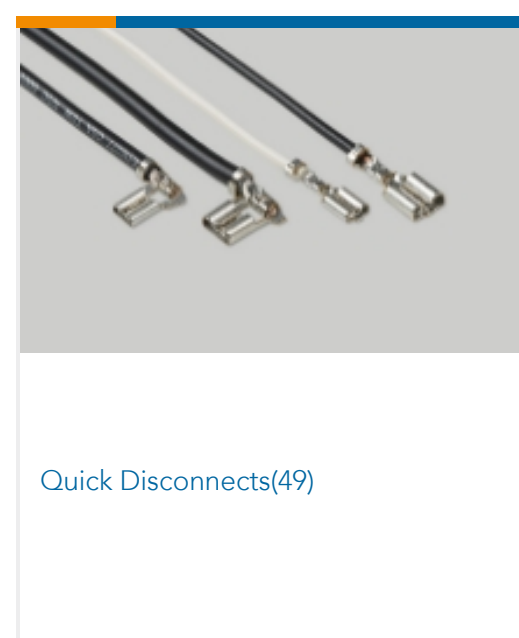
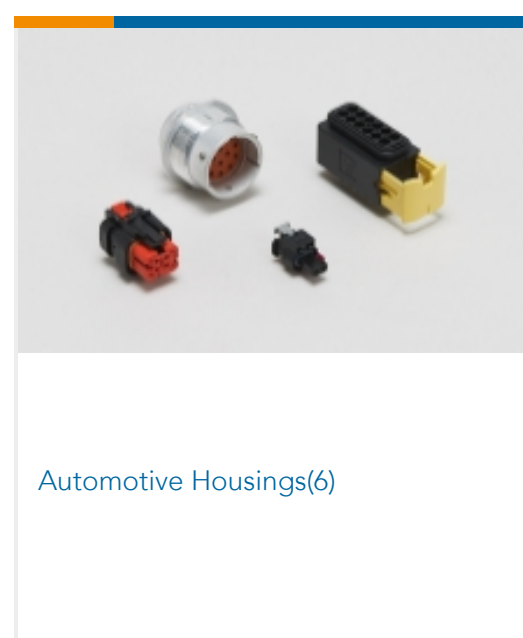
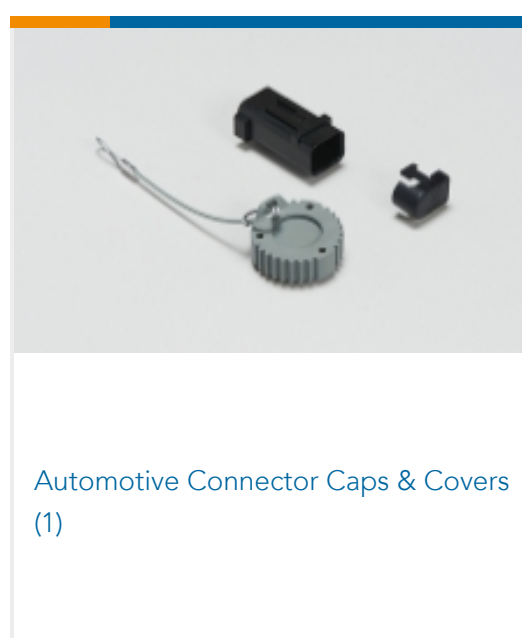

Customers Also Bought

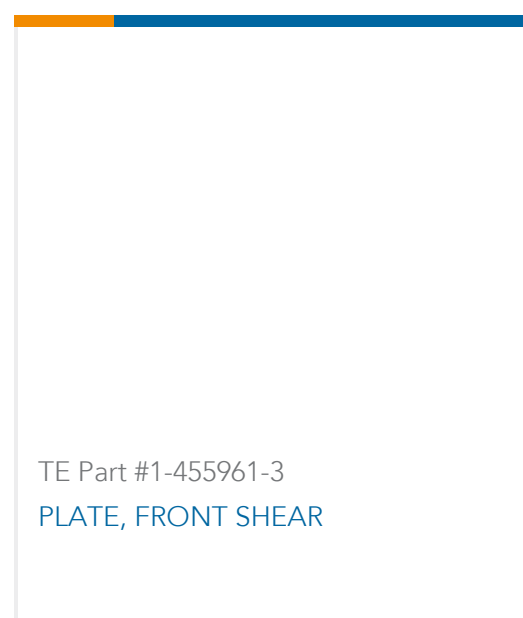
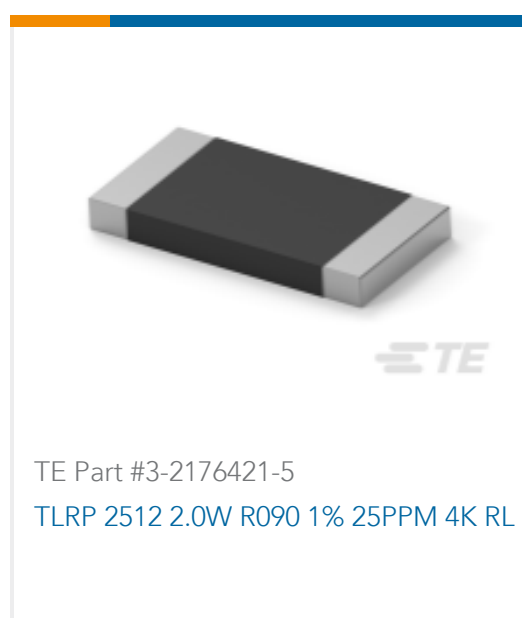
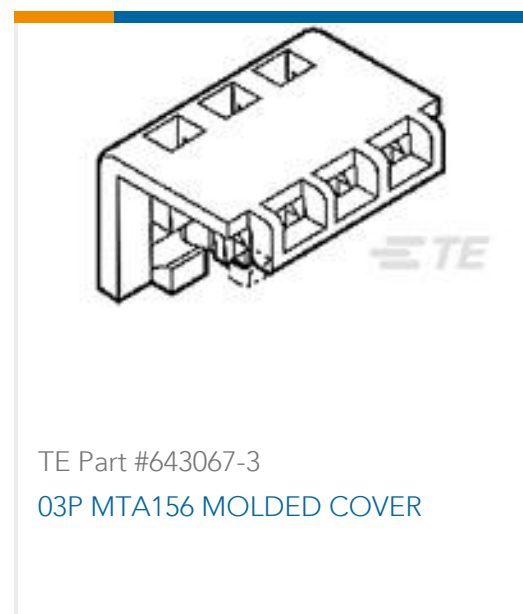

Documents

Product Drawings

[ULTRA-FAST 250 ASY REC 16-14 AWG TPBR](#)

English

CAD Files

[3D PDF](#)

3D

Customer View Model

[ENG_CVM_CVM_3-520133-2_P.2d_dxf.zip](#)

English

Customer View Model

[ENG_CVM_CVM_3-520133-2_P.3d_igs.zip](#)

English

Customer View Model

[ENG_CVM_CVM_3-520133-2_P.3d_stp.zip](#)

English

By downloading the CAD file I accept and agree to the [Terms and Conditions](#) of use.

Datasheets & Catalog Pages



Ultra-Fast and Ultra Fast Plus

English

Product Specifications

Application Specification

English

Product Environmental Compliance

Product Compliance Document

English

Product Compliance Document

English

Agency Approvals

UL

English