

3-2106751-3 ✓ ACTIVE

LUMAWISE | Insulation Displacement Connectors Closed End

TE Internal #: 3-2106751-3

Poke-In Connectors, Wire-to-Board, 3 Position, 4 in [.16 mm]

Centerline, Printed Circuit Board, Insulation Displacement Connectors Closed End

[View on TE.com >](#)



Connectors > Lighting Connectors > Poke-In Connectors



Connector System: **Wire-to-Board**

Number of Positions: **3**

Centerline (Pitch): **.16 mm [4 in]**

Connector & Contact Terminates To: **Printed Circuit Board**

Connector Height: **.23 mm [5.8 in]**

Features

Product Type Features

Connector System	Wire-to-Board
Connector & Contact Terminates To	Printed Circuit Board

Configuration Features

Number of Positions	3
---------------------	---

Contact Features

Contact Current Rating (Max)	6 A
------------------------------	-----

Termination Features

Termination Method to Printed Circuit Board	Through Hole - Solder
---	-----------------------

Mechanical Attachment

Connector Mounting Type	Board Mount
-------------------------	-------------

Housing Features

Centerline (Pitch)	.16 mm[4 in]
--------------------	--------------

Dimensions



Connector Height	.23 mm[5.8 in]
------------------	----------------

Wire Size	24 – 22 AWG
-----------	-------------

Usage Conditions

Operating Temperature Range	-40 – 105 °C[-40 – 221 °F]
-----------------------------	----------------------------

Operation/Application

Circuit Application	Power
---------------------	-------

Product Compliance

[For compliance documentation, visit the product page on TE.com>](#)

EU RoHS Directive 2011/65/EU	Compliant
------------------------------	-----------

EU ELV Directive 2000/53/EC	Compliant
-----------------------------	-----------

China RoHS 2 Directive MIIT Order No 32, 2016	No Restricted Materials Above Threshold
---	---

EU REACH Regulation (EC) No. 1907/2006	Current ECHA Candidate List: JUNE 2023 (235) Candidate List Declared Against: JUNE 2023 (235) Does not contain REACH SVHC
--	---

Halogen Content	Low Halogen - Br, Cl, F, I < 900 ppm per homogenous material. Also BFR/CFR/PVC Free
-----------------	---

Solder Process Capability	Reflow solder capable to 245°C
---------------------------	--------------------------------

Product Compliance Disclaimer

This information is provided based on reasonable inquiry of our suppliers and represents our current actual knowledge based on the information they provided. This information is subject to change. The part numbers that TE has identified as EU RoHS compliant have a maximum concentration of 0.1% by weight in homogenous materials for lead, hexavalent chromium, mercury, PBB, PBDE, DBP, BBP, DEHP, DIBP, and 0.01% for cadmium, or qualify for an exemption to these limits as defined in the Annexes of Directive 2011/65/EU (RoHS2). Finished electrical and electronic equipment products will be CE marked as required by Directive 2011/65/EU. Components may not be CE marked. Additionally, the part numbers that TE has identified as EU ELV compliant have a maximum concentration of 0.1% by weight in homogenous materials for lead, hexavalent chromium, and mercury, and 0.01% for cadmium, or qualify for an exemption to these limits as defined in the Annexes of Directive 2000/53/EC (ELV). Regarding the REACH Regulation, the information TE provides on SVHC in articles for this part number is based on the latest European Chemicals Agency (ECHA) 'Guidance on requirements for substances in articles' posted at this URL: <https://echa.europa.eu/guidance-documents/guidance-on-reach>

Compatible Parts



Also in the Series | Insulation Displacement Connectors Closed End



Customers Also Bought

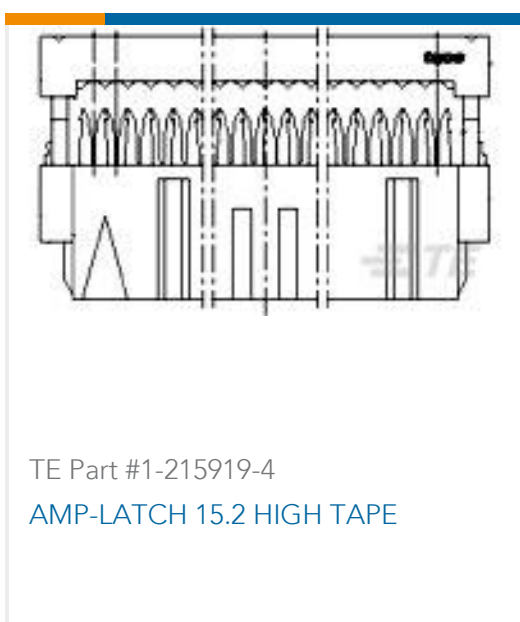

Documents

Product Drawings

Connector, Thru Hole-IDC, 3 pos, 24AWG

English

CAD Files

3D PDF

3D



Customer View Model

[ENG_CVM_CVM_3-2106751-3_B.2d_dxf.zip](#)

English

Customer View Model

[ENG_CVM_CVM_3-2106751-3_B.3d_igs.zip](#)

English

Customer View Model

[ENG_CVM_CVM_3-2106751-3_B.3d_stp.zip](#)

English

By downloading the CAD file I accept and agree to the [Terms and Conditions](#) of use.

Datasheets & Catalog Pages

[IDC_SSL_CONNECTOR](#)

English

Product Specifications

[Application Specification](#)

English

Agency Approvals

[Agency Approval Document](#)

English