



CGS | CGS TE

TE Internal #: 3-1879453-3

470 Ω, Wire Wound, Power Resistor, 350 x 60 x 119 mm, 2 Termination, Loose Piece - Box, 5 %, 1000 W, ±440 ppm/°C, Solder Lug Termination, CGS TE

[View on TE.com >](#)

Passive Components > Resistors > Chassis Mount Resistors > Wirewound Resistor: Mineral, 2.5 Kw



Resistor Type: **Power Resistor**

Passive Component Dimensions: **350 x 60 x 119 mm**

Number of Terminations: **2**

Packaging Method: **Loose Piece - Box**

Passive Component Tolerance: **5 %**

[All Wirewound Resistor: Mineral, 2.5 Kw \(685\)](#)

Features

Product Type Features

Resistor Type	Power Resistor
Element Type	Wire Wound

Configuration Features

Number of Resistors	1
---------------------	---

Electrical Characteristics

Voltage Rating	2500 V
Passive Component Tolerance	5 %
Resistance Class	Up to 1kΩ
Resistance Value	470 Ω
Power Rating	1000 W

Termination Features

Number of Terminations	2
Chassis Mount Resistor Termination Type	Solder Lug

Mechanical Attachment

Chassis Mount Resistor Mount Style	Bracket
------------------------------------	---------

Dimensions

--	--

Passive Component Dimensions	350 x 60 x 119 mm
------------------------------	-------------------

Usage Conditions

Operating Temperature Range	-55 – 155 $^{\circ}\text{C}$
Temperature Coefficient	± 440 ppm/ $^{\circ}\text{C}$

Packaging Features

Packaging Method	Loose Piece - Box
------------------	-------------------

Product Compliance

[For compliance documentation, visit the product page on TE.com>](#)

EU RoHS Directive 2011/65/EU	Compliant
EU ELV Directive 2000/53/EC	Compliant
China RoHS 2 Directive MIIT Order No 32, 2016	No Restricted Materials Above Threshold
EU REACH Regulation (EC) No. 1907/2006	Current ECHA Candidate List: JUNE 2023 (235) Candidate List Declared Against: JUNE 2023 (235) Does not contain REACH SVHC
Halogen Content	Low Halogen - Br, Cl, F, I < 900 ppm per homogenous material. Also BFR/CFR/PVC Free
Solder Process Capability	Not applicable for solder process capability

Product Compliance Disclaimer

This information is provided based on reasonable inquiry of our suppliers and represents our current actual knowledge based on the information they provided. This information is subject to change. The part numbers that TE has identified as EU RoHS compliant have a maximum concentration of 0.1% by weight in homogenous materials for lead, hexavalent chromium, mercury, PBB, PBDE, DBP, BBP, DEHP, DIBP, and 0.01% for cadmium, or qualify for an exemption to these limits as defined in the Annexes of Directive 2011/65/EU (RoHS2). Finished electrical and electronic equipment products will be CE marked as required by Directive 2011/65/EU. Components may not be CE marked. Additionally, the part numbers that TE has identified as EU ELV compliant have a maximum concentration of 0.1% by weight in homogenous materials for lead, hexavalent chromium, and mercury, and 0.01% for cadmium, or qualify for an exemption to these limits as defined in the Annexes of Directive 2000/53/EC (ELV). Regarding the REACH Regulation, the information TE provides on SVHC in articles for this part number is based on the latest European Chemicals Agency (ECHA) 'Guidance on requirements for substances in articles' posted at this URL: <https://echa.europa.eu/guidance-documents/guidance-on-reach>

Compatible Parts



Also in the Series | CGS TE



Customers Also Bought

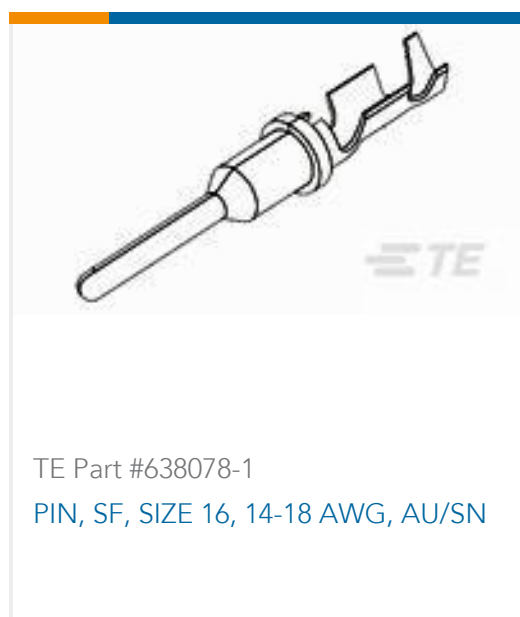
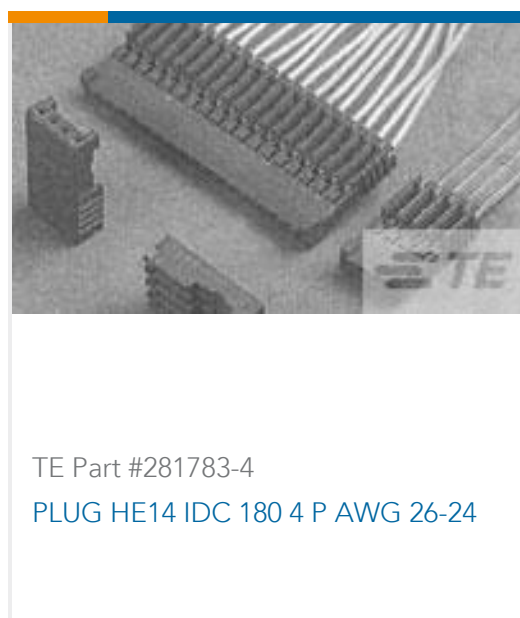



Documents

Product Drawings

[TE 1000W 470R 5% Bracket](#)

English

CAD Files

[3D PDF](#)

3D

Customer View Model

[ENG_CVM_CVM_3-1879453-3_BB.2d_dxf.zip](#)

English

Customer View Model

[ENG_CVM_CVM_3-1879453-3_BB.3d_igs.zip](#)

English

Customer View Model

[ENG_CVM_CVM_3-1879453-3_BB.3d_stp.zip](#)

English

By downloading the CAD file I accept and agree to the [Terms and Conditions](#) of use.

Datasheets & Catalog Pages

[4-1773460-6_RESISTIVE_SOLUTIONS_RAIL](#)

English

[1309350_PASSIVE_COMPONENT](#)

English

[8-1773459-4_POWER_FILTERING_AND_RESISTIVE_SOLUTIONS_FOR_ELEVATORS_AND_ESCALATORS](#)

English

[High Power Wire wound Resistor Type TE Series](#)

English