

3-179694-0 ✓ ACTIVE

AMP CT

TE Internal #: 3-179694-0

Connector Assembly, Receptacle, Wire-to-Board, 10 Position, .079 in [2 mm] Centerline, Insulation Displacement (IDC), 1 Row, Gray, AMP CT

[View on TE.com >](#)



[Connectors >](#) [PCB Connectors >](#) [Wire-to-Board Connectors >](#) [Wire-to-Board Connector Assemblies & Housings >](#)

AMP COMMON TERMINATION HOUSINGS

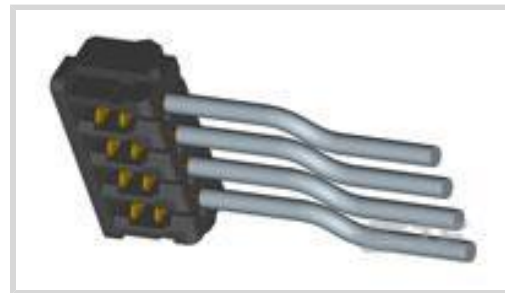

Connector Product Type: **Connector Assembly**

Connector & Housing Type: **Receptacle**

Connector System: **Wire-to-Board**

Number of Positions: **10**

Centerline (Pitch): **2 mm [.079 in]**

[All AMP COMMON TERMINATION HOUSINGS \(176\)](#)

Features

Product Type Features

Connector Product Type	Connector Assembly
Connector & Housing Type	Receptacle
Connector System	Wire-to-Board
Sealable	No
Connector & Contact Terminates To	Wire & Cable

Configuration Features

Number of Positions	10
Number of Rows	1

Body Features

Primary Product Color	Gray
-----------------------	------

Contact Features

Contact Current Rating (Max)	3 A
------------------------------	-----

Termination Features

Termination Method to Wire & Cable	Insulation Displacement (IDC)
------------------------------------	-------------------------------

Mechanical Attachment



Mating Retention Type	Lock
Mating Retention	With
Connector Mounting Type	Cable Mount (Free-Hanging)

Housing Features

Housing Material	PBT GF
Centerline (Pitch)	2 mm[.079 in]

Usage Conditions

Operating Temperature Range	-30 – 105 °C[-22 – 221 °F]
-----------------------------	----------------------------

Operation/Application

Circuit Application	Power & Signal
---------------------	----------------

Product Compliance

[For compliance documentation, visit the product page on TE.com>](#)

EU RoHS Directive 2011/65/EU	Compliant
EU ELV Directive 2000/53/EC	Compliant
China RoHS 2 Directive MIIT Order No 32, 2016	No Restricted Materials Above Threshold
EU REACH Regulation (EC) No. 1907/2006	Current ECHA Candidate List: JUNE 2023 (235) Candidate List Declared Against: JUNE 2023 (235) Does not contain REACH SVHC
Halogen Content	Not Low Halogen - contains Br or Cl > 900 ppm.
Solder Process Capability	Not applicable for solder process capability

Product Compliance Disclaimer

This information is provided based on reasonable inquiry of our suppliers and represents our current actual knowledge based on the information they provided. This information is subject to change. The part numbers that TE has identified as EU RoHS compliant have a maximum concentration of 0.1% by weight in homogenous materials for lead, hexavalent chromium, mercury, PBB, PBDE, DBP, BBP, DEHP, DIBP, and 0.01% for cadmium, or qualify for an exemption to these limits as defined in the Annexes of Directive 2011/65/EU (RoHS2). Finished electrical and electronic equipment products will be CE marked as required by Directive 2011/65/EU. Components may not be CE marked. Additionally, the part numbers that TE has identified as EU ELV compliant have a maximum concentration of 0.1% by weight in homogenous materials for lead, hexavalent chromium, and mercury, and 0.01% for cadmium, or qualify for an exemption to these limits as defined in the Annexes of Directive 2000/53/EC (ELV). Regarding the REACH Regulation, the information TE provides on SVHC in articles for this part number is based on the latest European Chemicals Agency (ECHA) 'Guidance on requirements for substances in articles' posted at this URL: <https://echa.europa.eu/guidance-documents/guidance-on-reach>

Compatible Parts



Also in the Series | **AMP CT**

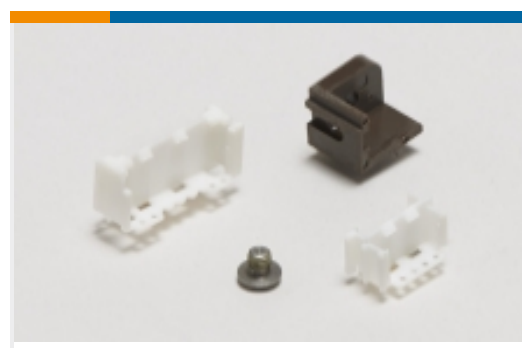

PCB Connector Mounting(46)

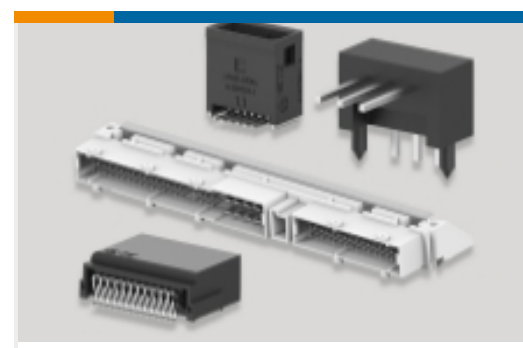

PCB Headers & Receptacles(756)

Wire-to-Board Connector Assemblies
& Housings(256)

Wire-to-Board Connector Contacts(8)

Customers Also Bought

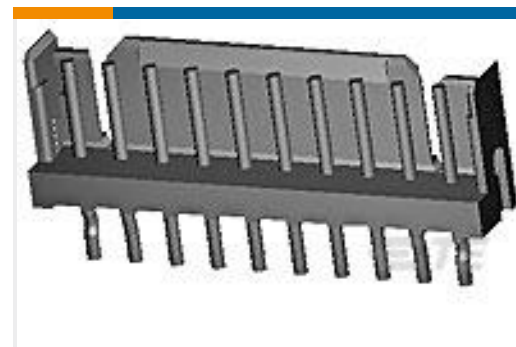
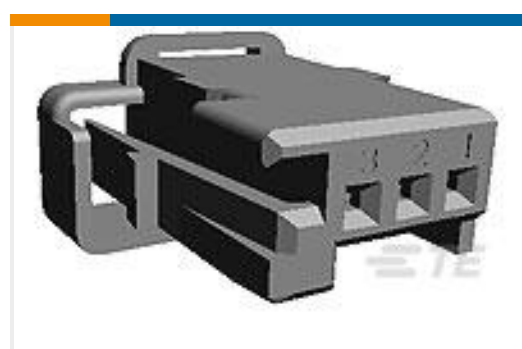
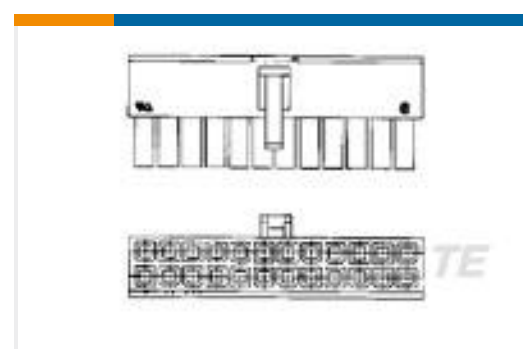
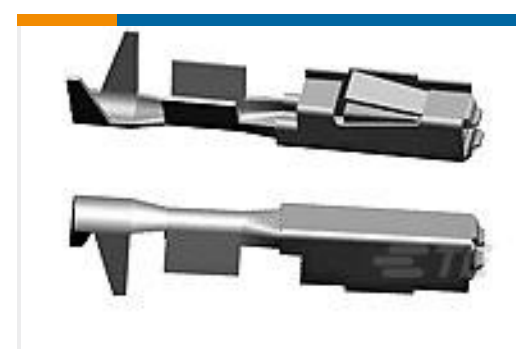
TE Part #9-1393211-0
T92S11D12-24TE Part #1375820-2
CST-100 II HOUSING 2 POSTE Part #292161-8
CT P/HDR ASSY V 8P W/KINK NATTE Part #173977-8
AMP COMMON TERMINATION
HOUSINGSTE Part #953697-1
3POS MOS RECTE Part #1-794954-0
10P RCPT VAL-U-LOK V2TE Part #1586852-1
04P UMNL PLUG HSG, GWTE Part #5-928999-1
MQS0,63 Sn rec LL unseal. >0,2-0,35

Documents

CAD Files

3D PDF

3D

Customer View Model

[ENG_CVM_CVM_3-179694-0_F.2d_dxf.zip](#)

English

Customer View Model

[ENG_CVM_CVM_3-179694-0_F.3d_igs.zip](#)

English

Customer View Model

[ENG_CVM_CVM_3-179694-0_F.3d_stp.zip](#)

English

By downloading the CAD file I accept and agree to the [Terms and Conditions](#) of use.

Datasheets & Catalog Pages

[POWER_CONNECTORS_CATALOG_SEC02_CABLE_MOUNTED](#)

English

3-179694-0

Connector Assembly, Receptacle, Wire-to-Board, 10 Position, .079 in [2 mm]
Centerline, Insulation Displacement (IDC), 1 Row, Gray, AMP CT



[Product Specifications](#)

[Application Specification](#)

English