

3-1447221-5 ✓ ACTIVE

AMP | SUPERSEAL 1.0mm

TE Internal #: 3-1447221-5

Automotive Terminals, Receptacle, 22 AWG Wire Size, .3 mm² Wire Size, Sealable, Family Seal, Tin (Sn) Interface Plating, SUPERSEAL 1.0mm

[View on TE.com >](#)



Terminals & Splices > Automotive Terminals > SUPERSEAL Connector Contacts: 1.0 mm

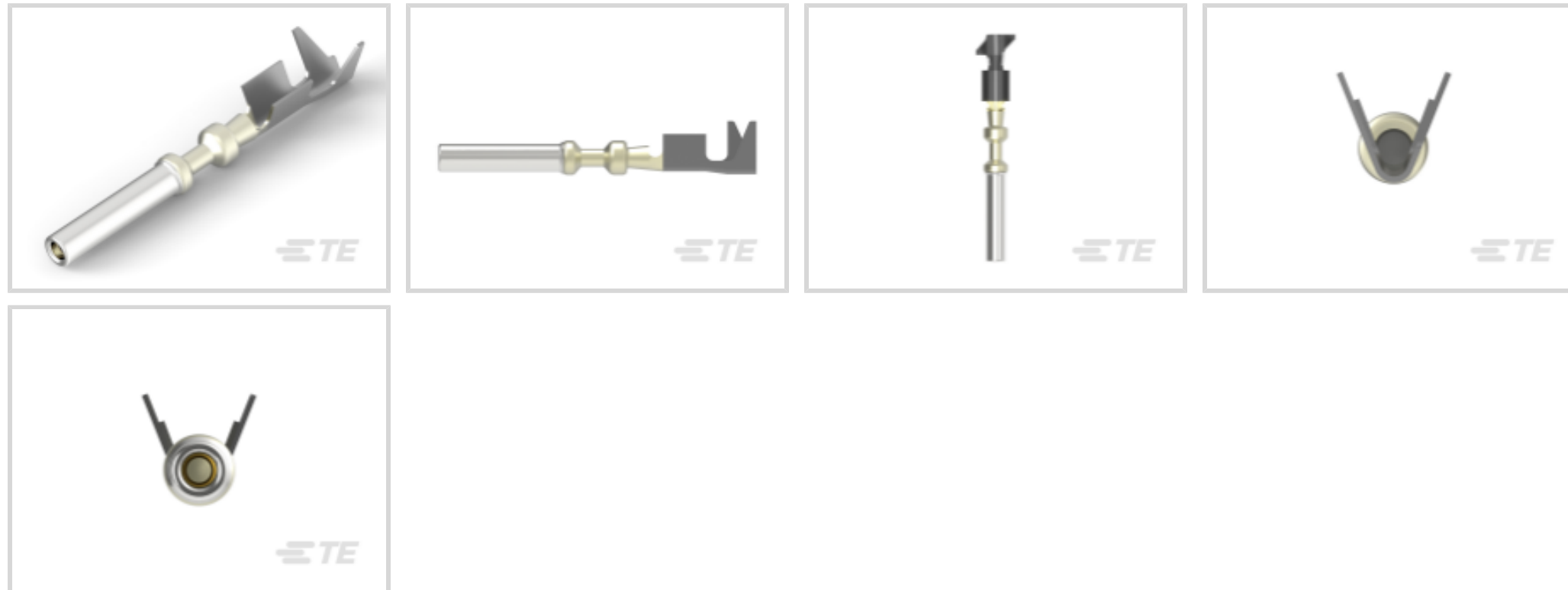

Terminal Type: **Receptacle**

Wire Size: **.3 mm²**

Sealable: **Yes**

Terminal Seal Type: **Family Seal**

[All SUPERSEAL Connector Contacts: 1.0 mm \(6\)](#)

Features

Product Type Features

Sealable	Yes
Primary Locking Feature	Clean Body

Body Features

Terminal Seal Type	Family Seal
--------------------	-------------

Contact Features

Contact Size	1mm
Contact Fabrication	Stamped & Formed
Crimp Type	F-Crimp
Terminal Type	Receptacle
Interface Plating	Tin (Sn)

Termination Features

Termination Method to Wire & Cable	Crimp
Product Terminates To	Wire



Dimensions

Wire Size	.3 mm ²
Wire Size Search	22 AWG

Usage Conditions

Insulation Option	Uninsulated
-------------------	-------------

Packaging Features

Packaging Quantity	7000
Packaging Method	Reel

Product Compliance

[For compliance documentation, visit the product page on TE.com>](#)

EU RoHS Directive 2011/65/EU	Compliant
EU ELV Directive 2000/53/EC	Compliant
China RoHS 2 Directive MIIT Order No 32, 2016	No Restricted Materials Above Threshold
EU REACH Regulation (EC) No. 1907/2006	Current ECHA Candidate List: JUNE 2023 (235) Candidate List Declared Against: JUNE 2023 (235) Does not contain REACH SVHC
Halogen Content	Low Halogen - Br, Cl, F, I < 900 ppm per homogenous material. Also BFR/CFR/PVC Free
Solder Process Capability	Not applicable for solder process capability

Product Compliance Disclaimer

This information is provided based on reasonable inquiry of our suppliers and represents our current actual knowledge based on the information they provided. This information is subject to change. The part numbers that TE has identified as EU RoHS compliant have a maximum concentration of 0.1% by weight in homogenous materials for lead, hexavalent chromium, mercury, PBB, PBDE, DBP, BBP, DEHP, DIBP, and 0.01% for cadmium, or qualify for an exemption to these limits as defined in the Annexes of Directive 2011/65/EU (RoHS2). Finished electrical and electronic equipment products will be CE marked as required by Directive 2011/65/EU. Components may not be CE marked. Additionally, the part numbers that TE has identified as EU ELV compliant have a maximum concentration of 0.1% by weight in homogenous materials for lead, hexavalent chromium, and mercury, and 0.01% for cadmium, or qualify for an exemption to these limits as defined in the Annexes of Directive 2000/53/EC (ELV). Regarding the REACH Regulation, the information TE provides on SVHC in articles for this part number is based on the latest European Chemicals Agency (ECHA) 'Guidance on requirements for substances in articles' posted at this URL: <https://echa.europa.eu/guidance-documents/guidance-on-reach>

Compatible Parts



Also in the Series | SUPERSEAL 1.0mm

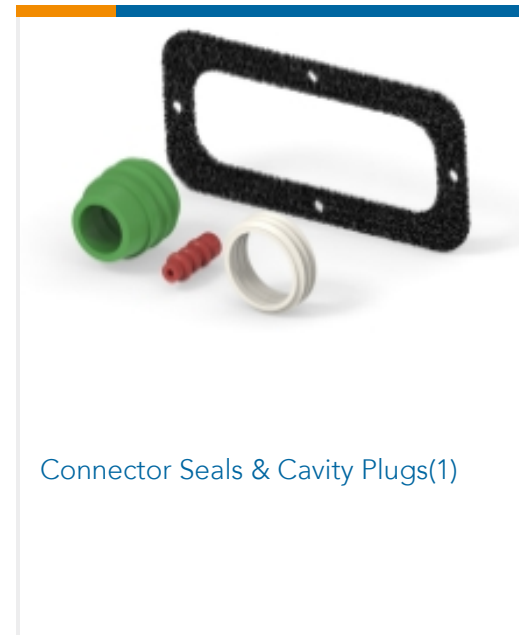
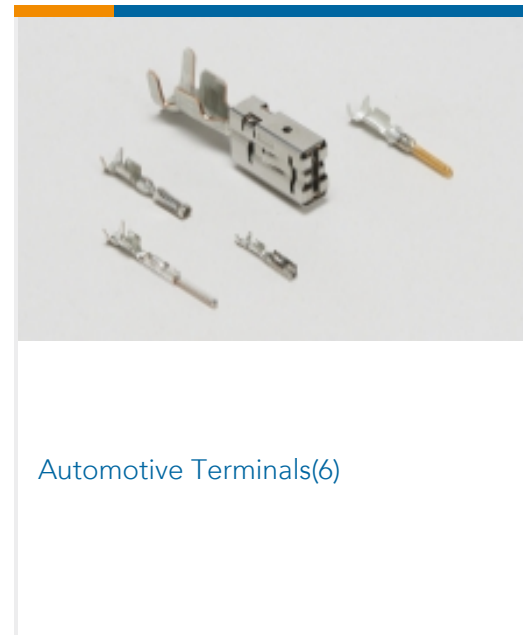
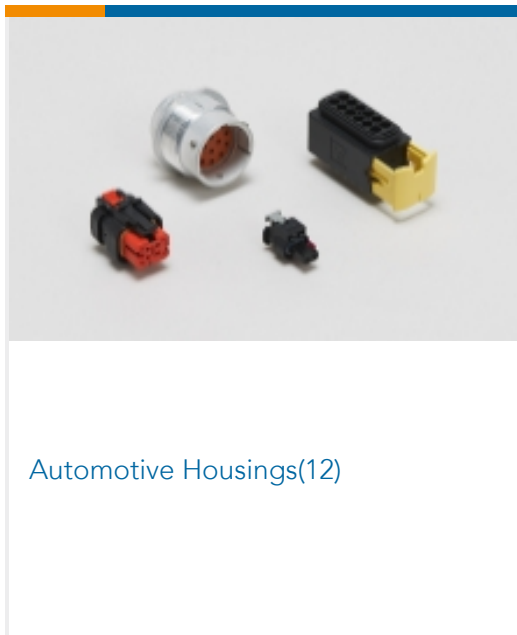

Customers Also Bought

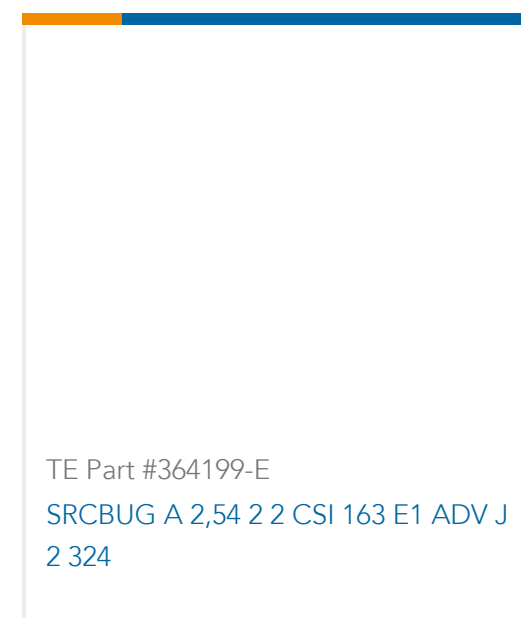
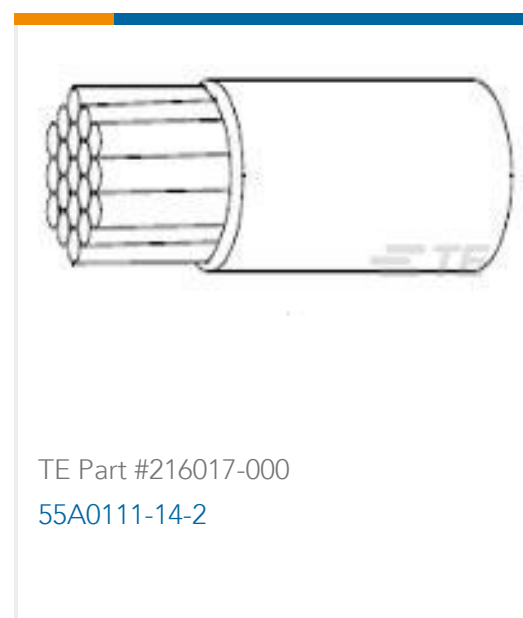
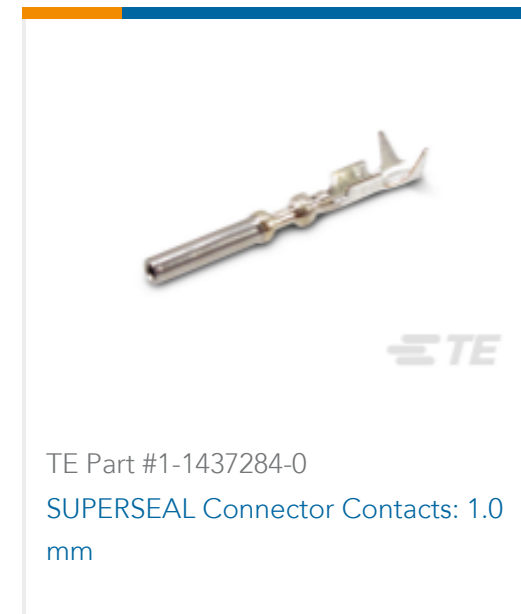

Documents

Product Drawings

S/S REC CONTACT ASSY, AU, 0.3

Japanese

CAD Files

3D PDF

3D



Customer View Model

[ENG_CVM_CVM_3-1447221-5_C.2d_dxf.zip](#)

English

Customer View Model

[ENG_CVM_CVM_3-1447221-5_C.3d_igs.zip](#)

English

Customer View Model

[ENG_CVM_CVM_3-1447221-5_C.3d_stp.zip](#)

English

By downloading the CAD file I accept and agree to the [Terms and Conditions](#) of use.

Product Specifications

[Application Specification](#)

Japanese

Instruction Sheets

[Instruction Sheet \(non U.S.\)](#)

English

[SUPER SEAL CONNECTOR PLUG HOUSING CONNECTOR](#)

English

[Straight Action Hand Tool for Super Seal Receptacle Contact](#)

Japanese

[Instruction Sheet \(non U.S.\)](#)

Japanese