

3-1447221-4 ✓ ACTIVE

AMP | SUPERSEAL 1.0mm

TE Internal #: 3-1447221-4

Automotive Terminals, Socket, Pin Diameter 1 mm [.039 in], 20

AWG Wire Size, .5 mm² Wire Size, Sealable, Family Seal,

SUPERSEAL 1.0mm

[View on TE.com >](#)



Terminals & Splices > Automotive Terminals > SUPERSEAL Connector Contacts: 1.0 mm



Terminal Type: **Socket**

Mating Pin Diameter: **1 mm [.039 in]**

Terminal Transmits: **0 – 24 A (Low Power)**

Wire Size: **.5 mm²**

[All SUPERSEAL Connector Contacts: 1.0 mm \(6\)](#)

Features

Product Type Features

Receptacle Style	180°
Sealable	Yes
Primary Locking Feature	Clean Body

Body Features

Terminal Seal Type	Family Seal
--------------------	-------------

Contact Features

Contact Size	1mm
Contact Fabrication	Stamped & Formed
Wire Contact Termination Area Plating Material	Tin
Typical Current Rating	6 A
Crimp Type	F-Crimp
Terminal Type	Socket
Mating Pin Diameter	1 mm [.039 in]



Interface Plating	Gold (Au)
-------------------	-----------

Termination Features

Termination Method to Wire & Cable	Crimp
Product Terminates To	Wire

Dimensions

Compatible Insulation Diameter Range	1.6 – 1.9 mm [.063 – .075 in]
Wire Size	.5 mm ²
Wire Size Search	20 AWG

Usage Conditions

Insulation Option	Uninsulated
Operating Temperature (Max)	80 °C, 85 °C, 90 °C, 100 °C, 105 °C, 110 °C, 120 °C, 125 °C, 130 °C [176 °F][185 °F][194 °F][212 °F][221 °F][230 °F][248 °F][257 °F][266 °F]
Operating Temperature Range	-30 – 130 °C [-22 – 266 °F]

Operation/Application

Compatible With Wire Base Material	Copper
------------------------------------	--------

Packaging Features

Packaging Quantity	7000
Packaging Method	Reel

Other

Terminal Transmits	0 – 24 A (Low Power)
--------------------	----------------------

Product Compliance

[For compliance documentation, visit the product page on TE.com>](#)

EU RoHS Directive 2011/65/EU	Compliant
EU ELV Directive 2000/53/EC	Compliant
China RoHS 2 Directive MIIT Order No 32, 2016	No Restricted Materials Above Threshold
EU REACH Regulation (EC) No. 1907/2006	Current ECHA Candidate List: JUNE 2023 (235) Candidate List Declared Against: JUNE 2023 (235) Does not contain REACH SVHC
Halogen Content	Low Halogen - Br, Cl, F, I < 900 ppm per homogenous material. Also BFR/CFR/PVC

Free

Solder Process Capability

Not applicable for solder process capability

Product Compliance Disclaimer

This information is provided based on reasonable inquiry of our suppliers and represents our current actual knowledge based on the information they provided. This information is subject to change. The part numbers that TE has identified as EU RoHS compliant have a maximum concentration of 0.1% by weight in homogenous materials for lead, hexavalent chromium, mercury, PBB, PBDE, DBP, BBP, DEHP, DIBP, and 0.01% for cadmium, or qualify for an exemption to these limits as defined in the Annexes of Directive 2011/65/EU (RoHS2). Finished electrical and electronic equipment products will be CE marked as required by Directive 2011/65/EU. Components may not be CE marked. Additionally, the part numbers that TE has identified as EU ELV compliant have a maximum concentration of 0.1% by weight in homogenous materials for lead, hexavalent chromium, and mercury, and 0.01% for cadmium, or qualify for an exemption to these limits as defined in the Annexes of Directive 2000/53/EC (ELV). Regarding the REACH Regulation, the information TE provides on SVHC in articles for this part number is based on the latest European Chemicals Agency (ECHA) 'Guidance on requirements for substances in articles' posted at this URL: <https://echa.europa.eu/guidance-documents/guidance-on-reach>

Compatible Parts



TE Part # CAT-SU763-CH8172
SUPERSEAL Connector Housings: 1.0 mm



TE Part # 1976144-1
SDE COMMERCIAL HAND TOOL



TE Part # 2305570-1
Strip Terminal Cutter-Side Feed-No Crimp



TE Part # 1976144-2
SDE COMMERCIAL DIE



TE Part # 2-2151705-1
OCEAN_2.0_Applicator-S-063F091O



TE Part # 2151705-1
OCEAN_2.0_Applicator-S-063F091O



TE Part # 2151705-2
OCEAN_2.0_Applicator-S-063F091O



TE Part # 7-2151705-1
OCEAN_2.0_Applicator-S-063F091O



TE Part # 7-2151705-2
OCEAN_2.0_Applicator-S-063F091O



KIT
TE Part # 7-2151705-7
OCEAN_2.0_SPARE_PART_KIT-063F091O



TE Part # 2-2151705-2
OCEAN_2.0_Applicator-S-063F091O

Also in the Series | **SUPERSEAL 1.0mm**

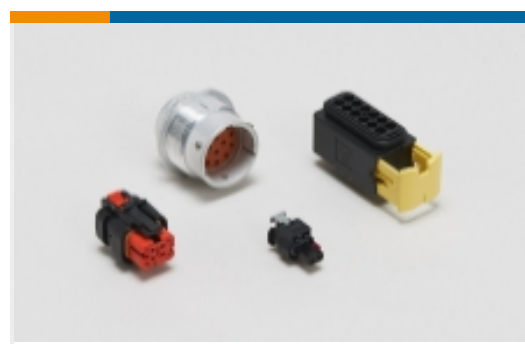

Automotive Housings(12)

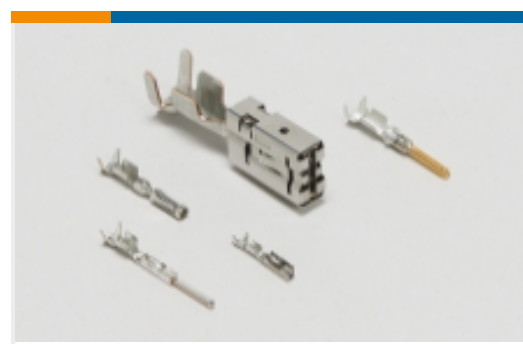

Automotive Terminals(6)



Connector Seals & Cavity Plugs(1)

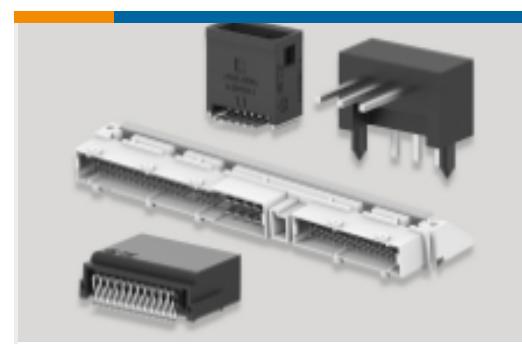

PCB Headers & Receptacles(30)

Customers Also Bought

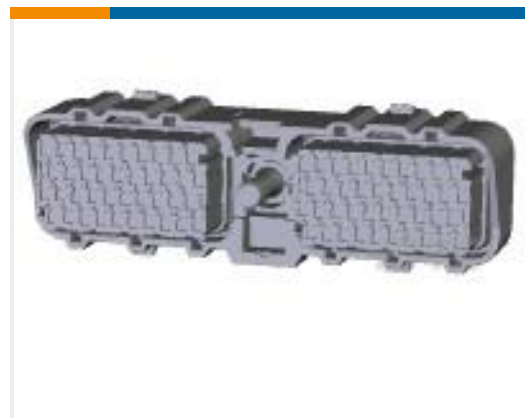

TE Part #178411-6
80P PLUG HSG ASSY FOR 120P ECU



TE Part #3-1437290-8
SUPERSEAL Connector Housings: 1.0 mm

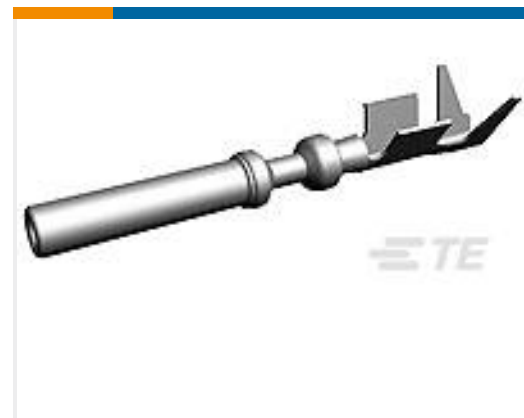

TE Part #3-1447221-3
S/S REC CONTACT ASSY, AU, 0.75~1.25



TE Part #175267-2
040 REC (M) FOR 100P PMC



TE Part #T4151320005-003
RPC-M12-FS-5CON-PUR-1.5

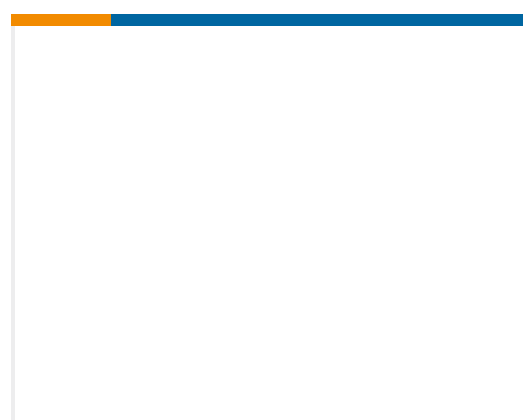

TE Part #1SNA607029R0100
R910 M 4/9 R111-12VDC (GRIS ABB)

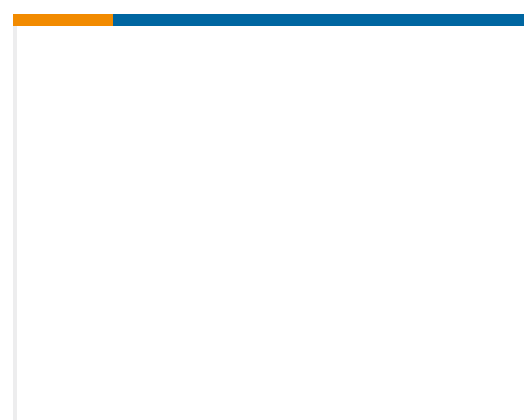

TE Part #2050707-1
CE BOX ASSEMBLY FOR K80



TE Part #CN9128-000
B-155-9001-5000

Documents

Product Drawings

S/S REC CONTACT ASSY, AU, 0.5

English

CAD Files

3D PDF

3D

Customer View Model

[ENG_CVM_CVM_3-1447221-4_C.2d_dxf.zip](#)

English

Customer View Model

[ENG_CVM_CVM_3-1447221-4_C.3d_igs.zip](#)

English

Customer View Model

[ENG_CVM_CVM_3-1447221-4_C.3d_stp.zip](#)

English

By downloading the CAD file I accept and agree to the [Terms and Conditions](#) of use.



Datasheets & Catalog Pages

ICT Terminals and Connectors Catalogue

English

CONNECTOR SELECTOR

English

Product Specifications

Application Specification

English

Receptacle Contact, Super Seal Connector

Japanese

Application Specification

Japanese

Super Seal Connector

Japanese

Application Specification

Japanese

Application Specification

English

Instruction Sheets

SUPER SEAL CONNECTOR RECEPTACLE CONTACT HAND CRIMPING TOOL

Japanese

Instruction Sheet (non U.S.)

Japanese

Instruction Sheet (non U.S.)

English

SUPER SEAL CONNECTOR PLUG HOUSING CONNECTOR

English