

3-100525-2 ✓ ACTIVE

Z-PACK | Z-PACK 2mm HM

TE Internal #: 3-100525-2

Backplane Coding Keys, Plug, Coding Key Number 1567, Z-PACK
2mm HM

[View on TE.com >](#)



Connectors > PCB Connectors > Backplane Connectors > Backplane Coding Keys

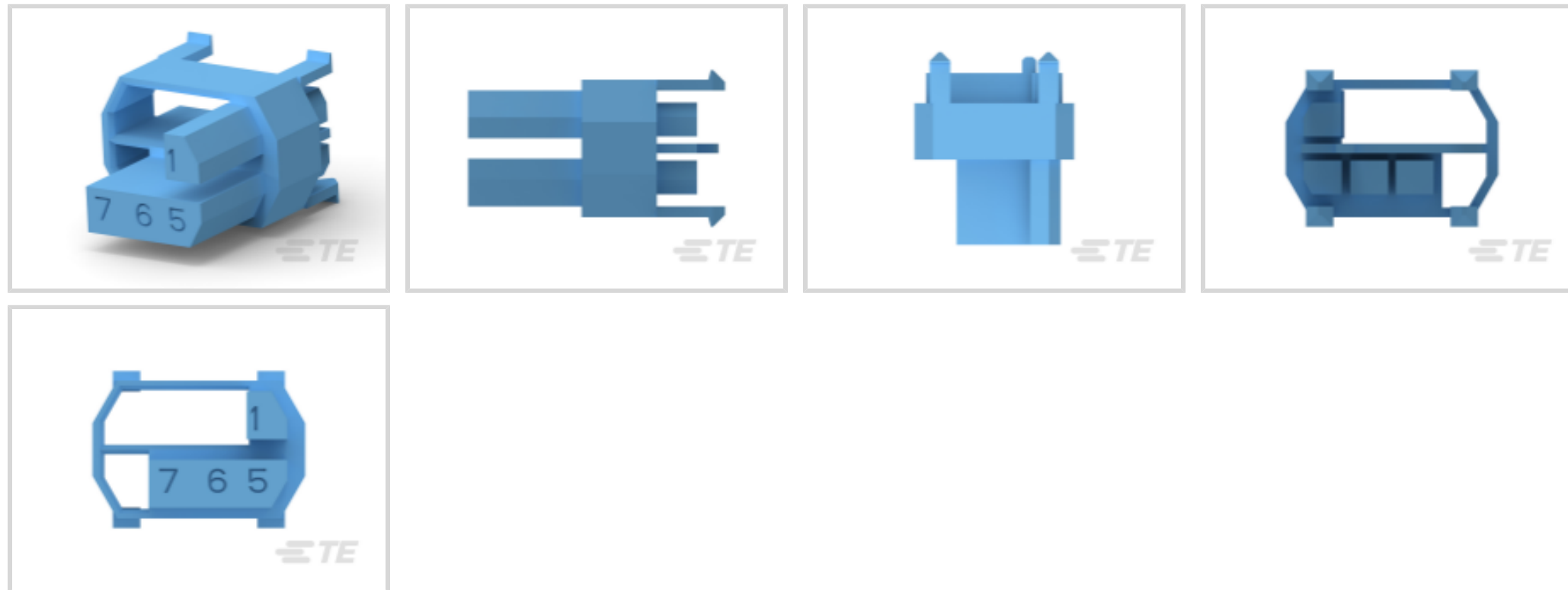

Compatible With Connector Style: **Plug**

Coding Key Number: **1567**

Features

Body Features

Coding Key Color	Brilliant Blue
------------------	----------------

Usage Conditions

Compatible With Backplane Connector Type	Type A, Type D, Type L, Type M
Compatible With Connector Style	Plug

Industry Standards

CompactPCI Application	CPCI 5.0V
------------------------	-----------

Packaging Features

Packaging Quantity	500
Packaging Method	Bag

Other

Coding Key Number	1567
-------------------	------

Product Compliance

[For compliance documentation, visit the product page on TE.com>](#)

EU RoHS Directive 2011/65/EU	Compliant
EU ELV Directive 2000/53/EC	Compliant



China RoHS 2 Directive MIIT Order No 32, 2016	No Restricted Materials Above Threshold
EU REACH Regulation (EC) No. 1907/2006	Current ECHA Candidate List: JUNE 2023 (235) Candidate List Declared Against: JUNE 2023 (235) Does not contain REACH SVHC
Halogen Content	Low Halogen - Br, Cl, F, I < 900 ppm per homogenous material. Also BFR/CFR/PVC Free
Solder Process Capability	Not applicable for solder process capability

Product Compliance Disclaimer

This information is provided based on reasonable inquiry of our suppliers and represents our current actual knowledge based on the information they provided. This information is subject to change. The part numbers that TE has identified as EU RoHS compliant have a maximum concentration of 0.1% by weight in homogenous materials for lead, hexavalent chromium, mercury, PBB, PBDE, DBP, BBP, DEHP, DIBP, and 0.01% for cadmium, or qualify for an exemption to these limits as defined in the Annexes of Directive 2011/65/EU (RoHS2). Finished electrical and electronic equipment products will be CE marked as required by Directive 2011/65/EU. Components may not be CE marked. Additionally, the part numbers that TE has identified as EU ELV compliant have a maximum concentration of 0.1% by weight in homogenous materials for lead, hexavalent chromium, and mercury, and 0.01% for cadmium, or qualify for an exemption to these limits as defined in the Annexes of Directive 2000/53/EC (ELV). Regarding the REACH Regulation, the information TE provides on SVHC in articles for this part number is based on the latest European Chemicals Agency (ECHA) 'Guidance on requirements for substances in articles' posted at this URL: <https://echa.europa.eu/guidance-documents/guidance-on-reach>

Compatible Parts



Also in the Series | Z-PACK 2mm HM

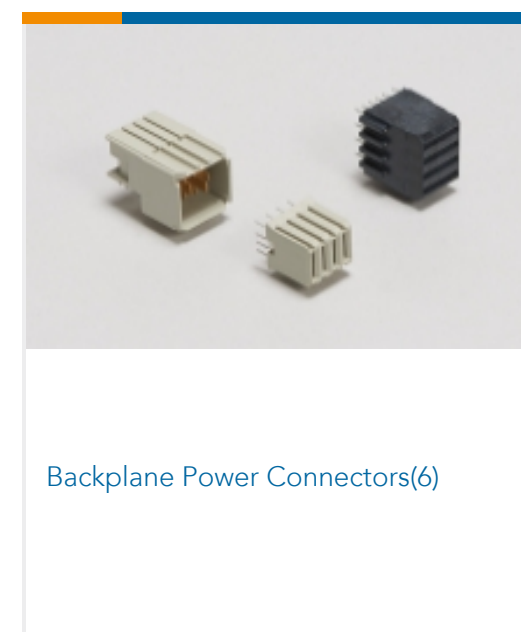
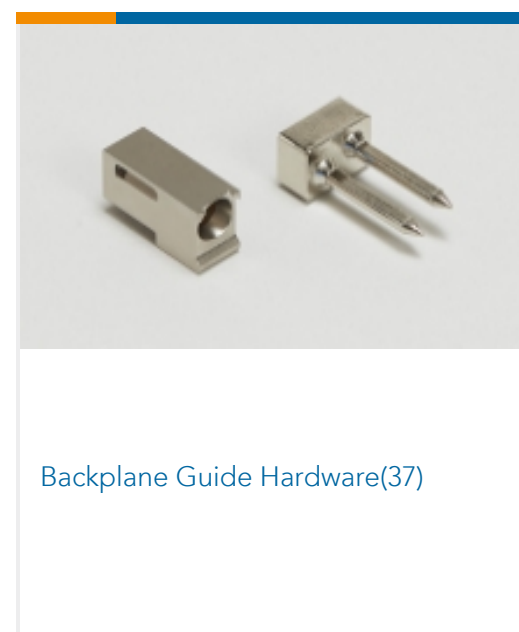
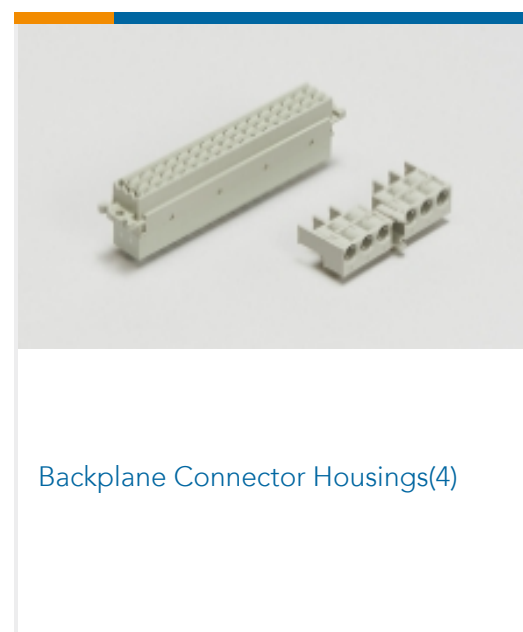
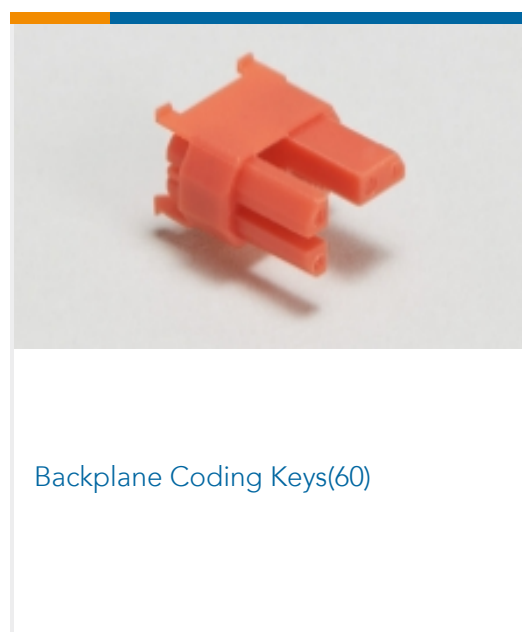



Board-to-Board Connector Contacts(2)

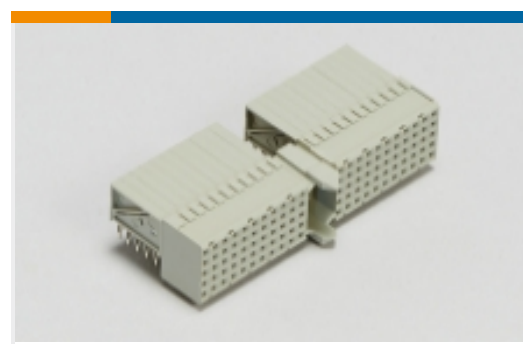

Hard Metric Backplane Connectors (269)

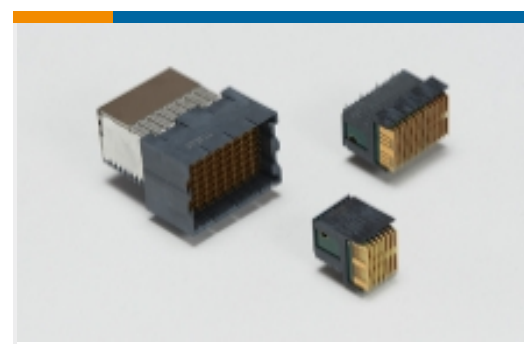

High Speed Backplane Connectors(1)



Insertion & Extraction Tools(2)

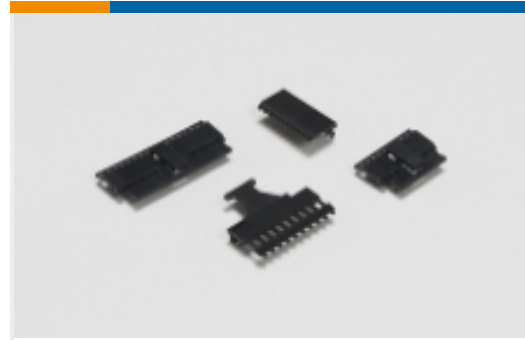

PCB Connector Covers(4)



PCB Connector Shrouds(39)



PCB Ferrules & Shields(19)



Rectangular Power Connectors(87)

Customers Also Bought

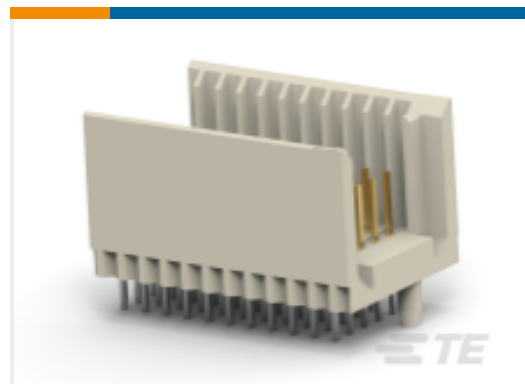

TE Part #5188835-1
Hard Metric Male Connector:
Traditional Backplane, Mezzanine,
2mm



TE Part #5352068-1
HM Receptacle Connector: Traditional
Backplane, Coplanar, 2mm



TE Part #5535090-4
ASSEMBLY, RECEPTACLE, EUROCARD,
T

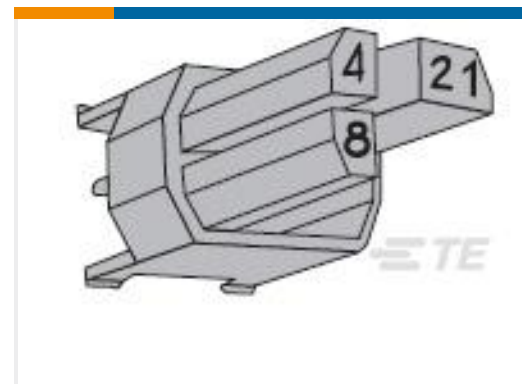

TE Part #5-100525-4
CODING DEV INSRT COLOR GREEN



TE Part #5767171-1
MICTOR RECEPT ASSY, 38 POS. TA



TE Part #5223961-1
TE UPM R/A Header 3P STD Power,
LLL



TE Part #2013022-1
SEMI-HARD TRAY DDR3 204P 4H STD



TE Part #9-1462038-8
IM02DGR=IM RELAY 140mW 4.5V

Documents

[Product Drawings](#)
[Z-PACK M.CODING KEY](#)

English

[CAD Files](#)

[3D PDF](#)

[3D](#)

[Customer View Model](#)

[ENG_CVM_CVM_3-100525-2_C.2d_dxf.zip](#)



English

Customer View Model

[ENG_CVM_CVM_3-100525-2_C.3d_igs.zip](#)

English

Customer View Model

[ENG_CVM_CVM_3-100525-2_C.3d_stp.zip](#)

English

By downloading the CAD file I accept and agree to the [Terms and Conditions](#) of use.

Product Specifications

[Application Specification](#)

English

Product Environmental Compliance

[Product Compliance Document](#)

English

[Product Compliance Document](#)

English