



MQS

TE Internal #: 284617-1

TE Internal Description: 154pos hybrid MQS .63 header 90deg sld.

High Pin Count Header

[View on TE.com >](#)

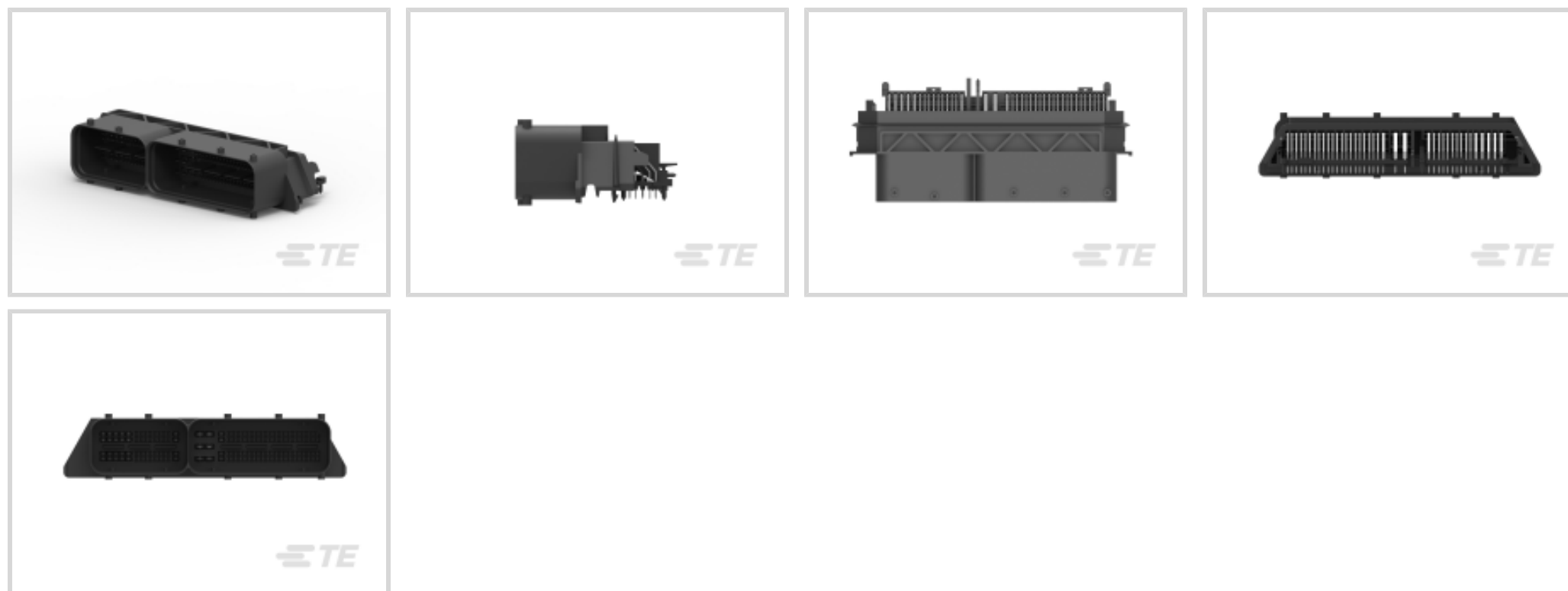

[All High Pin Count Header \(158\)](#)

Product Compliance

[For compliance documentation, visit the product page on TE.com>](#)

EU RoHS Directive 2011/65/EU	Compliant
EU ELV Directive 2000/53/EC	Compliant
China RoHS 2 Directive MIIT Order No 32, 2016	No Restricted Materials Above Threshold
EU REACH Regulation (EC) No. 1907/2006	Current ECHA Candidate List: JUNE 2023 (235) Candidate List Declared Against: JAN 2021 (211) Does not contain REACH SVHC
Halogen Content	Low Halogen - Br, Cl, F, I < 900 ppm per homogenous material. Also BFR/CFR/PVC Free
Solder Process Capability	Wave solder capable to 240°C

Product Compliance Disclaimer

This information is provided based on reasonable inquiry of our suppliers and represents our current actual knowledge based on the information they provided. This information is subject to change. The part numbers that TE has identified as EU RoHS compliant have a maximum concentration of 0.1% by weight in homogenous materials for lead, hexavalent chromium, mercury, PBB, PBDE, DBP, BBP, DEHP, DIBP, and 0.01% for cadmium, or qualify for an exemption to these limits as defined in the Annexes of Directive 2011/65/EU (RoHS2). Finished electrical and electronic equipment products will be CE marked as required by Directive 2011/65/EU. Components may not be CE marked. Additionally, the part numbers that TE has identified as EU ELV compliant have a maximum concentration of 0.1% by weight in homogenous materials for lead, hexavalent chromium, and mercury, and 0.01% for cadmium, or qualify for an exemption to these limits as defined in the Annexes of Directive 2000/53/EC (ELV). Regarding the REACH Regulation, the information TE provides on SVHC in articles for this part number is based on the latest European Chemicals Agency (ECHA) 'Guidance on requirements for substances in articles' posted at this URL: <https://echa.europa.eu/guidance-documents/guidance-on-reach>

Compatible Parts



TE Part # CAT-M8793-CH8172
MQS, CONNECTOR HOUSING



TE Part # 1-1355122-2
SHIELD, 60POSN. RECEPTACLE HOU



TE Part # 1394910-2
SHIELD, 60POSN. RECEPTACLE HOUSING



TE Part # 1394911-1
ABDECKKAPPE F.94P

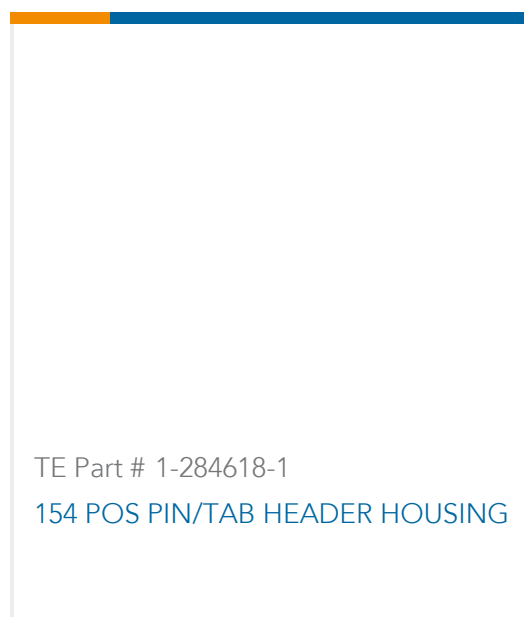

TE Part # 1-284618-1
154 POS PIN/TAB HEADER HOUSING

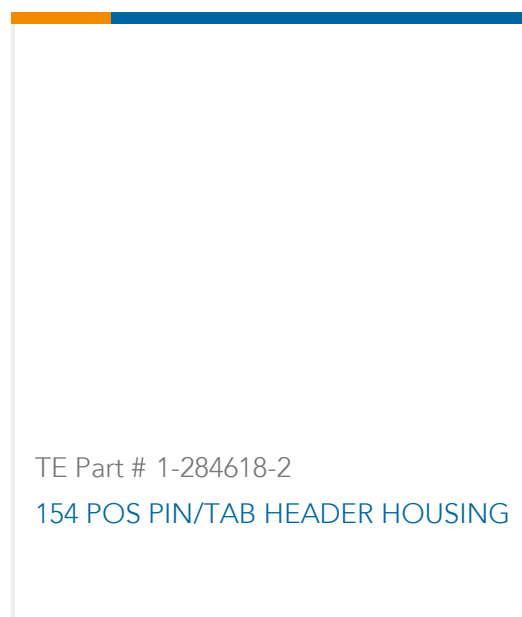

TE Part # 1-284618-2
154 POS PIN/TAB HEADER HOUSING

Also in the Series | MQS



Automotive Connector Caps & Covers (138)



Automotive Connector EMC Shielding (3)



Automotive Connector Locks & Position Assurance(30)



Automotive Housings(507)

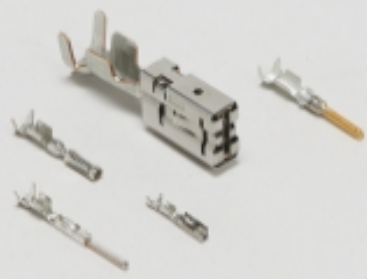

Automotive Terminals(104)



Connector Seals & Cavity Plugs(31)



Insertion & Extraction Tools(42)



Other Automotive Connector Accessories(10)



PCB Headers & Receptacles(213)

Customers Also Bought

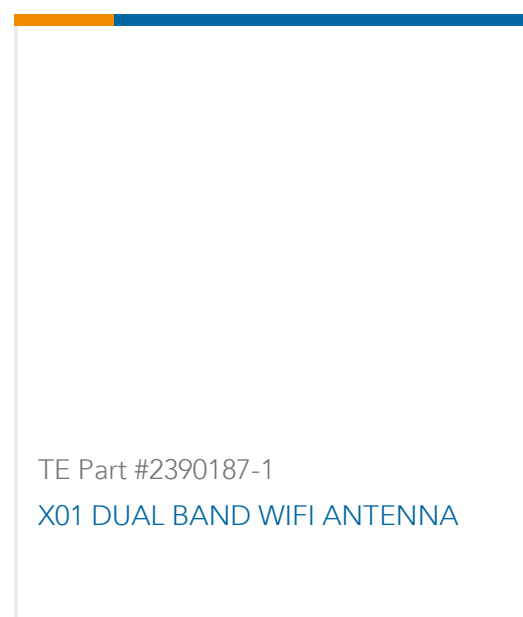
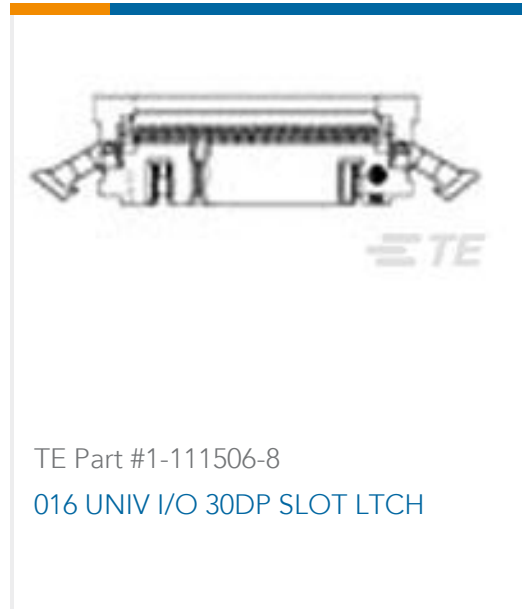

Documents

Product Drawings

154pos hybrid MQS .63 header 90deg sld.

English

CAD Files

Customer View Model

[ENG_CVM_CVM_284617-1_C.2d_dxf.zip](#)

English

3D PDF

3D

Customer View Model

[ENG_CVM_CVM_284617-1_C.3d_igs.zip](#)

English

Customer View Model

[ENG_CVM_CVM_284617-1_C.3d_stp.zip](#)

English

By downloading the CAD file I accept and agree to the [Terms and Conditions](#) of use.



Product Specifications

Product Specification

English

Instruction Sheets

Instruction Sheet (non U.S.)

English