

282404-1 ✓ ACTIVE

AMP Superseal 1.5mm Series

TE Internal #: 282404-1

Automotive Terminals, Tab, Mating Tab Width 1.5 mm [.059 in], Tab Thickness .8 mm [.031 in], 22 – 20 AWG Wire Size, AMP Superseal 1.5mm Series

[View on TE.com >](#)



Terminals & Splices > Automotive Terminals > AMP SUPERSEAL 1.5MM, RECEPTACLE AND TAB

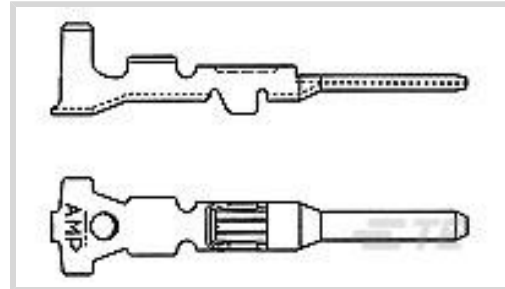

Terminal Type: **Tab**

Mating Tab Width: **1.5 mm [.059 in]**

Mating Tab Thickness: **.8 mm [.031 in]**

Terminal Transmits: **0 – 24 A (Low Power)**

Wire Size: **22 – 20 AWG**

[All AMP SUPERSEAL 1.5MM, RECEPTACLE AND TAB \(17\)](#)

Features

Product Type Features

Sealable	Yes
Primary Locking Feature	Clean Body

Body Features

Terminal Seal Type	Single Wire Seal (SWS)
--------------------	------------------------

Contact Features

Contact Size	1.5mm
Contact Fabrication	Stamped & Formed
Wire Contact Termination Area Plating Material	Tin
Typical Current Rating	6 A
Crimp Type	F-Crimp
Terminal Type	Tab
Mating Tab Width	1.5 mm[.059 in]
Mating Tab Thickness	.8 mm[.031 in]
Interface Plating	Tin (Sn)

Termination Features

Termination Method to Wire & Cable	Crimp
Product Terminates To	Wire



Dimensions

Compatible Insulation Diameter Range	1.2 – 1.6 mm [.055 – .067 in]
Wire Size	.35 – .5 mm ²
Wire Size Search	20 AWG, 21 AWG, 22 AWG

Usage Conditions

Insulation Option	Uninsulated
Operating Temperature (Max)	80 °C, 85 °C, 90 °C, 100 °C, 105 °C, 110 °C, 120 °C, 125 °C [176 °F][185 °F][194 °F][212 °F][221 °F][230 °F][248 °F][257 °F]
Operating Temperature Range	-40 – 125 °C [-40 – 257 °F]

Operation/Application

Compatible With Wire Base Material	Copper
------------------------------------	--------

Packaging Features

Packaging Quantity	4000
Packaging Method	Reel

Other

Terminal Transmits	0 – 24 A (Low Power)
--------------------	----------------------

Product Compliance

[For compliance documentation, visit the product page on TE.com>](#)

EU RoHS Directive 2011/65/EU	Compliant
EU ELV Directive 2000/53/EC	Compliant
China RoHS 2 Directive MIIT Order No 32, 2016	No Restricted Materials Above Threshold
EU REACH Regulation (EC) No. 1907/2006	Current ECHA Candidate List: JUNE 2023 (235) Candidate List Declared Against: JUNE 2023 (235) Does not contain REACH SVHC
Halogen Content	Low Halogen - Br, Cl, F, I < 900 ppm per homogenous material. Also BFR/CFR/PVC Free
Solder Process Capability	Not applicable for solder process capability

Product Compliance Disclaimer

This information is provided based on reasonable inquiry of our suppliers and represents our current actual knowledge based on the information they provided. This information is subject to change. The part numbers that TE has identified as

EU RoHS compliant have a maximum concentration of 0.1% by weight in homogenous materials for lead, hexavalent chromium, mercury, PBB, PBDE, DBP, BBP, DEHP, DIBP, and 0.01% for cadmium, or qualify for an exemption to these limits as defined in the Annexes of Directive 2011/65/EU (RoHS2). Finished electrical and electronic equipment products will be CE marked as required by Directive 2011/65/EU. Components may not be CE marked. Additionally, the part numbers that TE has identified as EU ELV compliant have a maximum concentration of 0.1% by weight in homogenous materials for lead, hexavalent chromium, and mercury, and 0.01% for cadmium, or qualify for an exemption to these limits as defined in the Annexes of Directive 2000/53/EC (ELV). Regarding the REACH Regulation, the information TE provides on SVHC in articles for this part number is based on the latest European Chemicals Agency (ECHA) 'Guidance on requirements for substances in articles' posted at this URL: <https://echa.europa.eu/guidance-documents/guidance-on-reach>

Compatible Parts



TE Part # CAT-AM71-CH8172
AMP SUPERSEAL 1.5MM,
CONNECTOR HOUSING



TE Part # 9-1579007-1
EXTRACTION TOOL

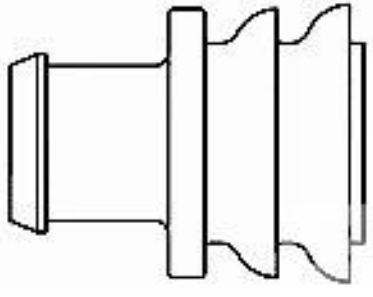

TE Part # 282081-1
RUBBER PLUG



TE Part # 281934-4
SINGLE WIRE SEAL



TE Part # 2305570-1
Strip Terminal Cutter-Side Feed-No
Crimp



TE Part # CAT-AM71-T273
AMP SUPERSEAL 1.5MM,
RECEPTACLE AND TAB



TE Part # 1745099-1
AMP SUPERSEAL 1,5 SRS. 2 POS. TAB
ASS'Y



KIT
REPRESENTATION ONLY

TE Part # 7-2151855-7
OCEAN_2.0_SPARE_PART_KIT-
080F145O



TE Part # 2151855-1
OCEAN_2.0_Applicator-S-080F145O



TE Part # 2151855-2
OCEAN_2.0_Applicator-S-080F145O



TE Part # 282439-1
MINI MIC RCPT. CONT. 0,5-1



TE Part # 5-2151855-1
OCEAN_2.0_APPLICATION-S-
080F145O



TE Part # 5-2151855-2
OCEAN_2.0_APPLICATION-S-
080F145OA



TE Part # 7-2151855-1
OCEAN_2.0_Applicator-S-080F145O



TE Part # 7-2151855-2
OCEAN_2.0_Applicator-S-080F145O



KIT
REPRESENTATION ONLY

TE Part # 7-2836565-7
OC-080F145O-752-
CRIMPTOOLINGKIT



Also in the Series | AMP Superseal 1.5mm Series

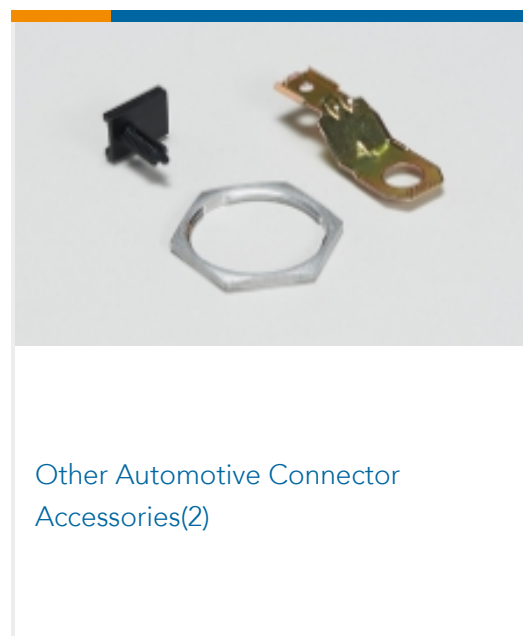
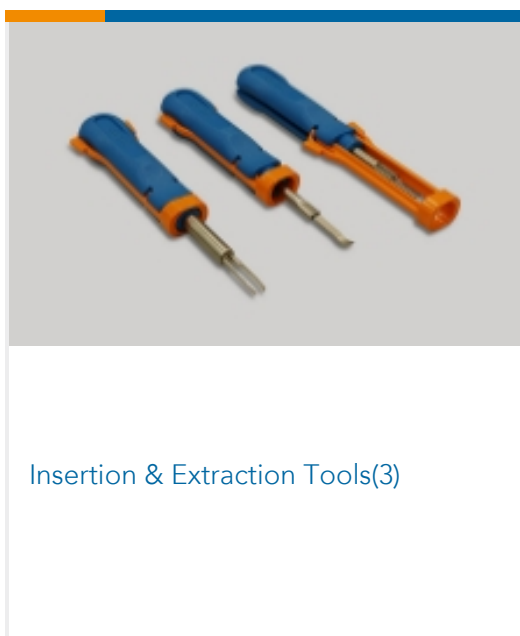
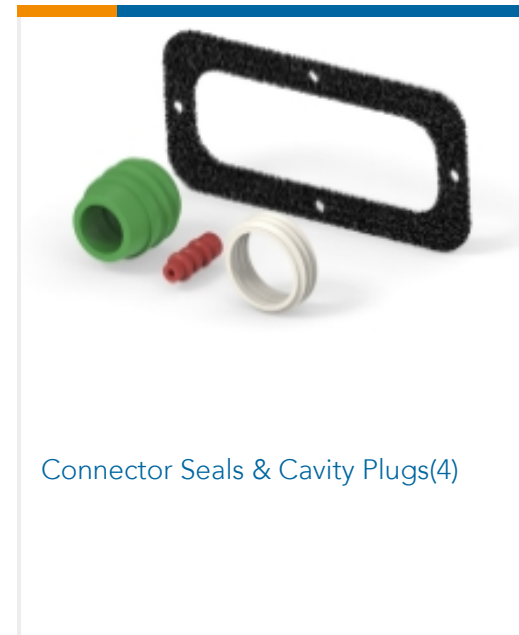
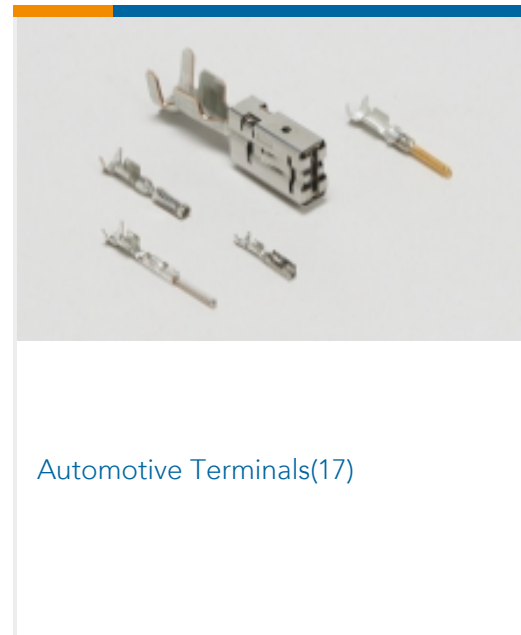
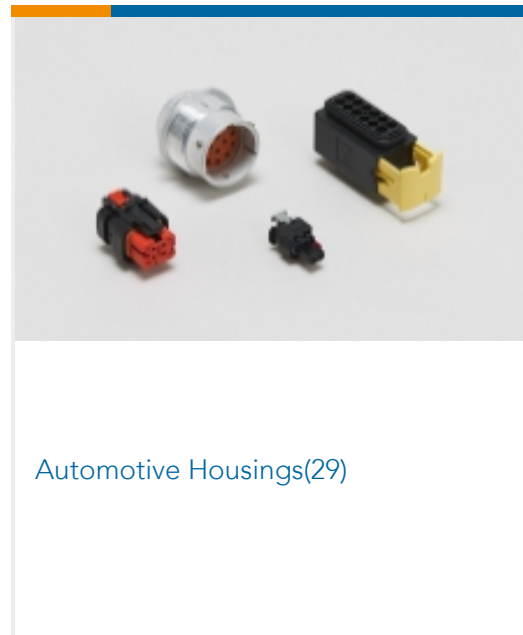
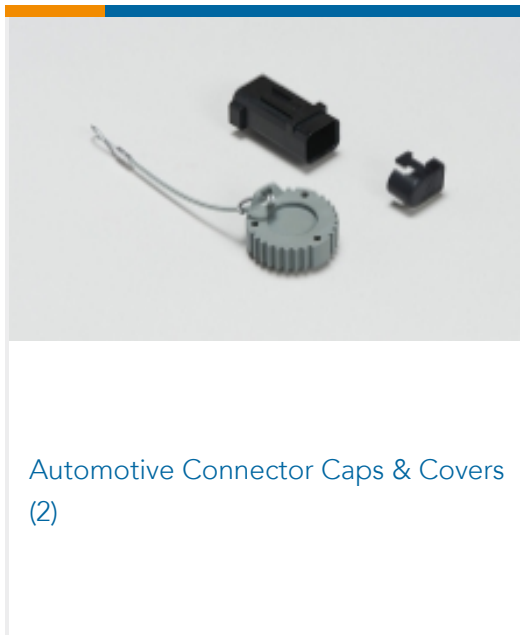

Customers Also Bought

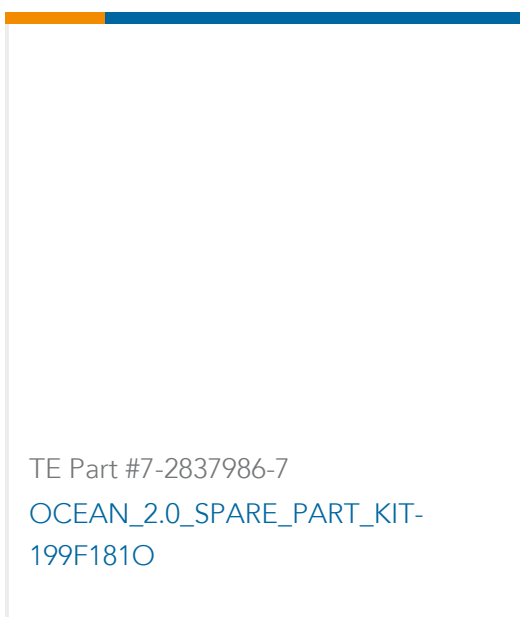
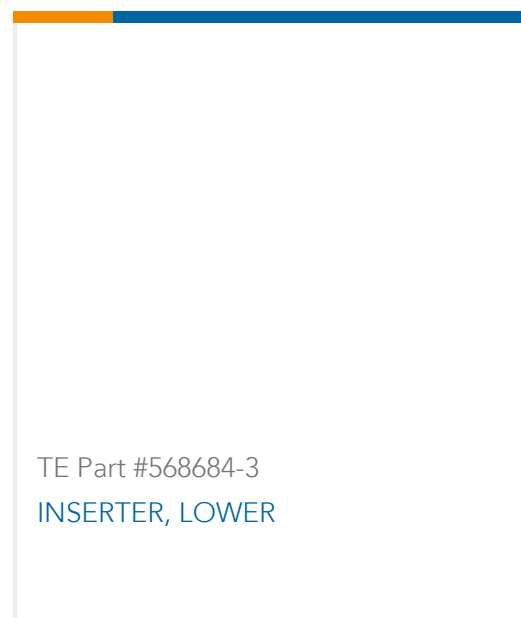
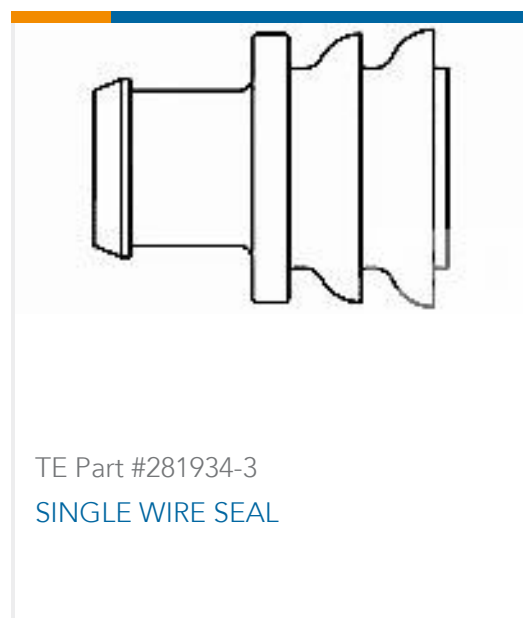



Documents

Product Drawings

MINI MIC SRS TAB CONT

English

CAD Files

3D PDF

3D

Customer View Model

[ENG_CVM_CVM_282404-1_A.2d_dxf.zip](#)

English

Customer View Model

[ENG_CVM_CVM_282404-1_A.3d_igs.zip](#)

English

Customer View Model

[ENG_CVM_CVM_282404-1_A.3d_stp.zip](#)

English

By downloading the CAD file I accept and agree to the [Terms and Conditions](#) of use.

Datasheets & Catalog Pages

AMP SUPERSEAL 1.5mm Connector System

English

ICT Terminals and Connectors Catalogue

English

Product Specifications

Application Specification

English

Application Specification

English

Instruction Sheets

Hand application tool P/N 785353-1

English

Instruction Sheet (non U.S.)

English